



SEWOO

SEWOO TECH CO.,LTD.

Doosung BD, 689-20, Geumjung-dong, Gunpo-si, Gyeonggi-do, 435-862 South Korea
TEL : +82-31-459-8200 FAX : +82-31-459-8880
www.miniprinter.com



MODEL : LK-P30W

MOBILE PRINTER

Table of Contents

1. Unpacking	2
2. Product overview	3
3. Usage and Installation	4
3-1. Control panel usage	4
3-2. Battery Installation	5
3-3. Battery removal	6
3-4. Battery charging	7
3-5. Battery charger usage	8
3-6. Usage of Cigar Jack for charging	9
3-7. Belt clip usage	10
3-8. Roll paper installation	11
3-9. Leather case usage	12
3-10. Self test	13
3-11. MSR usage	15
3-12. IC CARD usage	16
4. Peripherals connection	17
4-1. Wifi(802.11b/g) Connection	17
4-2. Interface cable connection	18
5. Printer specification	19
5-1. Specification	19
6. CPCL Command Compatibility	21
7. Certification	24
8. Setting up the software	26



Disposal of Old Electrical&Electronic Equipment(Applicable in the European Union and other European countries with separate collection systems)

This symbol on the product or on its packaging indicates that this product shall not be treated as household waste.

Instead it shall be handed over to the applicable collection point for the recycling of electrical and electronics equipment. For more detailed information about recycling of this product, please contact your local city office, your household waste disposal service or the shop where you purchased the product.

1. Unpacking

Standard



Printer

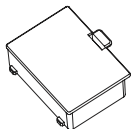

Battery

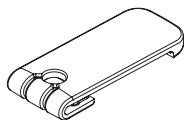

Belt Buckle



Charger

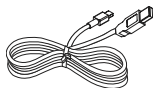

USB Cable Shielded

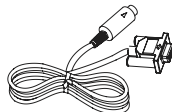

Serial Cable

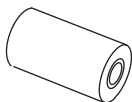

Roll paper



CD



Quick Manual

Optional



Battery Holder (Cradle)



Cigar Jack Charger

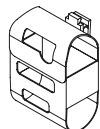

Leather case

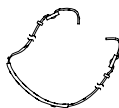

Shoulder strip

2. Product overview

Front

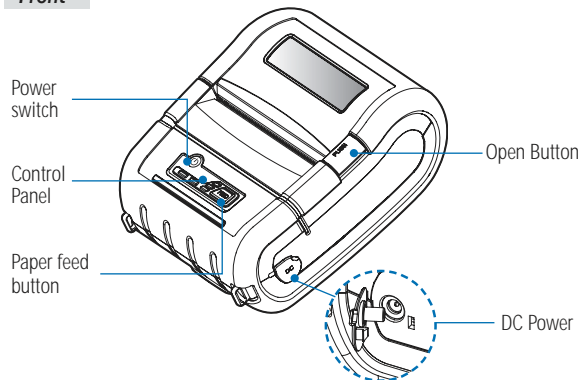



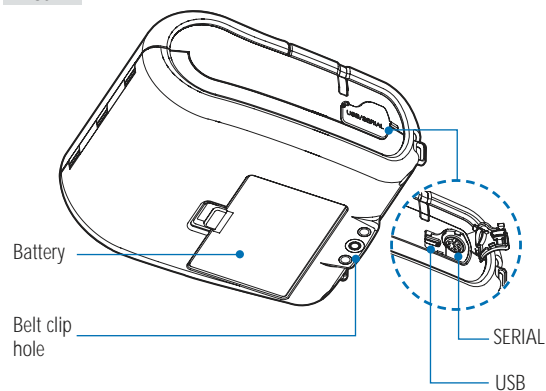

Rear

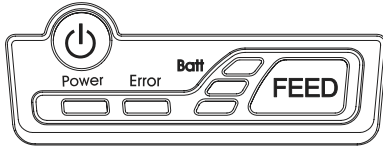

3. Usage and Installation

3-1 Control panel usage



Button	Name	function
	Power button	This button is used to turn the printer on and off. When the printer is off, press this button for approximately 3 seconds and it will turn on the power. When you press this button in a state that the printer is on, the printer will turn off.
	Paper Feed Button	Paper output can be done manually by pressing this button. Additionally, self-testing and Hexadecimal Dumping can be processed. 1. Refer to "3-10" for self test information. 2. Refer to the service manual regarding Hexadecimal Dumping.
	Battery Status Lamp	1. If the Batt, LED are Lit, the battery is fully charged. 2. If you can hear beeping sound and LED light is turned off, it means that the battery is at the lowest level. 3. If the battery is not charged at all, the printer turns off automatically.
	Error Lamp	If the red light is turned on, it means there is no paper roll or the paper cover is open.

3-2 Battery Installation

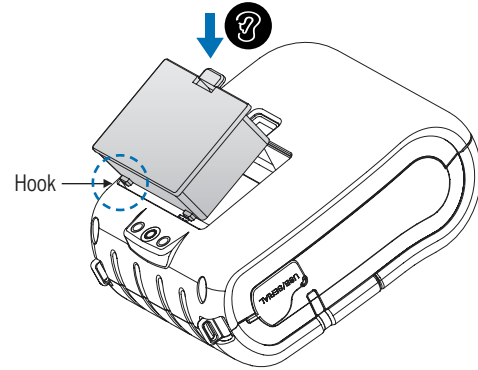

1. Align battery hook as shown in the picture
2. Push the battery into the printer until it locks in place.

NOTE

As the battery is not charged at the time of your purchase, charge the battery prior to using the printer
(Battery charger or Cradle can be used to charge)

CAUTION

Risk of explosion if battery is replaced by an incorrect type.
Dispose of used batteries according to the instructions

3-3 Battery removal

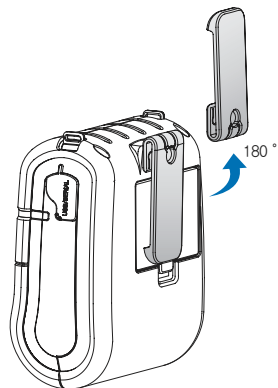

Put up the Belt clip hole turning 180 degree.

1
2

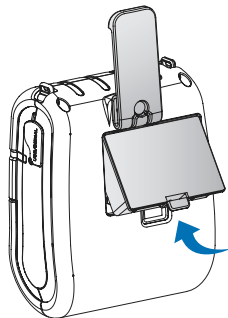

After putting up the belt clip, remove the battery holding it up as shown above.

3-4 Battery charging

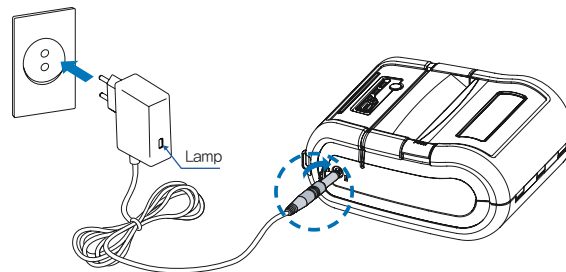

1. Be sure that the printer is turned off
2. After open the DC JACK cover, insert DC JACK into the printer.
3. Plug the power cord to electrical outlet.

3-4-1 The status of lamp in charging

Status	charging	charging complete
Charging Lamp	Red	Green

NOTE

1. Unless the exclusive charger is used provided by the manufacturer, the printer can be damaged, and the manufacturer is not liable for the consequential damage.
2. Before removing the battery, make sure that power is turned off.
3. Printer does not work in the status of being connected with charger only.
4. The battery should be installed to operate printer.
5. While charging, do not turn on the power.
6. Do not operate the print while charging the battery.
7. Do not connect the charger while the printer is operated.

3-5 Battery charger usage

Optional

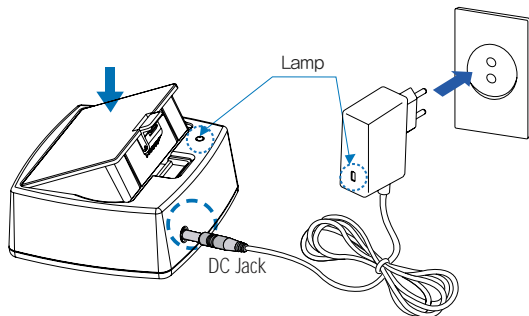

1. Insert the battery into the battery holder as shown above
2. Connect the DC JACK to the power electrical outlet.
3. Plug the power code into the electrical outlet.
4. Once the charging is completed, remove the battery from the holder.

3-5-1 The status of lamp in charging

Status	charging	charging complete
Charging Lamp	Red	Green

NOTE

In the case the battery is not fixed properly in the holder, the red lamp will be blinking, Then, extract and reinsert the battery.

3-6 Usage of Cigar Jack Charger for charging

Optional

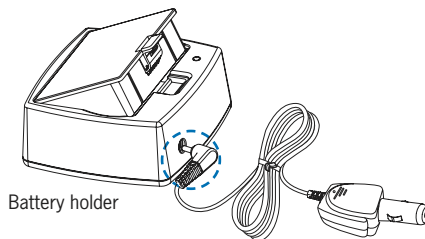
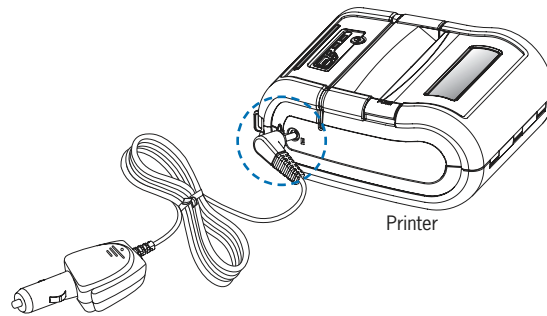

Connect the car cigar JACK charger into the printer or battery holder.

Input	12 ~ 24V
Output	8.4V 0.8 ~ 1.2A

NOTE

Use the Cigar Jack offered by the manufacturer.

3-7 Belt Clip usage

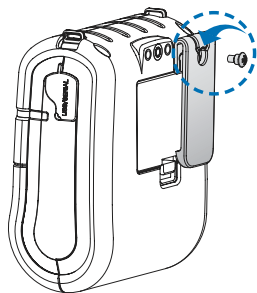

Insert the belt clip screw into the hole of Belt clip

1
2

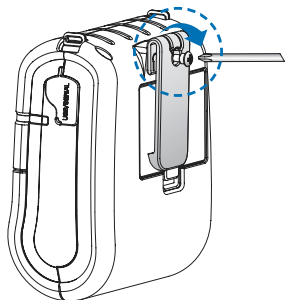

As shown in the picture, tighten the screw with a screw driver.

3-8 Roll Paper installation

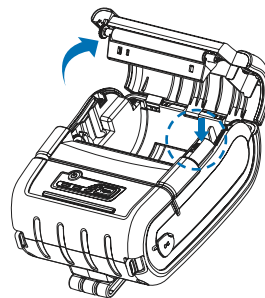

Press the PUSH button to open the paper cover

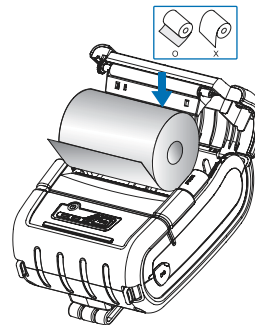

Insert the paper in the right direction

1
2
3
4

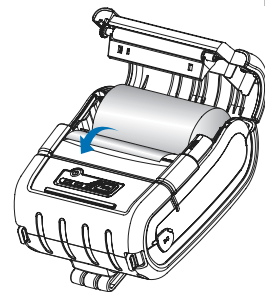

Pull a short length of paper out of the printer and close the cover.

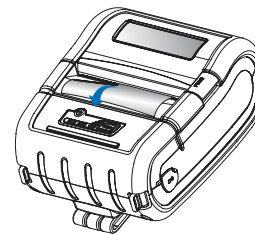

Tear off the additional paper using tear bar.

3-9 Leather case usage

Optional

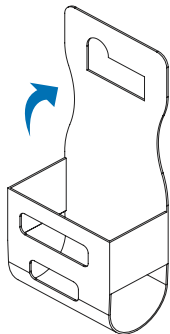

Open the leather case

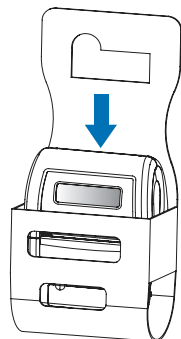

Place the printer into the leather case

1 2
3 4

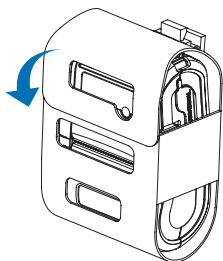

Close the Velcro and stick the cover.

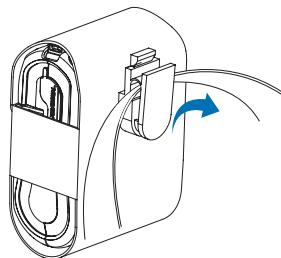

Fasten to the belt by using the clip at the rear of the leather case

3-10 Self Test

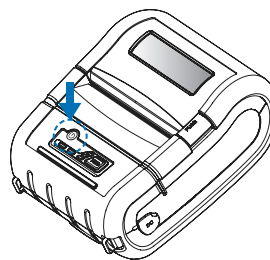

Turn off the power pressing the power button for approximately 3 seconds.

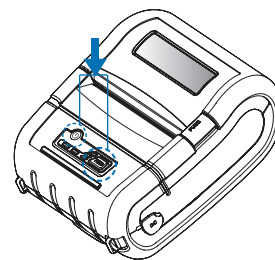

While you are pressing the FEED button, press the power button

1 2
3

NOTE

1. To print ASCII pattern additionally, press the Feed button once more
2. After printing ASCII pattern, the self test will be finished automatically.
3. If the Feed button is not pressed to print ASCII pattern, self test will be finished automatically after 30 seconds.

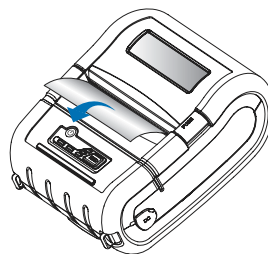

The printout is produced.

The sample of self test printout

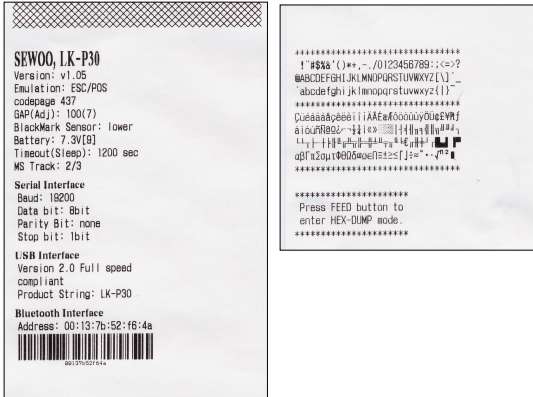

When the printer is installed initially or when you face a problem, you can run the self test and check the information about

-Control Circuit, Mechanism, Print Quality, ROM Version

After checking with self-test and no issues are found, you can examine other devices and software. This function is working independent of devices and software.

● Motor protection from being overheated

The motor should be stopped and cooled about more than 30 seconds after continuous printing 1.5 meter

3-11 MSR usage

Optional

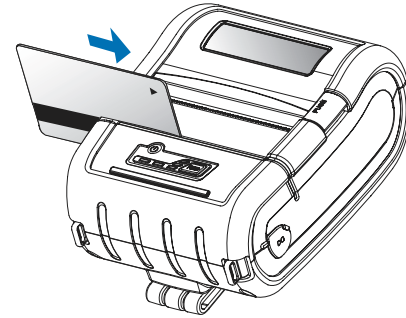

Insert and swipe the card in the direction of the arrow as shown in the picture.

3-12 IC CARD usage

Optional

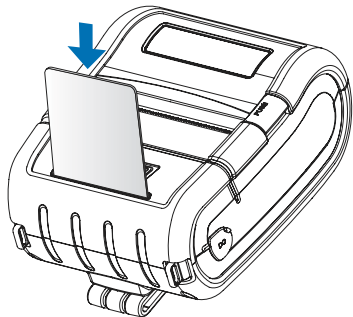

Insert the card in the direction of the arrow as shown in the picture.

4. Peripherals connection

This product can communicate with other devices via Wifi(802.11b/g) communication and cable.

4-1 Wifi(802.11b/g) Connection

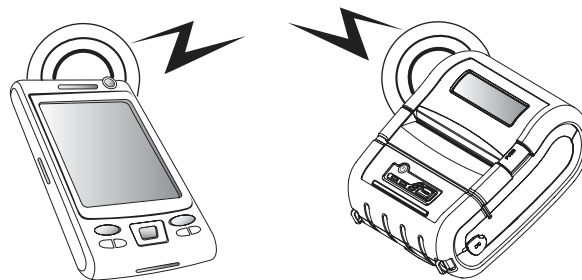

1. The Printer can be connected to devices equipped with wifi(802.11b/g) communication capacity (PDAs, PCs, etc.)
2. Use the wifi(802.11b/g) connection function supported by the device to connect to the printer.

✓ NOTE

Refer to the wifi(802.11b/g) Manual for more details on connection.

4-2 Interface Cable Connection

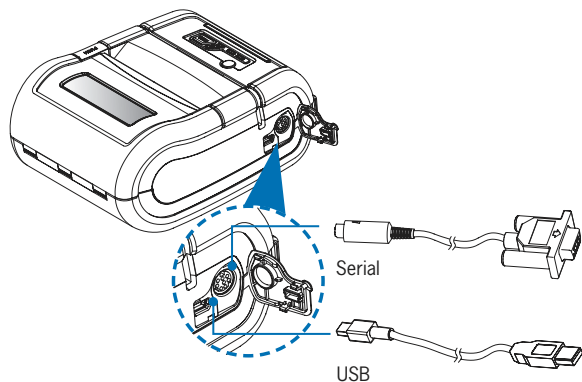

1. Connect USB or Serial cable into the cable connector on the printer.

NOTE

Use the cable offered by the manufacturer (USB, Serial)

2. Connect the interface cable into the USB or Serial port of the device (PDA, PC, etc.)

5. Pritner Specification

5-1 Specification

Printing Method	Direct Thermal	
Printing Speed	100mm/sec	
Resolution	203 DPI X 203 DPI	
Character	Font A (12X24), Font B (9X17)	
Character per line	Font A : 48pt , Font B : 64pt	
Character set	ALPHA NUMERIC Character, Extension Character	
Barcode	EAN-8, EAN-13, Code39, ITF, UPC-A, UPC-E, Codabar, Code93, Code128, PDF417(2D), MAXIcode (2D)	
Emulation	ESC/POS, CPCL, Commanl Compatible	
Driver	Window CE 4.2&5.0, Window Mobile 5.0	
Sensor	Paper End Sensor , Gap Sensor , Cover Open Sensor , Black Mark Sensor	
Paper	paper type	Thermal Paper
	width	25.4mm~79mm
	thickness	0.06mm ~ 0.09mm
	External Diameter	Max. ϕ 56mm
	Internal Diameter	12.5mm +/-0.5mm
Reliability	TPH	50km
	Battery	Continuous Printing 36min Standby: 11hours Printing length: 186m
Communications	Serial(RS-232C), USB, Wireless Lan *802.11b/g	
MSR (Optional)	Card Standard	ISO7811/2, JIS
	Track	1Track, 2Track, 3Track, JIS-II
	Magnet Head Life	300,000 Passes(minimum)

6. CPCL Command Compatibility

IC CARD (Optional)		EMV™ level one certified smart card reader
Battery Charger	input	AC100~240V, 50/60Hz
	output	8.4V , 800~1400mA
Battery	Battery type	Li-ion
	output	7.4V, 2200mAh
	Charging time	3hours 40min
Size	W X D X H(mm)	120 X 152 X 70
	W X D X H"	4.7 X 5.9 X 2.7
Weight		0.6kg
Environmental sealing		IP42
Temperature	operation	-10 ~ 50℃
	storage	-20 ~ 60℃
Humidity	operation	35 ~ 95%

NOTE

Compatible	Compatible with only commanders provided by the manufacturer.	Partially Compatible	Not Compatible
○	●	△	x

Printer Commands	Compatibility
PRINT	○
FORM	○
JOURNAL	○
UNITS	○
Comments	○
TEXT	Compatibility
TEXT	○
FONT-GROUP(FG)	○
TEXT CONCATENATION	○
MULTILINE(ML)	○
COUNT	○
SETMAG	○
SCALABLE TEXT	X
Linear Bar Codes	Compatibility
BARCODE	○
BARCODE-TEXT	○
Two-Dimensional Bar Codes	Compatibility
PDF417 (PORTABLE DATA FILE)	○
MAXICODE	○
QRCODE	●
DATAMATRIX	●
GS1(RSS)	●

Graphics	Compatibility
BOX	○
LINE	○
INVERSE-LINE	○
PATTERN	○
GRAPHICS	○
PCX	○
Advanced Commands	Compatibility
CONTRAST	○
TOPE	○
JUSTIFICATION	○
PAGE-WIDTH	○
PACE	○
NO-PACE	○
WAIT	○
REWIND	X
TENSION	X
SPEED	○
SETSP	○
ON-OUT-OF-PAPER	X
ON-FEED	○
PREFEED	○
POSTFEED	○
PRESENT-AT	X
COUNTRY/CODE PAGE	○
FORMAT FILES	○
BEEP	○
CUT	X
PATIAL-CUT	X
MCR	●

Line Print Mode	Compatibility
SETLP	○
SETLF	○
Moving With X and Y Coordinates	○
LMARGIN	○
SETBOLD	○
SETSP	○
Special ASCII Characters	○
SETFF	○
SET-TOF	○
SETLP-TIMEOUT	○

7.Certification

FCC Information

This device complies with part 15 of the FCC Results. Operation is subject to the following two conditions:

- (1) This Device may not cause harmful interface, and
- (2) This device must accept any interference received, including interference that may cause undesired operation.

NOTE

This equipment has been tested and found to comply with the limits for CLASS B digital device, pursuant to Part 15 of FCC Rules. These limits are designed to provide reasonable protection against harmful interference when the equipment is operated in a commercial environment. This equipment generates, uses and can radiate radio frequency energy and, if not installed and used in accordance with the instructions, may cause harmful interference to radio communications. However, there is no guarantee that interference will not occur in a particular installation. If this equipment does cause harmful interference to radio or television reception, which can be determined by turning the equipment off and on, the user is encouraged to try correct the interference by one or more of the following measures:

- 1.1. Reorient or relocate the receiving antenna.
- 1.2. Increase the separation between the equipment and receiver.
- 1.3. Connect the equipment into an outlet on a circuit different from that to which receiver is connected.
- 1.4. Consult the dealer or experienced radio/TV technician for help.

WARNING

Conditions not expressly approved by the manufacturer could void the user's authority to operate the equipment.

CAUTION

Antenna shall be mounted in such a manner to minimize the potential for human contact during normal operation. The antenna should not be contacted during operation to avoid the possibility of exceeding the FCC radio frequency exposure limit.

The device meets the FCC requirements for radio frequency (RF) radiation exposure in the standard body worn configuration with no minimum configuration. In this configuration, which applies whether the belt clip or shoulder strap is used, the face of the printer from which paper is transported is facing away from the user's body. The standard configuration must always be used when the printer is body worn.

8. Setting up the software

Please refer to the programming manual included in CD.