

CipherLab Reference Manual

Windows Embedded Handheld 6.5

CP60 / CP60G

Version 1.01



PREFACE

COPYRIGHT

Copyright © 2013 CIPHERLAB CO., LTD.

All rights reserved

The information contained in this document, including all pictures, illustrations and software, is the proprietary information of CIPHERLAB CO., LTD. and its respective legal owners; it is protected by copyright laws and international copyright treaties, as well as other intellectual property laws and treaties, with all rights reserved.

In no event and by no part shall this document be reproduced, stored in a retrieval system, or transmitted in any form or by any means including but not limited to electronic, mechanical, photocopying, and recording without the prior written consent of CIPHERLAB CO., LTD. Any reverse engineering of software is also prohibited.

DISCLAIMER

The information herein is subject to change without notice. The information and the intellectual property herein are confidential between you and CIPHERLAB CO., LTD. and remain the exclusive property of CIPHERLAB CO., LTD. and its respective legal owners. Should you find any problems in this document, please report them to CIPHERLAB in writing. CIPHERLAB does not warrant this document is error-free.

TRADEMARK RECOGNITION

CipherLab logo is a registered trademark of CIPHERLAB CO., LTD. Windows Embedded Handheld is a registered trademark or trademark of Microsoft Corporation in the United States and/or other countries. All other brands, products and services, and trademark names are the property of their registered owners. The editorial use of these names is for identification as well as to the benefit of the owners, with no intention of infringement.

CONTACT

For product consultancy and technical support, please contact CIPHERLAB's sales representative in your local area. You may also visit CIPHERLAB web site for more information.

CIPHERLAB CO., LTD.

Website: <http://www.CipherLab.com>

FOR UNITED STATES

This equipment has been tested and found to comply with the limits for a **Class B** digital device, pursuant to Part 15 of the FCC Rules. These limits are designed to provide reasonable protection against harmful interference in a residential installation. This equipment generates, uses and can radiate radio frequency energy and, if not installed and used in accordance with the instructions, may cause harmful interference to radio communications. However, there is no guarantee that interference will not occur in a particular installation. If this equipment does cause harmful interference to radio or television reception, which can be determined by turning the equipment off and on, the user is encouraged to try to correct the interference by one or more of the following measures:

- ▶ Reorient or relocate the receiving antenna.
- ▶ Increase the separation between the equipment and receiver.
- ▶ Connect the equipment into an outlet on a circuit different from that to which the receiver is connected.
- ▶ Consult the dealer or an experienced radio/TV technician for help.

This device complies with Part 15 of the FCC Rules. Operation is subject to the following two conditions: (1) This device may not cause harmful interference, and (2) this device must accept any interference received, including interference that may cause undesired operation.

SAFETY NOTICES

RADIO WAVE EXPOSURE AND SPECIFIC ABSORPTION RATE (SAR) INFORMATION

This mobile computer model CP60G has been designed to comply with applicable safety requirements for exposure to radio waves. These requirements are based on scientific guidelines that include safety margins designed to assure the safety of all persons, regardless of age and health.

The radio wave exposure guidelines employ a unit of measurement known as the Specific Absorption Rate, or SAR. Tests for SAR are conducted using standardized methods with the phone transmitting at its highest certified power level in all used frequency bands.

While there may be differences between the SAR levels of various phone models, they are all designed to meet the relevant guidelines for exposure to radio waves.

SAR data information for residents in countries that have adopted the SAR limit recommended by the International Commission of Non-Ionizing Radiation Protection (ICNIRP), which is 2 W/kg averaged over ten (10) gram of tissue (for example European Union, Brazil and Australia):

The highest SAR value for this model phone when tested by CIPHERLAB for use at the body is 1.35 W/kg (10g).

FOR UNITED STATES

THESE PRODUCT MODELS HAVE BEEN CERTIFIED IN COMPLIANCE WITH THE GOVERNMENT'S REQUIREMENTS FOR EXPOSURE TO RADIO WAVES.

The CP60 series mobile computer has been designed to comply with applicable safety requirements for exposure to radio waves. Your mobile computer is a radio transmitter and receiver. It is designed to not exceed the limits* of exposure to radio frequency (RF) energy set by governmental authorities. These limits establish permitted levels of RF energy for the general population. The guidelines are based on standards that were developed by international scientific organizations through periodic and thorough evaluation of scientific studies. The standards include a safety margin designed to assure the safety of all individuals, regardless of age and health.

The radio wave exposure guidelines employ a unit of measurement known as the Specific Absorption Rate (SAR). Tests for SAR are conducted using standardized methods with the product transmitting at its highest certified power level in all used frequency bands. While there may be differences between the SAR levels of various product models, they are all designed to meet the relevant guidelines for exposure to radio waves.

The highest reported SAR values for body-worn accessory and simultaneous transmission are 0.76W/kg, and 1.27W/kg respectively for CP60G. The highest reported SAR values for body-worn operation are 1.03W/Kg for CP60. For body-worn operation, the product has been tested when positioned a minimum of 15 mm from the body without any metal parts in the vicinity of the product.

Before a WWAN model is available for sale to the public in the US, it must be tested and certified by the Federal Communications Commission (FCC) that it does not exceed the limit established by the government-adopted requirement for safe exposure*. The tests are performed in positions and locations (i.e., by the ear and worn on the body) as required by the FCC for each model. The FCC has granted an Equipment Authorization for this phone model with all reported SAR levels evaluated as in compliance with the FCC RF exposure guidelines. While there may be differences between the SAR levels of various phones, all mobile phones granted an FCC equipment authorization meet the government requirement for safe exposure. SAR information on this phone model is on file at the FCC and can be found under the Display Grant section of <http://www.fcc.gov/oet/fccid> after searching on FCC ID Q3N-CP60G. Additional information on SAR can be found on the Cellular Telecommunications & Internet Association (CTIA) website at <http://www.phonefacts.net>.

** In the United States and Canada, the SAR limit for mobile phones used by the public is 1.6 watts/kilogram (W/kg) averaged over one gram of tissue. The standard incorporates a margin of safety to give additional protection for the public and to account for any variations in measurements.*

FOR PRODUCT WITH LASER



CAUTION

This laser component emits FDA / IEC Class 2 laser light at the exit port. Do not stare into beam.

SAFETY PRECAUTIONS

RISK OF EXPLOSION: IF BATTERY IS REPLACED BY AN INCORRECT TYPE. DISPOSE OF USED BATTERIES ACCORDING TO THE INSTRUCTIONS.

- ▶ The use of any batteries or charging devices, which are not originally sold or manufactured by CipherLab, will void your warranty and may cause damage to human body or the product itself.
- ▶ DO NOT disassemble, incinerate or short circuit the battery.
- ▶ DO NOT expose the scanner or the battery to any flammable sources.
- ▶ For green-environment issue, it's important that batteries should be recycled in a proper way.
- ▶ Under no circumstances, internal components are self-serviceable.
- ▶ The charging and communication cradle uses an AC power adapter. A socket outlet shall be installed near the equipment and shall be easily accessible. Make sure there is stable power supply for the mobile computer or its peripherals to operate properly.

CARE & MAINTENANCE

- ▶ This mobile computer is intended for industrial use. The mobile computer is rated IP65/67, however, the mobile computer can get damaged when being exposed to extreme temperatures or soaked wet.
- ▶ When the enclosure of the mobile computer gets dirty, use a clean and wet cloth to wipe off the dust. DO NOT use/mix any bleach or cleaner. Always keep the LCD dry.
- ▶ For a liquid crystal display (LCD) or touchscreen, use a clean, non-abrasive, lint-free cloth to wipe dust off the screen. DO NOT contact the surface with any pointed or sharp object.
- ▶ If you want to put away the mobile computer for a period of time, download the collected data to a host computer, and then take out the battery pack. Store the mobile computer and battery pack separately.
- ▶ When the mobile computer resumes its work, it takes some time for the main and backup batteries to become fully charged.
- ▶ If you shall find the mobile computer malfunctioning, write down the specific scenario and consult the sales representative in your local area.

DECLARATION OF CONFORMITY



Declaration of Conformity

Manufacturer

CIPHERLAB Co., Ltd.
12F., 333, Dunhua S. Rd., Sec. 2
Taipei, Taiwan 106, R.O.C.

Tel: +886 2 8647 1166
<http://www.cipherlab.com>

European information

CipherLab GmbH
Willicher Damm 145
41066 Mönchengladbach
Germany

Tel: +49 2161 56230
<http://www.cipherlab.de>

Type of Equipment

Mobile Computer

Model(s) Declared

CP60

Initial Year of Manufacture **2013**

Reference to the specification under which conformity is declared in accordance with Directive- 2004/108/EC, 99/5/EC

EN 301 489-1 V1.8.1:2011-09	EN 301 489-3 V1.4.1 2002-08
EN 301 489-17 V2.2.1: 2012-09	EN 300 328 V1.7.1:2006
EN 301 893 V1.6.1:2011	EN 300 440-1 V1.6.1:2010
EN 300 440-2 V1.4.1:2010	EN 55022:2010
EN 55024:2010	EN 61000-3-2:2006
EN 61000-3-3:2008	

The manufacturer also declares the conformity of above mentioned product with the actual required safety standards in accordance with Directive 2006/95/EC

EN 60950-1:2006+A11:2009+A1:2010+A12:2011
Safety for information technology equipment including electrical business equipment

I the undersigned, hereby declare that the equipment specified above conforms to the above Directive(s) and Standard(s).

Manufactory Representative:

Signature

Full Name Kan Chen
Title Engineer



Declaration of Conformity

Manufacturer

CIPHERLAB Co., Ltd.
12F., 333, Dunhua S. Rd., Sec. 2
Taipei, Taiwan 106, R.O.C.

Tel: +886 2 8647 1166
http://www.cipherlab.com

European information

CipherLab GmbH
Willicher Damm 145
41066 Mönchengladbach
Germany

Tel: +49 2161 56230
http://www.cipherlab.de

Type of Equipment

Mobile Computer

Model(s) Declared

CP60G

Initial Year of Manufacture **2013**

Reference to the specification under which conformity is declared in accordance with Directive- 2004/108/EC, 99/5/EC

EN 301 489-1 V1.8.1:2011-09
EN 301 489-7 V1.3.1:2005-11
EN 301 489-24 V1.5.1:2010-10
EN 301 893 V1.6.1:2011
EN 300 440-2 V1.4.1:2010
EN 301 908-1 V4.2.1:2010
EN 55022:2010
EN 61000-3-2:2006
EN 62311:2008

EN 301 489-3 V1.4.1 2002-08
EN 301 489-17 V2.2.1: 2012-09
EN 300 328 V1.7.1:2006
EN 300 440-1 V1.6.1:2010
EN 301 908-2 V5.2.1
EN 301 511 V9.0.2:2003
EN 55024:2010
EN 61000-3-3:2008

The manufacturer also declares the conformity of above mentioned product with the actual required safety standards in accordance with Directive 2006/95/EC

EN 60950-1:2006+A11:2009+A1:2010+A12:2011

Safety for information technology equipment including electrical business equipment

I the undersigned, hereby declare that the equipment specified above conforms to the above Directive(s) and Standard(s).

Manufactory Representative:

Signature 

Full Name Kan Chen
Title Engineer

RELEASE NOTES

Version	Date	Notes
1.01	Aug 16, 2013	<ul style="list-style-type: none">▶ Update Safety Notice▶ Add IP67▶ Update accessories▶ Replace QWERTY keypad picture▶ Update screen resolution: delete QVGA▶ Update drop specification▶ Revise SE4500 to SE4500DL▶ Revise description for 1.3. Scanning good read LED, speaker and vibrator▶ Supports entering invisible characters as prefix & suffix of decoded data under 2.1.2 General Settings - Data Output▶ Add Reader Config Notification Settings under 2.1.2 General Settings▶ Add Picklist Mode under 2.1.4 Reader Config settings page (2D imager)▶ Revise 1.6.2 Screen Rotation & 1.6.3 Backlight Setting UI▶ Add warning message for Camera/2D Reader in Chapter 3▶ Revise 5.2 Use Wi-Fi UI and settings▶ Revise 7.3 Signature Utility icon▶ Add 7.4 Push to Talk▶ Add note for RTC time retention in 8.2 System▶ Add 8.2.3 System Folder - USB Connection▶ Add "Data only" in WWAN specifications▶ Update IEC specs for tumbling test and ESD description▶ Add SE965HP in Appendix I & II▶ Add Transmit Check Digit under Appendix II EAN-13 barcode settings
1.00	Feb 08, 2013	Initial release

CONTENTS

PREFACE	- 2 -
Copyright.....	- 2 -
Disclaimer.....	- 2 -
Trademark Recognition	- 2 -
Contact	- 2 -
For United States	- 3 -
Safety Notices.....	- 3 -
Radio wave exposure and Specific Absorption Rate (SAR) information	- 3 -
For United States.....	- 4 -
For Product with Laser	- 4 -
Safety Precautions.....	- 5 -
Care & Maintenance.....	- 5 -
Declaration of Conformity	- 6 -
RELEASE NOTES	- 8 -
INTRODUCTION	1
About This Document	1
Features.....	2
Inside This Package.....	2
Accessories	2
USE MOBILE COMPUTER	3
1.1. Take a Tour	4
1.1.1. Overview	4
1.1.2. Inside Battery Chamber	5
1.1.3. Before Initial Use	5
1.2. Power on	6
1.2.1. Power Menu	6
1.3. Notifications	8
1.4. Battery.....	9
1.4.1. Main Battery Setup	10
1.4.2. Charge Batteries	13
1.4.3. Monitor Battery Level	16
1.4.4. Power Management	20
1.4.5. Optimize Battery Life	20
1.5. Keypad.....	21
1.5.1. Physical keypad	21
1.5.2. Onscreen Keyboard	30
1.5.3. Handwriting Recognition.....	35
1.5.4. Edit Text	38
1.6. Touch Control	39
1.6.1. Use Touchscreen	39
1.6.2. Screen Orientation.....	39
1.6.3. Adjust Backlight	41

1.6.4.	Calibration	43
1.7.	Memory	44
1.7.1.	Data Loss Caution	44
1.7.2.	Check Storage	44
1.7.3.	Insert SD Card	46
1.8.	Direct Data Communication	47
1.8.1.	Use Cable.....	47
1.8.2.	Use Cradle.....	48
1.8.3.	Syncing Tools	49
1.8.4.	Sync Partnership	49
1.8.5.	1 st USB Sync	50
1.8.6.	Disconnect USB ActiveSync.....	52
1.8.7.	ActiveSync Actions to Take.....	53
1.9.	Audio Playback	59
1.9.1.	Volume Control.....	59
DATA CAPTURE	61	
2.1.	Configure Reader	62
2.1.1.	Launch Reader Config	62
2.1.2.	General Settings.....	63
2.1.3.	Symbology.....	69
2.1.4.	Miscellaneous	72
2.1.5.	Reader Config Option Menu	73
2.2.	Launch Reader Demo	78
2.3.	Read Printed Barcodes	79
CAMERA	81	
3.1.	Launch Camera.....	82
3.1.1.	Camera Screen	82
3.2.	Take Pictures	83
3.2.1.	Camera Settings	84
3.3.	Launch Video Camera	86
3.3.1.	Video Camera Screen.....	86
3.4.	Shoot Videos	87
3.4.1.	Video Camera Settings	88
3.5.	Pictures & Videos	89
OPERATING SYSTEM.....	91	
4.1.	1 st Startup	92
4.1.1.	Exit CipherLab Smart Shell	93
4.2.	Today Screen	95
4.2.1.	Customize Today Screen.....	96
4.2.2.	Return to Today Screen.....	96
4.3.	Start Screen.....	97
4.3.1.	Return to Start Screen	98
4.3.2.	Title Bar	98
4.3.3.	Manage Notofications	100
4.3.4.	Customize Start Screen	102
4.3.5.	Start Screen Icons.....	105

4.4.	Suspend & Reset Mobile Computer	107
4.4.1.	Suspend Mobile Computer	107
4.4.2.	Wake Up Mobile Computer	108
4.4.3.	Reset Mobile Computer	109
4.5.	Set Screen Lock	110
4.5.1.	Unlock Screen	110
4.6.	Work With Menus.....	111
4.6.1.	Option Menus	111
4.6.2.	Context Menus.....	112
4.7.	Manage Applications.....	113
4.7.1.	Task Manager	113
RADIOS		119
5.1.	Access Cellular WAN.....	120
5.1.1.	Status Icons	120
5.1.2.	Check Network in Use	121
5.1.3.	Enable/Disable Mobile Data	121
5.1.4.	Use Only 2G Networks.....	122
5.1.5.	Cellular Data Setup	122
5.1.6.	Edit & Add Access Points	124
5.1.7.	USB Internet Sharing	125
5.2.	Use Wi-Fi	126
5.2.1.	Launch SCU	126
5.2.2.	Status Tabbed Page.....	127
5.2.3.	Configuration Tabbed Page.....	128
5.2.4.	Diagnostics Tabbed Page	143
5.3.	Use Bluetooth.....	150
5.3.1.	Status Icons	150
5.3.2.	Change Bluetooth Name.....	150
5.3.3.	Turn On/Off Bluetooth.....	151
5.3.4.	Expose Mobile Computer.....	151
5.3.5.	Pair & Connect Bluetooth Devices	153
5.3.6.	Disconnect Bluetooth Devices.....	155
5.3.7.	Unpair Bluetooth Devices.....	156
5.3.8.	Reconnect Bluetooth Devices	156
5.3.9.	Edit Bluetooth Features to Use	156
5.3.10.	Bluetooth File Exchange	158
5.3.11.	Bluetooth ActiveSync	159
5.3.12.	Bluetooth Internet Sharing	161
5.3.13.	Bluetooth Pass-through Networking.....	162
5.4.	Connect to Virtual Private Network.....	163
5.4.1.	VPN Connection Setup	163
5.4.2.	Connect To VPN	165
5.4.3.	Edit VPN	166
5.4.4.	Delete VPN	166
5.5.	Install Secure Certificates	167
5.5.1.	Supported Certificate Formats	167
5.5.2.	View Secure Certificates.....	167
5.5.3.	Install Secure Certificates	167
5.6.	Location Discovery	169

5.6.1.	Launch GPS.....	169
5.6.2.	Use GPS.....	170
5.6.3.	Use External GPS Receiver With Bluetooth	170
PHONE		179
6.1.	About Phone	180
6.2.	SIM Card	180
6.2.1.	Install SIM Card.....	180
6.3.	Status Icons	181
MORE APPLICATIONS		183
7.1.	Button Assignment	184
7.1.1.	Launch Button Assignment	184
7.1.2.	Redefine Keys	185
7.1.3.	Main Menu.....	187
7.1.4.	Keypad Modes	191
7.2.	GPS Viewer	195
7.2.1.	Launch GPS Viewer	195
7.2.2.	View NMEA-based Data.....	197
7.3.	Signature Utility.....	198
7.3.1.	Launch Signature Utility	198
7.3.2.	Capture Signature.....	199
7.3.3.	View or Edit Existing Signatures	200
7.3.4.	Preferences	201
7.4.	Push to Talk.....	202
7.4.1.	Launch Push to Talk	202
7.4.2.	Communicate With Group Members	203
MANAGE MOBILE COMPUTER		209
8.1.	Update OS Image.....	210
8.1.1.	USB Update	210
8.2.	System Settings.....	212
8.2.1.	Connections Folder	214
8.2.2.	Personal Folder.....	218
8.2.3.	System Folder	219
SPECIFICATIONS.....		229
Platform, Processor & Memory		229
Communications & Data Capture		229
Electrical Characteristics.....		230
Physical Characteristics		231
Environmental Characteristics.....		232
Programming Support		232
Accessories		233
SCAN ENGINE SETTINGS		235
Symbologies Supported		236
LASER (SE955 & SE965HP).....		239
Symbology Settings.....		239
Miscellaneous		245

AIM Code ID - Code Characters.....	245
AIM Code ID - Modifier Characters.....	246
2D IMAGER (SE4500DL).....	249
Symbology Settings.....	249
1D Symbologies.....	249
2D Symbologies.....	256
Miscellaneous.....	257
PHYSICAL KEYPAD REFERENCE TABLE.....	259
Numeric Keypad.....	259
Using Alpha, Shift & Fn Keys.....	259
QWERTY Keypad.....	261
Using Alpha, Shift & Fn Keys.....	261

INTRODUCTION

Thank you for choosing CipherLab products. CipherLab welcomes another Windows Embedded by introducing CP60 Series Mobile Computer. Powered by Windows Embedded Handheld 6.5, the mobile computer delivers better user experience and promises enterprise mobile computing.

The mobile computer has transfective LCD to hold up the readability in a wide range of light conditions, courtesy of the supplementary backlight enabled by a built-in ambient light sensor. Also on board is a G-sensor to save power according to the mobile computer's motion and posture. G-sensor also enables screen orientation when the device is posed sideways or upright. Furthermore, the mobile computer has integrated a built-in e-compass and gyroscope, both of which provide useful functions in navigation.

The series sports satisfactory data connections by integrating a communication port for direct data exchange. For wireless data connections it hosts each Bluetooth and 802.11b/g module while a HSPA+ (3.8G) module is provided on option.

Dedicated to data capture, the mobile computer has essential 1D (laser) reader or 2D imager. A high-specced 5 mega-pixel camera also comes inside to take pictures and shoot videos to deliver better documentation for users.

Rated with IP65/67, the rugged CP60 is light-weighted and easy to cradle in your hand, and will be your good help on field works.

ABOUT THIS DOCUMENT

This guide distills the information about CP60 Series Mobile Computer. Subjects discussed include the mobile computer's physical features, platform basics, software and applications, and part of the accessories to boost the mobile computer's performance.

We recommend that you keep one copy of this manual at hand for the quick reference for necessary maintenance.

FEATURES

- ▶ Rugged yet smoothened outlined, with hand strap for secure hold
- ▶ IP65/67-rated tough form to survive drop, shock, heat, cold, and impervious to moisture/dust
- ▶ Windows Embedded Handheld 6.5 OS, TI DM3730 1GHz CPU
- ▶ 512MB SDRAM to run application programs
- ▶ 4GB NAND flash to store OS, applications, settings and so on
- ▶ Storage expansion: Up to 32GB MicroSDHC
- ▶ Sunlight-readable screen to enhance the viewability of outdoor use
- ▶ Ambient light sensor to enable supplementary backlight for LCD and keypad
- ▶ G-sensor for power management and screen orientation
- ▶ Gyroscope sensor and E-compass for direction and location sensing
- ▶ 2 symmetric side-triggers for ambidextrous scanning
- ▶ Total data solution — supporting Bluetooth, 802.11a/b/g/n and HSPA+
- ▶ Built-in GPS receiver to deliver location discovery information
- ▶ 5 mega-pixel camera for taking pictures and shooting videos
- ▶ C++ and .Net programming support

INSIDE THIS PACKAGE

The mobile computer ships with the following items. Save the box and packaging material in case of future need to store or deliver the mobile computer.

- ▶ Mobile Computer
- ▶ Rechargeable Li-ion battery pack (standard/high capacity)
- ▶ Stylus
- ▶ Screen protector
- ▶ Hand strap
- ▶ Product CD
- ▶ Quick Start Guide

ACCESSORIES

Optional accessories to enhance the mobile computer's performance are:

- ▶ Snap-on Charging and Communication Cable (USB or RS-232)
- ▶ Charging & Communication Cradle
- ▶ Pistol Grip
- ▶ Belt Holster for CP60 with Pistol Grip
- ▶ Belt Holster with Shoulder Strap for CP60 without Pistol Grip
- ▶ 4-slot Battery Charger
- ▶ Snap-On Car Charging Kit (coming soon)
- ▶ Vehicle Mount Cradle (coming soon)
- ▶ 4-slot Terminal Cradle (coming soon)

Chapter 1

USE MOBILE COMPUTER

Before the mobile computer takes part in your work, get to know it first. This chapter includes the basic features of the mobile computer including the power supply, memory, and the units that bridge users with the mobile computer. This chapter helps you set the mobile computer to work at the earliest.

1. IN THIS CHAPTER

1.1 Take a Tour	4
1.2 Power on	6
1.3 Notifications	8
1.4 Battery.....	8
1.5 Keypad.....	21
1.6 Touch Control.....	39
1.7 Memory.....	44
1.8 Direct Data Communication	47
1.9 Audio Playback	59

1.1. TAKE A TOUR

This section shows the major components on the mobile computer and inside battery chamber. You will also learn how to power on/off the mobile computer and how the mobile computer gives information about its status.

1.1.1. OVERVIEW

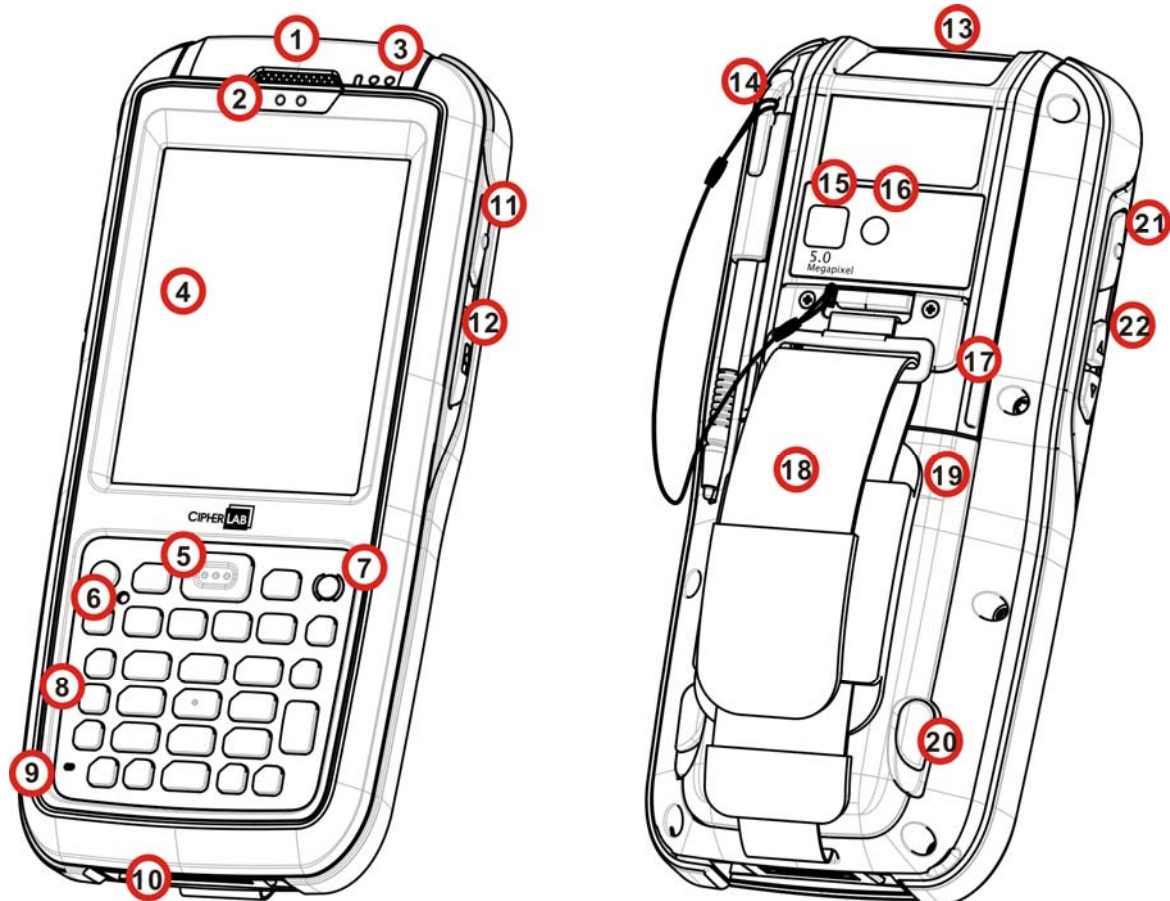

Figure 1: Overview

No.	Description	No.	Description
1	Receiver (reserved)	2	Sensors (proximity sensor & light sensor)
3	Status LEDs	4	Touchscreen
5	Scan key	6	Reset button (recessed in keypad)
7	Power button	8	Keypad
9	Microphone (reserved)	10	Charging and communication port
11	Side trigger (user-definable)	12	Application key
13	Scan window	14	Stylus (with attaching cord)
15	Camera	16	Camera flash
17	Speaker	18	Handstrap
19	Battery door	20	Battery door latch
21	Side trigger (user-definable)	22	Volume rocker

1.1.2. INSIDE BATTERY CHAMBER

Inside the battery chamber of the mobile computer are the sockets for SIM card and storage card. Each is equipped with a hinged cover.

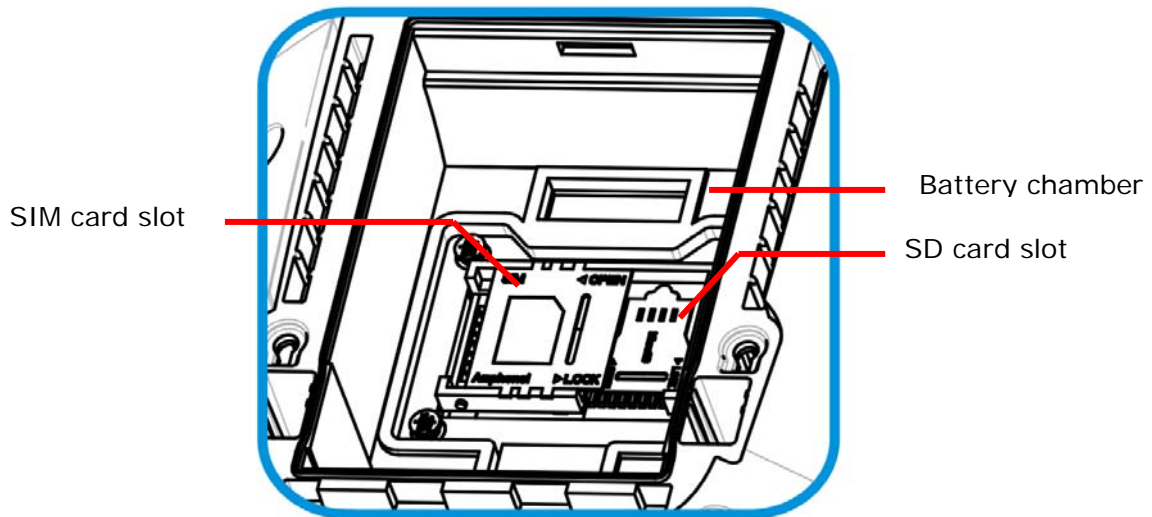

Figure 2: Inside Battery Chamber

1.1.3. BEFORE INITIAL USE

Prior to using the mobile computer for the first time, it is recommended to apply the protective film over the LCD. This will prevent scratching the touchscreen during daily usage, and also help enhance the durability of the touchscreen.

To apply the LCD protective film:

- 1) Upon delivery, the touchscreen of the mobile computer is covered with a thin transparent film. Peel off and discard this film.
- 2) Wipe the touchscreen with a clean, non-abrasive, lint-free cloth.
- 3) Carefully apply the LCD protective film to the touchscreen by aligning its edges with the edges of the touchscreen. Make sure the film adheres tightly to the surface.

The mobile computer is then ready for usage.

1.2. POWER ON

To power on the mobile computer, press the Power button  sitting at the upper right of the keypad. The mobile computer powers on.

1.2.1. POWER MENU

The CP60 mobile computer features a power menu. This menu allows you to select whether you would like to power off the mobile computer, enter suspension, or enter sleeping mode for main battery replacement.

To enter this power menu, press the power button for more than three seconds. A menu will open onscreen with a countdown bar at the bottom.

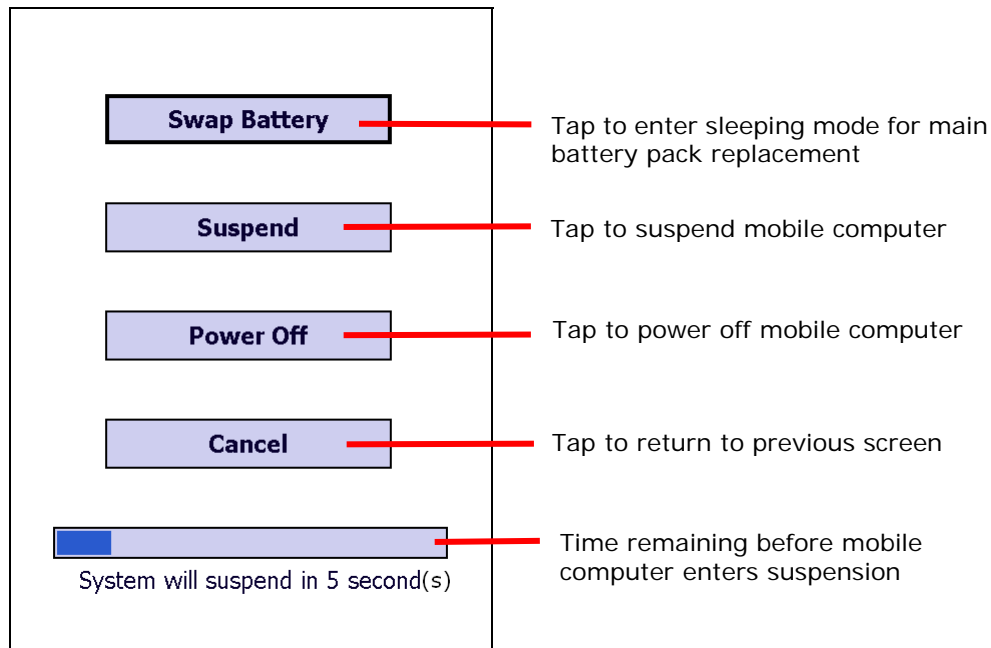

Menu options are as follows:

Action to take	Description
Swap Battery	<p>If you would like to replace the main battery pack on the mobile computer, select this option to let the mobile computer enter sleeping mode.</p> <p>After the main battery has been replaced, wake up the mobile computer by pressing the power button. All applications and tasks will remain active.</p>
Suspend (default)	<p>When the mobile computer is not under frequent use, select this option to let the mobile computer enter suspension and save power. This is the default function, and when no option is selected in the power menu, the mobile computer will automatically enter suspension after 5 seconds.</p> <p>When you need to use the mobile computer once more, resume it by pressing the power button. All applications and tasks will remain active.</p> <p>See also Suspend & Reset Mobile Computer.</p>

Power Off	Select this option if you would like to power off the mobile computer. This will close all applications and tasks currently running. All unsaved data will be lost. To power on the mobile computer, press the power button.
Cancel	Selecting this option will close the menu and return to the previously active screen. All applications and tasks will remain active.

Note: If you wish to replace the main battery pack on the mobile computer, please make sure the following requirements are met. Otherwise, the mobile computer might need to be powered on again after the battery is put into place.

- (1) Make sure the backup battery on the mobile computer is not drained out. Check [Backup Battery Level](#) before taking any actions.
 - (2) After selecting **Swap Battery** in the power menu, proceed to replacing the battery as soon as possible.
-

1.3. NOTIFICATIONS

The mobile computer features visible, audible, and tactile feedback to draw users' prompt awareness of the mobile computer's contiguous events such as barcode reading, wireless/mobile data connections, and battery charging.

STATUS LED

Three LED lights are located on the upper-right corner of the mobile computer. Their functions are:

Matter	LED Color	Action	Description
Scanning Good Read (Left)	Green	Green, flashes once	Indicates good reading of the scanned barcode. Enable/Disable this LED light on the Reader Config Notification Settings page. To set the good read LED via API deployment, see the CP60 Programming Guide for details.
Radios (Middle)	Blue	Blinking	Wi-Fi, Bluetooth or mobile data in use.
Battery Charging (Right)	Green, Orange, Red	Green, solid	Battery is nearly fully charged (battery level > 95%).
		Orange, solid	Battery is charging, and battery level is sufficient for the mobile computer to power on.
		Red, solid	Battery is charging, but battery level is too low for the mobile computer to power on.
		Red, fast blinking continuously	Charging error that may be caused by temperature dropping below 0°C or exceeding 35°C. See also Charge Batteries .

SPEAKER

The mobile computer has a speaker on the back for audio signaling and playback.

The speaker sounds for system events, application warnings, onscreen item selection and physical keypad stroke. In noisy environments, the speaker remains efficacious with the help of a headset. To control sound volume, see [Volume Control](#).

The speaker also sounds for successful barcode reading, which can be controlled on the Reader Config [Notification Settings](#) page. Speaker good read sound is also programmable through API deployment. For details, see the CP60 Programming Guide.

VIBRATOR

The mobile computer owes its tactile feedback to the vibrator built inside. Vibration delivered to the mobile computer alerts users of its current status.

Working based on user's sense, the vibrator is particularly helpful when the mobile computer is serving in a noisy environment.

Same as the speaker and LED light, the vibrator also works for good barcode reading. Enable/disable vibration and set its duration on the Reader Config [Notification Settings](#) page. Alternatively, program the vibrator through API deployment to have it vibrate when a successful reading occurs. For details, see the CP60 Programming Guide.

1.4. BATTERY

The mobile computer is fed by two batteries, main battery pack and backup battery. The main battery is removable and replaceable from the battery chamber while the backup battery is mounted on the main board inside the mobile computer.

When the mobile computer is shipped, the main battery is stored in a package separated from the mobile computer, which keeps it in good condition for future use.

MAIN BATTERY

The main battery is a Li-ion battery pack that comes in two sizes, a standard 3.7V/3600mAh pack and a high capacity 3.7V/4400mAh pack. The standard battery will take around 4 hours to charge to full, while the high capacity battery pack will require approximately 6 hours charging to reach full battery level. The working time of the mobile computer varies by its working states. See [Operating Time](#) for details on how long the mobile computer will operate under different conditions.

An icon on [Title Bar](#) helps monitor the main battery level. See [Main Battery Level](#).

See also [Main Battery Setup](#) for the assembly.

BACKUP BATTERY

The backup battery is settled on the main board inside the mobile computer. It is a 15 mAh rechargeable Li-ion battery. When main battery is absent or depleted, backup battery takes over to feed the mobile computer. Without main battery, a fully charged backup battery retains the data in the DRAM and holds the system in suspension for 30 minutes (as long as wireless modules are inactive).

The backup battery is rechargeable by the external power (through power adapter) or main battery pack. It takes about 5 hours to charge it to full. An  icon on the [Title Bar](#) makes it observant that backup battery gets low. See also [Backup Battery Level](#).

Note: When removing the main battery pack, actual data retention time will depend on the backup battery level. Check backup battery level before replacing the main battery to ensure your data is retained.

1.4.1. MAIN BATTERY SETUP

To secure main battery in place, the battery door is equipped with two latches, one on each side. After pressing the battery door in, turn the door latches inwards to lock the battery door in place.

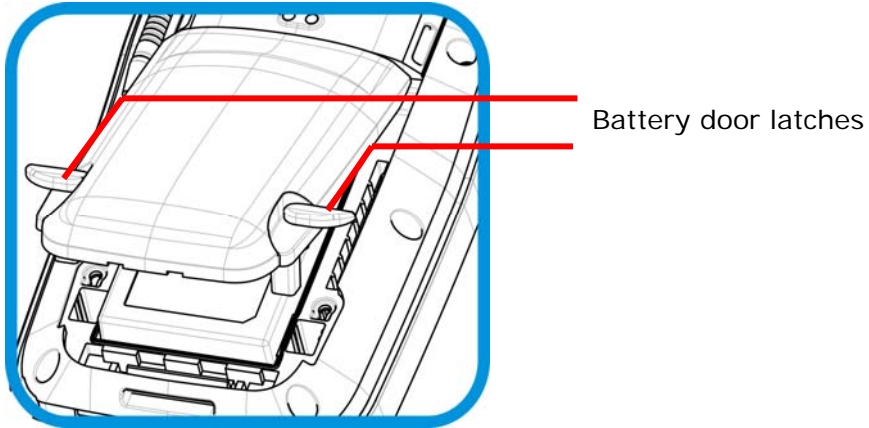

Figure 3: Battery Door Latches

To install main battery pack, follow through the steps below by referencing to the illustrations:

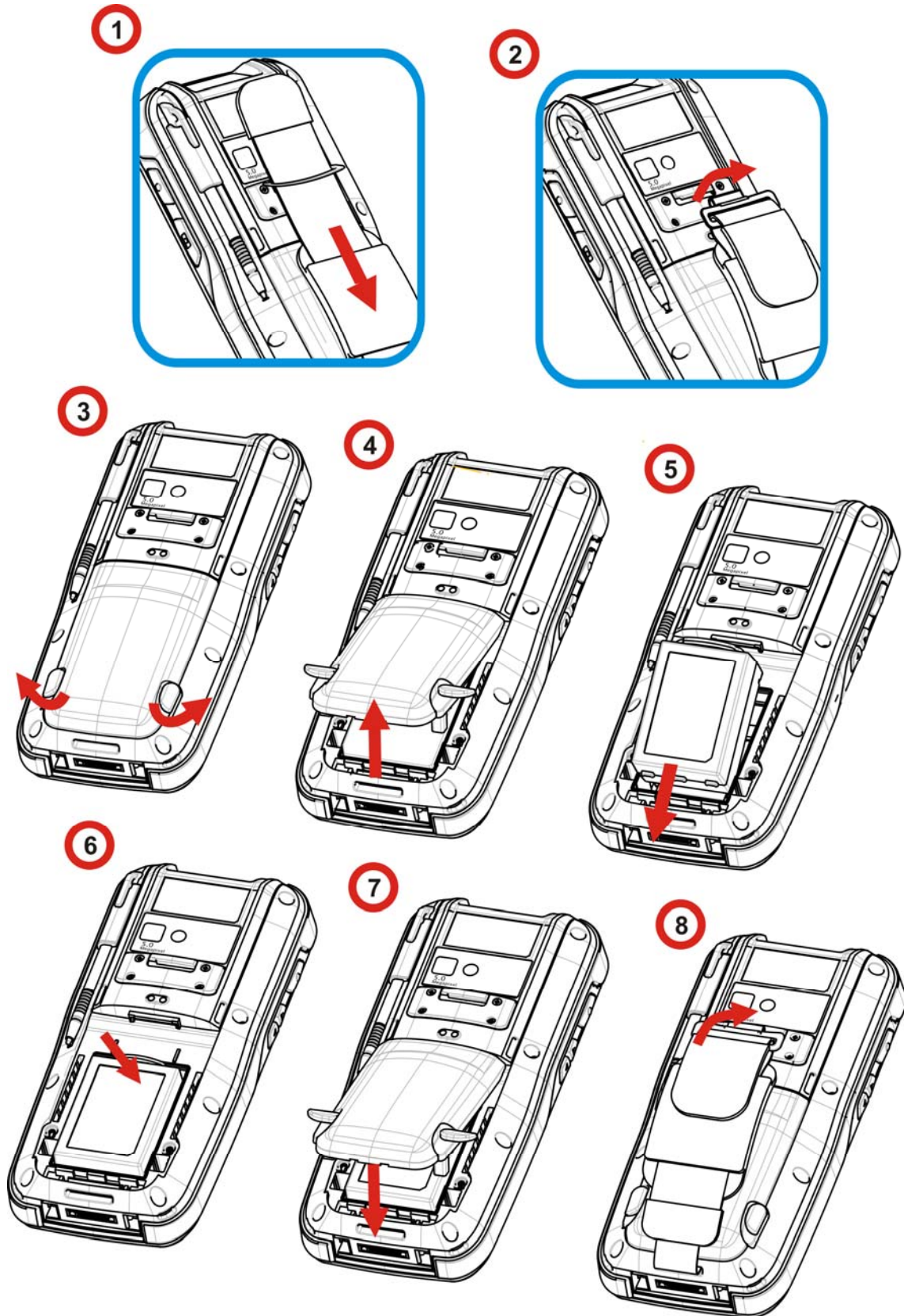

Figure 4: Main Battery Setup

- 1) Loosen the handstrap and pull it downwards so the metal hook is positioned at the lower edge of the Velcro band
- 2) Unhook the hand strap by pressing the square metal ring lightly in the middle and lifting it upwards in a single motion.

Note: The lower end of the handstrap can be left as is without detaching. After the main battery is installed, the handstrap can be hooked back into place.

- 3) On the outer sides of the battery door are two door latches. Pull them outwards to unlock battery door.
- 4) Lift up the lower end of the battery door to remove it.
- 5) Position the main battery pack into the battery chamber with the contact pins facing down. Fix the bottom edge first.
- 6) Press the upper end of the main battery inwards until the clip at the top "clicks" into place.
- 7) Replace the battery door. Fix the upper edge first and then press the lower edge in. Push the door latches back to their original position.
- 8) Secure the handstrap hook back into its groove.

Note: (1) When main battery level drops to low level, charge it ASAP or replace it with a charged one.
(2) Always press the power key and select **Swap Battery** in the power menu before replacing the main battery pack.
(3) The battery door must be secured in place for the mobile computer to operate.
(4) Any improper handling may reduce battery life.

1.4.2. CHARGE BATTERIES

Due to shipment, it is likely that the main battery and backup battery won't be fully charged when you receive the package. Before setting the mobile computer to work, charge the main battery to full by direct charging via a power adapter (with the help of a Snap-on Charging & Communication Cable or Charging & Communication Cradle).

Since the main battery is the only source backup battery taps power from, be sure to install main battery for the 1st charge so both main battery and backup battery get charged.

Some key facts about charging batteries:

Charging Time

- ▶ **Main battery:** It takes circa 4 hours to charge standard size main battery, and 6 hours to charge high capacity battery to full (via direct charging with power adapter). The battery charging LED above the touchscreen (the one to the right) lights red or orange during charging (depending on the battery level at the moment), and lights green when mobile computer is near 100% charged.
- ▶ **Backup battery:** The backup battery is rechargeable by both main battery and power adapter. It takes about 5 hours to charge it to full, however it does not need to be fully charged for the mobile computer to work.

Charging Temperature

- ▶ It is recommended that batteries be charged at room temperature (18°C~25°C) for optimal performance.
- ▶ Charging stops when temperature drops below 0°C or exceeds 35°C. In this case the battery charging LED will be continuously blinking in red.

Power Consumption

- ▶ When all radios (802.11 a/b/g/n, Bluetooth, mobile data (HSPA+), GPS) are active on battery power, main battery level drops substantially.
- ▶ In order to prevent the system from shutting down due to depleted main battery, we suggest that you keep a fully charged battery for replacement or have the mobile computer access the radios on external power.

The following guides how to charge batteries.

DIRECT CHARGING USING SNAP-ON CABLE

Direct charging of the mobile computer relies on the Snap-on Charging & Communication Cable (hereinafter "snap-on cable"). There is a power jack on the connector of this cable to connect external power.

Prior to charging, install main battery as described in [Main Battery Setup](#). Then follow the steps below:

- 1) Attach the snap-on cable to the mobile computer.
- 2) Plug the head of the power adapter cord into the power jack located on snap-on cable's connector.
- 3) Connect the power adapter to a power outlet.

To output data to your PC or laptop, connect the snap-on cable (either through USB or RS-232 connection) to it. See [Direct Data Communication](#) for follow-ups.

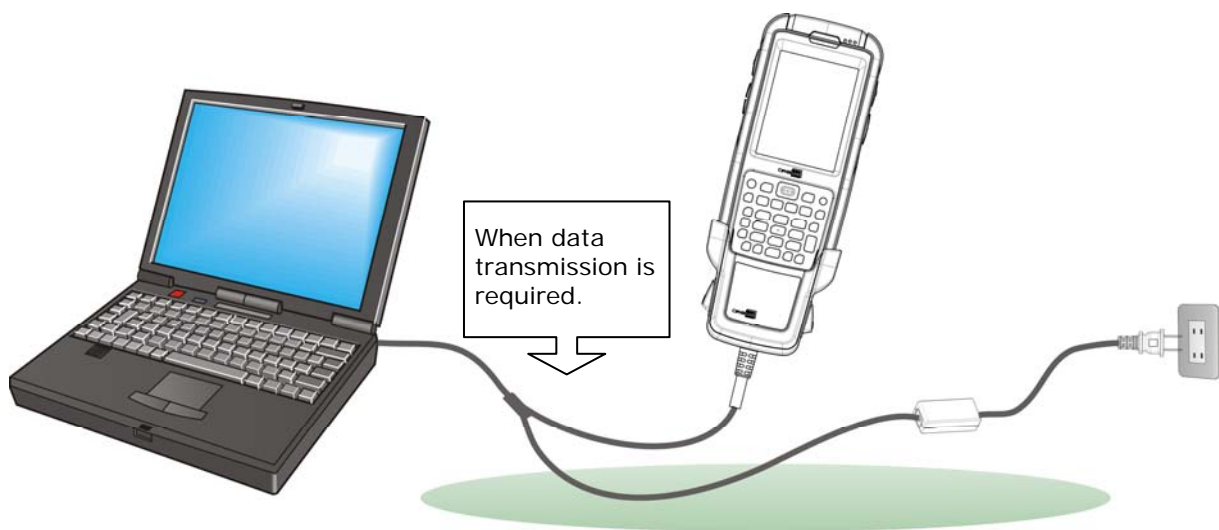

Figure 5: Direct Charging Using Snap-on Cable

DIRECT CHARGING USING CRADLE

Direct cradle charging makes use of a Charging & Communication Cradle (hereinafter “cradle”). The cradle is one of the accessories you can opt for.

Prior to charging, install main battery as described in [Main Battery Setup](#). Then follow the steps below:

- 1) Seat the mobile computer into the cradle.
- 2) Connect the cradle to an external power source using the power adapter.

To output data to your PC or laptop, connect the mobile computer and your PC with a microUSB cable. See [Direct Data Communication](#) for follow-ups.



Figure 6: Direct Charging Using Cradle

REPLACE MAIN BATTERY PACK

The Cradle holds a separate charging compartment for the main battery pack. This allows the mobile computer and a separate main battery pack to be charged either individually or simultaneously. We advise you to keep a fully charged battery at hand at all times using the Cradle.

If the main battery level is running low and you decide to replace it with a fully charged one, follow the procedure denoted in [Power Menu](#) to swap batteries.

Note: If the process for swapping batteries is not followed, you might need to power on the mobile computer after inserting the main battery. In this case, all unsaved data will be lost.

1.4.3. MONITOR BATTERY LEVEL

Main battery is the only source that feeds the mobile computer to work. It also supplies the backup battery on main board to retain the data stored in DRAM. Hence when main battery level gets low, recharge it or change it as soon as possible. But foremost, back up the important data from time to time to protect your work.

MAIN BATTERY LEVEL

The OS features a few icons for user's immediate awareness of main battery level. These icons appear on the [Title Bar](#), which is settled at the top of almost every screen.

STATUS ICONS

Main battery icons communicate the following statuses:

Icon	Battery Status
	Main battery is being charged from external power.
	Main battery level is 80% to full.
	Main battery level is partially drained between 60%-79%.
	Main battery level is between 40%-59%.
	Main battery level is between 20%-39%.
	Main battery has dropped between 1%-19% Battery needs charging immediately.

MORE CHARGING INFO

To know more about main battery level:

- 1) Tap Windows icon  on the softkey bar.
Start screen opens.

- 2) Tap **Settings** | **System** | **Power Information** .

Power Information application opens showing **Battery** tabbed page. The page shows a horizontal bar to enable quick grasp of battery level at a glance. Battery level percentage is also shown under the horizontal bar.

When the main battery is not being charged, battery percentage will be shown as remaining battery power. When the main battery is being charged, the page indicates that the battery is "under charging", with battery percentage available as well.

Main battery isn't being charged.

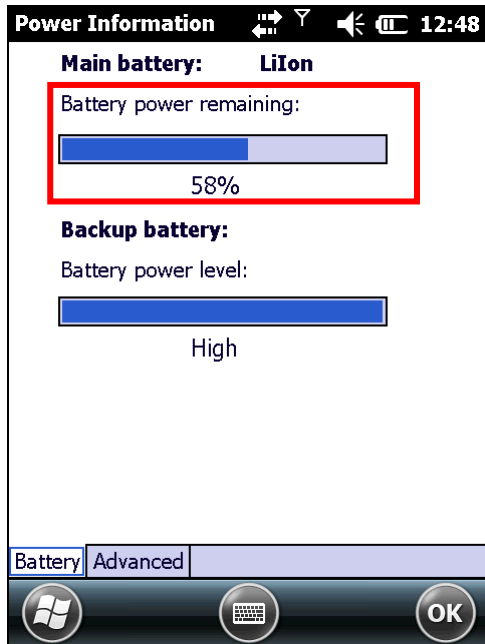

Main battery is being charged.

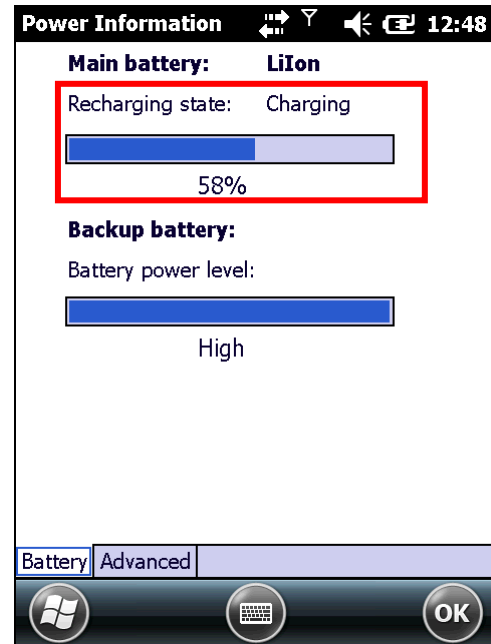

LOW BATTERY ALERTS

When main battery level drops below 40% , the mobile computer prompts "Main Battery Low" for a recharge. When further reduced to under 20%, the mobile computer prompts "Main Battery Very low" to solicit your immediate transaction.

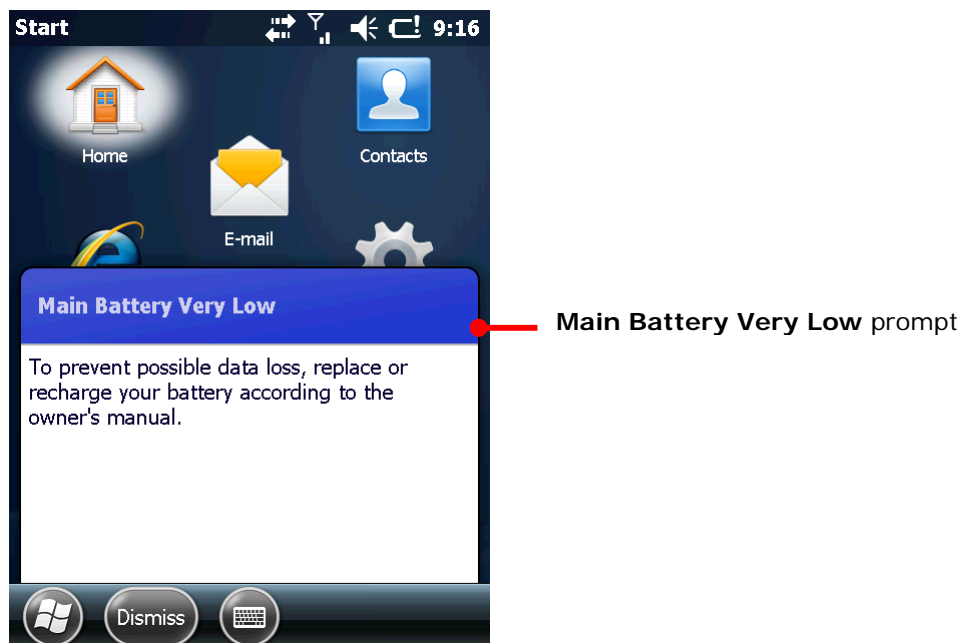

Low battery may incur shutdown to the mobile computer and cause DRAM data damage. Always save data before running short of power or keep a fully charged battery at hand for replacement.

Note: Constant usage of the mobile computer at low battery level can affect battery life. For maximum performance, recharge the battery periodically to avoid battery drain out and maintain good battery health.

When main battery drains out, the mobile computer shuts down automatically. Backup battery takes over to hold DRAM data for 30 minutes if it is fully charged. When this occurs, replace main battery pack immediately.

BACKUP BATTERY LEVEL

For user's immediate awareness of backup battery level, OS shows an  icon on [Title Bar](#) when battery level drops low.

STATUS ICONS

Backup battery icon delivers the following statuses:

Icon	Battery Status
	Battery level has dropped low and needs charging.

MORE CHARGING INFO

To learn more about backup battery level:

- 1) Tap Windows icon  on the softkey bar.
Start screen opens.
- 2) Tap **Settings** | **System** | **Power Information**.

Power Information application opens showing **Battery** tabbed page. Backup battery level displays in a horizontal bar beneath Main battery level, and is also summarized in text.

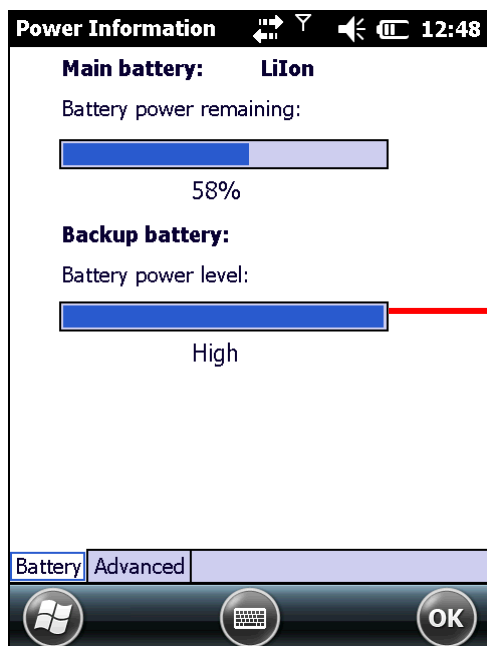

Backup battery level is displayed in a horizontal bar with a summarized description below

Available backup battery level descriptions are:

Description	Battery Status
High	Backup battery level is full
Low	Backup battery level is low. Charging is recommended.
Critical	Backup battery level is very low and needs to be charged immediately.
Unknown	Backup battery level is unknown.

LOW BATTERY ALERT

When backup battery drops low, the mobile computer prompts for recharge with a dialog. And [Title Bar](#) shows an  icon.

Backup battery is rechargeable by external power (through power adapter) or main battery pack.

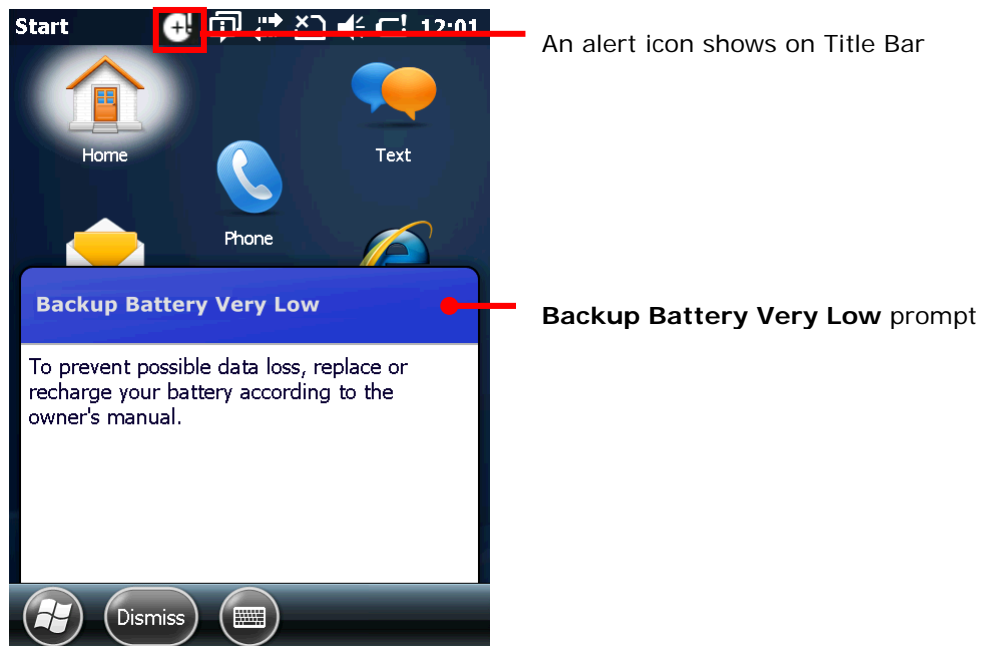

Low backup battery puts DRAM data in great danger. Always save data from time to time or keep a fully charged battery at hand for replacement.

Once backup battery drains out completely, the data in DRAM is gone. Any data yet to be saved is lost!

1.4.4. POWER MANAGEMENT

The mobile computer features “suspension”, a “soft-off” state allowing the mobile computer to consume less power and quickly to wake up.

The mobile computer auto-enters “suspension” when one of the following happens:

- ▶ When placed face-down, which suggests the mobile computer isn’t actively used.
- ▶ When battery door isn’t in place.

It wakes up when following events occur:

- ▶ Power button or scan key is pressed
- ▶ WWAN wake-on-ring signal occurs
- ▶ USB cable is plugged-in
- ▶ AC is plugged in

Note the mobile computer is also manually suspendible through Power button. See [Suspend Mobile Computer](#).

1.4.5. OPTIMIZE BATTERY LIFE

Power issues are critical for portable devices. Always turn off the features you don’t need on the mobile computer in order to save power. To extend battery life as long as possible, always take the following actions:

- ▶ Suspend the mobile computer when it isn’t actively used. (See [Suspend Mobile Computer](#))
- ▶ Turn down LCD backlight brightness as described in [Adjust Backlight](#), and set a shorter LCD timeout as described in [Suspend & Reset Mobile Computer](#)
- ▶ Auto Sync the mobile computer with your PC less frequently. See [Direct Data Communication](#).
- ▶ If you are using any “push e-mail” or any automatic syncing service on the mobile computer, change the syncing schedule to manually check updates.
- ▶ When Wi-Fi, Bluetooth, mobile data (HSPA+), or GPS isn’t used, turn it off. See [Radios](#).

1.5. KEYPAD

The mobile computer has a physical keypad and a touchscreen to receive user's input. Among the two, the touchscreen provides more intuitiveness than the physical keypad to interact with the device.

This section shows how to input text using physical keypad and onscreen keyboard. To know how to touch-control the mobile computer, see [Touch Control](#).

1.5.1. PHYSICAL KEYPAD

The physical keypad sitting front the mobile computer is quite an advanced one with much resemblance to laptop or PC keyboards. It supports multi-key operation, which normally requires two keys hit simultaneously, one of which is a modifier key.

The physical keypad is either a numeric type or a QWERTY one. Each wedges a set of "enhanced keys" along the top and a set of character keys at the lower half.

As for entering text, the numeric and QWERTY keypad are equally capable of entering numbers, letters, symbols and punctuations. Both also receive supplementary backlight as the screen does.



Figure 7: Numeric Keypad



Figure 8: QWERTY Keypad





















ENHANCED KEYS











































Enhanced keys are arranged along the top of physical keypad and separated from character keys. Use these "enhanced keys" to launch actions from the mobile computer and OS, cause the active application to work, or switch physical keypad between input modes. Navigation keys are included also to move the caret in a text input field, and to select between applications on the Start screen.



Figure 9: Enhanced Keys

Enhanced keys can be categorized to five groups and are explicated as follows:

Key Group	Description														
ACTION KEYS	<p>“Action keys” are Scan key and Backlight key. They cause the mobile computer to deliver functions as below:</p> <table border="1"> <thead> <tr> <th>Key</th> <th>Press</th> </tr> </thead> <tbody> <tr> <td> Scan Key</td> <td>Reads barcodes</td> </tr> <tr> <td> Backlight Key</td> <td>Turns on/off screen backlight.</td> </tr> </tbody> </table>	Key	Press	 Scan Key	Reads barcodes	 Backlight Key	Turns on/off screen backlight.								
Key	Press														
 Scan Key	Reads barcodes														
 Backlight Key	Turns on/off screen backlight.														
OS KEYS	<p>The following tabulates OS keys and their functions. Some of them are engraved in orange, which means Function key needs to be pressed beforehand in order to function.</p> <table border="1"> <thead> <tr> <th>Key</th> <th>Press</th> </tr> </thead> <tbody> <tr> <td>Windows </td> <td>Opens Start Screen. (Requires Function Key pressed beforehand.)</td> </tr> <tr> <td>OK</td> <td> <ul style="list-style-type: none"> Confirms input in an input field. (Requires Function Key pressed beforehand.) Delivers the same function as the “OK” command on the softkey bar does. (Requires Function Key pressed beforehand.) See Today Screen and Start Screen for more details about Softkey bar. </td> </tr> <tr> <td>Send </td> <td>Key available for function assignment via CipherLab utility Button Assignment.</td> </tr> <tr> <td>End </td> <td>Key available for function assignment via CipherLab utility Button Assignment.</td> </tr> <tr> <td>Esc</td> <td> <ul style="list-style-type: none"> Opens the previous screen worked on. Closes a menu of an application, or an opened dialog. </td> </tr> <tr> <td>Tab </td> <td> <ul style="list-style-type: none"> Navigates among the highlight items in some applications. Enters Tab character, which means it moves the caret to the next tab stop. </td> </tr> </tbody> </table>	Key	Press	Windows 	Opens Start Screen . (Requires Function Key pressed beforehand.)	OK	<ul style="list-style-type: none"> Confirms input in an input field. (Requires Function Key pressed beforehand.) Delivers the same function as the “OK” command on the softkey bar does. (Requires Function Key pressed beforehand.) See Today Screen and Start Screen for more details about Softkey bar .	Send 	Key available for function assignment via CipherLab utility Button Assignment.	End 	Key available for function assignment via CipherLab utility Button Assignment.	Esc	<ul style="list-style-type: none"> Opens the previous screen worked on. Closes a menu of an application, or an opened dialog. 	Tab 	<ul style="list-style-type: none"> Navigates among the highlight items in some applications. Enters Tab character, which means it moves the caret to the next tab stop.
Key	Press														
Windows 	Opens Start Screen . (Requires Function Key pressed beforehand.)														
OK	<ul style="list-style-type: none"> Confirms input in an input field. (Requires Function Key pressed beforehand.) Delivers the same function as the “OK” command on the softkey bar does. (Requires Function Key pressed beforehand.) See Today Screen and Start Screen for more details about Softkey bar .														
Send 	Key available for function assignment via CipherLab utility Button Assignment.														
End 	Key available for function assignment via CipherLab utility Button Assignment.														
Esc	<ul style="list-style-type: none"> Opens the previous screen worked on. Closes a menu of an application, or an opened dialog. 														
Tab 	<ul style="list-style-type: none"> Navigates among the highlight items in some applications. Enters Tab character, which means it moves the caret to the next tab stop. 														
NAVIGATION KEYS	<p>The buttons right below Scan key are the up/down/right/left navigation keys:</p>  <p>They move the caret in an input field. In certain applications, they navigate vertically or horizontally among highlighted items.</p>														
FUNCTION KEY	<p>Function key  applies its action when used in conjunction with other keys. Together they make the OS take actions or produce functions F1 through F12.</p>														

	<p>and more.</p> <p>Function key comes with an LED indicator beside it which behaves as follows:</p> <ul style="list-style-type: none"> ▶ When Fn key is pressed once, the LED indicator lights up in orange, and the function engraved in orange on the keypad is delivered to the next pressed key. The LED goes off once another key is pressed. ▶ When Fn key is pressed twice, the LED indicator stays lit, and the function engraved in orange on the keypad is delivered to all pressed keys. This mode will continue until Fn key is pressed again. <p>In addition to the LED light, the icons   on the Title Bar will display once Function mode is triggered.</p> <table border="1" data-bbox="432 577 1406 757"> <thead> <tr> <th>Mode</th> <th>Description</th> </tr> </thead> <tbody> <tr> <td></td> <td>Function is delivered to the next pressed key.</td> </tr> <tr> <td></td> <td>Function is delivered to all pressed keys.</td> </tr> </tbody> </table> <p>The Fn key is also effective by pressing and holding it and then pressing the desired key.</p> <p>When other text input modes are activated at the moment, pressing the Fn key will alter the input mode and the icon on the Title Bar. See Numeric Keypad and QWERTY Keypad for details on other text input modes.</p>	Mode	Description		Function is delivered to the next pressed key.		Function is delivered to all pressed keys.						
Mode	Description												
	Function is delivered to the next pressed key.												
	Function is delivered to all pressed keys.												
<p>[ALPHA] KEY</p> 	<p>[Alpha] key  changes keypad input mode. When [Alpha] key is pressed once, [alpha] mode is activated temporarily, and the LED indicator next to the physical key lights up in blue accordingly. This mode will end after a single key has been pressed. Upon pressing any key, keypad input mode will resume back to default, and the LED indicator will turn off.</p> <p>When [Alpha] key is pressed twice, [alpha] mode is activated permanently, and the LED indicator next to the physical key stays lit. Press the key again to quit this mode and return to default.</p> <p>With combined use of the Shift key , the [alpha] key delivers a maximum of six input modes to the physical keypad. Mode availability however depends on keypad type, numeric or QWERTY. On a numeric keypad, 6 text input modes are provided, while on a QWERTY keypad, 2 modes are available.</p> <p>The icons       on the Title Bar signify current input state.</p> <ul style="list-style-type: none"> ▶ Numeric keypad input modes triggered by [Alpha] key: <table border="1" data-bbox="432 1469 1406 1693"> <thead> <tr> <th>Mode</th> <th>Description</th> </tr> </thead> <tbody> <tr> <td>  </td> <td>Physical keypad enters an alphabetic character indicated in blue for the first key pressed.</td> </tr> <tr> <td>  </td> <td>Physical keypad enters alphabetic character indicated in blue for all keys pressed.</td> </tr> </tbody> </table> <ul style="list-style-type: none"> ▶ QWERTY keypad input modes triggered by [Alpha] key: <table border="1" data-bbox="432 1738 1406 1962"> <thead> <tr> <th>Mode</th> <th>Description</th> </tr> </thead> <tbody> <tr> <td></td> <td>Physical keypad enters a number or symbol indicated in blue for the first key pressed.</td> </tr> <tr> <td></td> <td>Physical keypad enters numbers or symbols indicated in blue for all keys pressed.</td> </tr> </tbody> </table>	Mode	Description	  	Physical keypad enters an alphabetic character indicated in blue for the first key pressed.	  	Physical keypad enters alphabetic character indicated in blue for all keys pressed.	Mode	Description		Physical keypad enters a number or symbol indicated in blue for the first key pressed.		Physical keypad enters numbers or symbols indicated in blue for all keys pressed.
Mode	Description												
  	Physical keypad enters an alphabetic character indicated in blue for the first key pressed.												
  	Physical keypad enters alphabetic character indicated in blue for all keys pressed.												
Mode	Description												
	Physical keypad enters a number or symbol indicated in blue for the first key pressed.												
	Physical keypad enters numbers or symbols indicated in blue for all keys pressed.												

NUMERIC KEYPAD









Numeric keypad wedges a set of character keys at the lower half. They are laid out analogously to a telephone keypad, and additionally featured are an **Esc** key, Tab key \leftrightarrow , Enter key \leftarrow , Backspace key \leftarrow , and Shift key \uparrow that enable more sophisticated text input.

Numeric keypad enters numbers 0 through 9 by default. Symbols * through) and alphabetic characters can be entered by combined use of the [Alpha] key \square and Shift key \uparrow . See [Keypad Modes](#) for more details.









Key	Description
Esc	<ul style="list-style-type: none"> Opens the previous screen worked on. Closes a menu of an application, or an opened dialog.
Tab \leftrightarrow	<ul style="list-style-type: none"> Navigates among the highlight items in some applications. Enters Tab character, which means it moves the caret to the next tab stop.
Enter \leftarrow	Executes a command or confirms input. For text input, it inserts a break between paragraphs.
Backspace \leftarrow	Erases the characters to the left of caret.
Space \leftarrow	Inserts a blank space where caret is.
Shift \uparrow	<p>Shift key \uparrow changes keypad input mode of keys 0-9. When Shift key is pressed once, [Shift] mode is activated temporarily, and the LED indicator next to the physical key lights up in green accordingly. This mode will end after a single key has been pressed. Upon pressing any key, keypad input mode will resume back to default, and the LED indicator will turn off.</p> <p>When Shift key key is pressed twice, [Shift] mode is activated permanently, and the LED indicator next to the physical key stays lit. Press the key again to quit this mode and return to default.</p>

KEYPAD MODES

With combined use of the [Alpha] key  key and Shift key , enables eight input modes for keys 0-9 on the physical keypad. The icons        on [Title Bar](#) signify current input state.

▶ Numeric keypad input modes:

Mode	Description (Keys 0-9)	Trigger and Withdrawal
No icon	Keypad enters numbers only.	Default mode. This mode remains until  or  is pressed.
	Keypad enters the first typed key as a symbol.	Press  once to enter this mode. Input mode returns to default once a key is pressed.
	Keypad enters all typed keys as symbols.	Press  twice to enter this mode. Input mode returns to default by pressing  again.
Mode	Description (Keys 2-9)	Trigger and Withdrawal
	Keypad enters the first typed key as an alphabetic letter.	Press  once to enter this mode. Input mode returns to default once a key is pressed.
	Keypad enters the first typed key as a capitalized alphabetic letter.	Press  and  once to enter this mode. Input mode returns to default once a key is pressed.
	Keypad enters the first typed key as a capitalized alphabetic letter.	Press  once and  twice to enter this mode. Input mode returns to default once a key is pressed.
	Keypad enters all typed keys as alphabetic letters.	Press  twice to enter this mode. Input mode returns to default by pressing  again.
	Keypad enters all typed keys as alphabetic	Press  twice and  once to enter this mode.

	letters and capitalizes the first one.	Input mode returns to default by pressing  again. OR Jumps to  mode after a single key is pressed.
	Keypad enters all typed keys as capitalized alphabetic letters.	Press both  and  twice to enter this mode. Input mode returns to default by pressing  again.



Note:

- (1) For details about  key, see [\[Alpha\] Key](#).
- (2) Only keys 2-9 are used for alphabetic input. The remaining keys "0" and "1" are used for entering symbols and/or spaces only. Refer to the blue writing engraved on the keypad to check the characters these two keys input under various [Alpha] modes.





TEXT INPUT





To enter text by numeric keypad:

▶ Numeric Input

The numeric keypad enters numbers 0-9 by default when neither  key nor Shift key  is pressed.





▶ Literal Input

- 1) To enter a single letter, press  key once so  appears on the [Title Bar](#). To enter the letter in uppercase, press Shift key  additionally to trigger  mode.

To enter multiple letters, press  key twice so  appears on the [Title Bar](#). Additionally, press Shift key  once to activate  mode and enter the first letter in uppercase, or press it twice to activate  mode in which all letters are entered in uppercase.

- 2) Continuously press a key engraved with blue writing until the character you desire is entered.

▶ Symbols Input





- 1) To enter a single symbol, press Shift key  once so  is seen on the [Title Bar](#). To enter multiple symbols, press Shift key  twice to activate  mode.
- 2) Press one or more text input keys until the desired symbol is entered.

Note there are cases when a typed letter is capitalized automatically:

- ▶ The letter follows a period mark and a blank space (because it is seen as the start of a new sentence).
- ▶ The letter is typed after a paragraph break (because it is seen as the start of a new paragraph).







QWERTY KEYPAD

QWERTY keypad also arranges its character keys in the lower half and features them in a compact “QWERTY” layout as its name suggests.







QWERTY keypad is a pared down version of an average laptop’s keyboard that bears also an **Esc** key, **Tab** key , **Enter** key , **Backspace** key , **Shift** key , and **space** key .

QWERTY keypad enters alphabetic characters by default. To enter numbers and some symbols, press [Alpha]  key. See [\[Alpha\] Key](#) for more details.















Key	Description
Backspace 	Erases the characters to the left of caret.
Enter 	Executes a command or confirms input. For text input, it inserts a break between paragraphs.
Space 	Inserts a blank space where the caret is.
Esc	<ul style="list-style-type: none"> ▶ Opens the previous screen worked on. ▶ Closes a menu of an application, or an opened dialog.
Tab 	<ul style="list-style-type: none"> ▶ Navigates among the highlight items in some applications. ▶ Enters Tab character, which means it moves the caret to the next tab stop.
Shift 	<p>Shift key  changes keypad input mode. When Shift key is pressed once, [Shift] mode is activated temporarily, and the LED indicator next to the physical key lights up accordingly. This mode will end after a single key has been pressed. Upon pressing any key, keypad input mode will resume back to default, and the LED indicator will turn off.</p> <p>When Shift key key is pressed twice, [Shift] mode is activated permanently, and the LED indicator next to the physical key stays lit. Press the key again to quit this mode and return to default.</p>

KEYPAD MODES









With combined use of the  key, Shift key  enables four input modes for the physical keypad. The icons     on [Title Bar](#) signify current input state.

► QWERTY keypad input modes:

Mode	Description	Trigger and Withdrawal
No icon	Keypad enters lowercase letters.	Default mode. This mode remains until  or  is pressed.
	Keypad enters the first typed key as a capitalized letter.	Press  once to enter this mode. Input mode returns to default once a key is pressed.
	Keypad enters all typed keys as capitalized letters.	Press  twice to enter this mode. Input mode returns to default by pressing  again.
	Keypad enters the first typed key as a number/symbol.	Press  once to enter this mode. Input mode returns to default once a key is pressed.
	Keypad enters all typed keys as numbers/symbols.	Press  twice to enter this mode. Input mode returns to default by pressing  again.

Note:



- (1) For details about  key, see [\[Alpha\] Key](#)
- (2) The following input modes are also available on the QWERTY keypad, however their functions overlap with those denoted above:



Mode	Description
	Same input as  mode.
	Same input as  mode.
	Jumps to  mode after a single key is pressed.
	Same input as  mode.



TEXT INPUT

To enter text using QWERTY keypad:

▶ Literal Input

- 1) The QWERTY keypad enters lowercase letters a-z by default when neither  key nor Shift key  is pressed.

To enter a letter in uppercase, press Shift key  so  appears on the [Title Bar](#).

To continuously type in uppercase, press Shift key  twice to trigger  mode.

- 2) Press keys to enter text as desired.

▶ Numeric or symbols Input

- 1) To enter a single number/symbol, press  key once so  appears on the [Title Bar](#).

To enter multiple numbers/symbols, press  key twice to trigger  mode.

- 2) Press a key engraved with blue-color character to enter number(s) and symbol(s) as desired.

Note there are cases when a typed letter is capitalized automatically:

- ▶ The letter follows a period mark and a blank space (because it is seen as the start of a new sentence).
- ▶ The letter is typed after a paragraph break (because it is seen as the start of a new paragraph).

CHANGE INPUT TEXT SIZE

Set the size to show typed text:

- 1) On Start screen, tap **Settings** | **System** | **Screen** | **Text Size**.
- 2) Tap **Text Size** tab.
- 3) Adjust the text size by moving the slider.
- 4) Tap the "OK" command on the softkey bar to apply the change and quit setting.

1.5.2. ONSCREEN KEYBOARD

The OS provides users with an onscreen keyboard. Compared to physical keypads, the onscreen keyboard bears more likeness to a conventional laptop's keyboard by all the modifiers keys arranged on the left edge and the "QWERTY" layout. The onscreen keyboard isn't overshadowed by physical keypads at all but outdoing them by being able to enter a series of diacritics for European languages.

Onscreen keyboard auto-opens in some applications while in others it doesn't unless you tap on a field that accepts input.

In case the onscreen keyboard doesn't open automatically, tap the keyboard icon  on the softkey bar to open it.

Onscreen keyboard opens and readies to enter lowercase letters, numbers, and a few frequently used symbols.

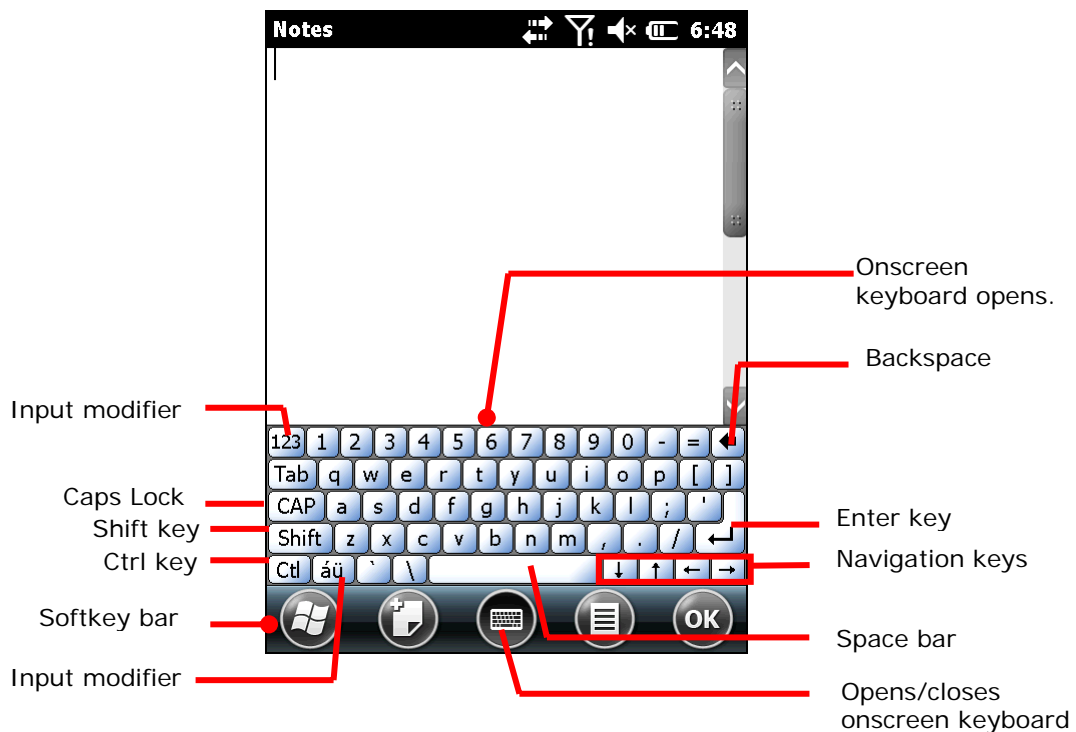

MODIFIER KEYS

Although the touchscreen is a resistive single-touch type, use of modifier keys, which normally involves hitting two keys, are still available on onscreen keyboard.

On onscreen keyboard there are five modifier keys. They all sit at the left edge. This is how they basically work:

- 1) Press a modifier key on onscreen keyboard.

The onscreen keyboard enters modifier state.

- 2) Press the second key.

The desired performance will be produced to the active application or screen at the moment.

Modifier keys are explicated as following

Key	Description
Ctrl key Ctrl	<p>Once tapped, it becomes color-inverted Ctrl and causes a special action from OS or the active application when a character key is tapped. It quits once the said action is triggered or when it is tapped again.</p> <p>For example: Tap Ctrl key and then tap key "A" to produce Ctrl+A function, which in Windows environment usually selects all content on the active screen. Once "A" is tapped, the onscreen keyboard quits Ctrl state.</p>
Shift key Shift	<p>Once tapped, it becomes color-inverted Shift and capitalizes the (one) letter typed. It quits once a character key is tapped or it is tapped again.</p> <p>To enter all caps, use Caps Lock CAP.</p>
Caps Lock CAP	<p>Once tapped, it becomes color-inverted CAP and capitalizes all the alphabetic characters typed. It doesn't quit until it is tapped again.</p> <p>This key does not affect numbers, punctuation marks, or symbols.</p>
Input modifier 123	<p>Once tapped, it becomes color-inverted 123 and presents more symbols and a set of digits and enters them. It won't quit until it is tapped again.</p> <div style="display: flex; justify-content: space-around;"> <div data-bbox="368 891 855 1536"> <p>Notes Meeting</p> <p>123 1 2 3 4 5 6 7 8 9 0 - =</p> <p>Tab q w e r t y u i o p []</p> <p>CAP a s d f g h j k l ; ' "</p> <p>Shift z x c v b n m , . / <</p> <p>Ctrl áü ` \ } ~</p> </div> <div data-bbox="882 891 1369 1536"> <p>Notes Meeting 8:00</p> <p>123 1 2 3 4 5 6 7 8 9 0 - =</p> <p>Tab q w e r t y u i o p []</p> <p>CAP a s d f g h j k l ; ' "</p> <p>Shift z x c v b n m , . / <</p> <p>Ctrl áü ` \ } ~</p> <p>When tapped it becomes color-inverted.</p> </div> </div> <p>Tap input modifier 123. And have more symbols with a set of digits.</p>

Input modifier **áü**

Once tapped, it becomes color-inverted **áü** and presents a series of accented vowels such as ä, æ, è, ì, ö, ú or letter variants such as ß and ç which are needed for European languages. It quits once a character key is tapped.

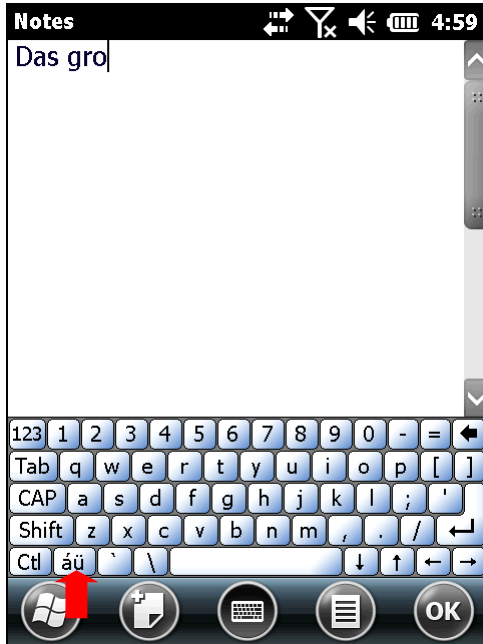

Tap **áü** key on onscreen keyboard.

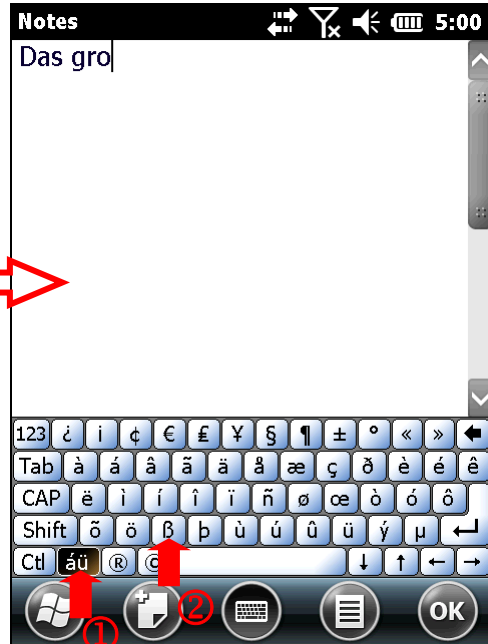

áü key becomes color-inverted **áü**. Then tap a character key.

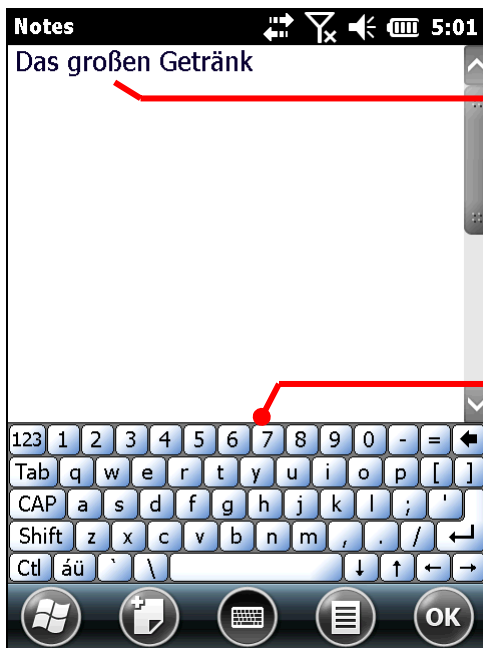

Letter variant "ß" is entered.



Once an accented vowel or letter variant is entered, the onscreen keyboard restores to English keyboard.

After the letter variant "ß" is entered, the onscreen keyboard restores to normal English alphanumeric layout.

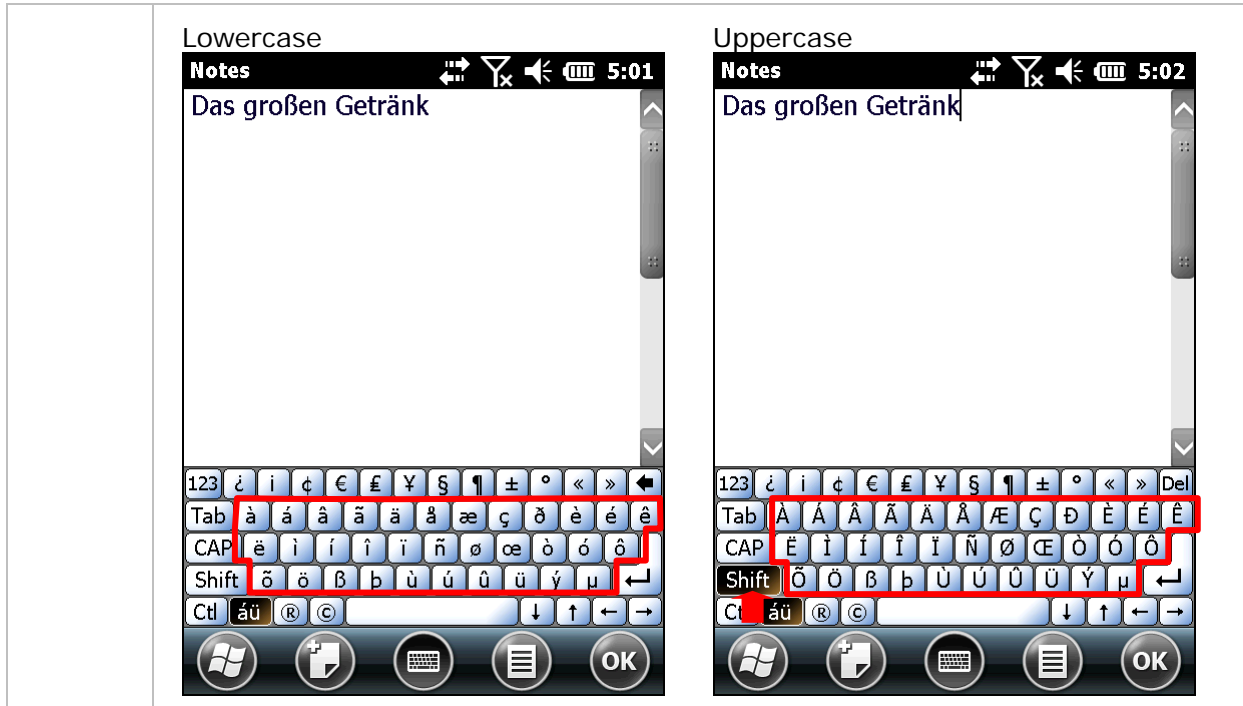
Diacritical letters and letter variants are presented both lowercase and uppercase.

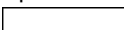

OTHER KEYS

Key	Description
Tab key 	Navigates among the highlight items in some applications. For text input, it inserts Tab character, which means it moves caret to the next tab stop.
Backspace 	Erases the characters to the left of caret.
Enter key 	Executes a command or confirms input. When text input, it inserts a break between paragraphs.
Nav	Move caret in an input field. In certain applications, they navigate vertically or horizontally among highlight items.
Spacebar 	Inserts a blank space where caret is.

DICTIONARY

Onscreen keyboard comes with an English dictionary. When onscreen keyboard is opened, the dictionary is enabled and will display a list of suggested words as you type to allow quick selection.

When you tap a letter key on the onscreen keyboard, a list of suggested words displays shortly over the keyboard. Tap a suggested word from the list to enter it. When you have entered a word that is not in the dictionary, it is added to the dictionary and becomes a suggestible word next time.

The screenshot below shows an example when "L" is entered on onscreen keyboard:

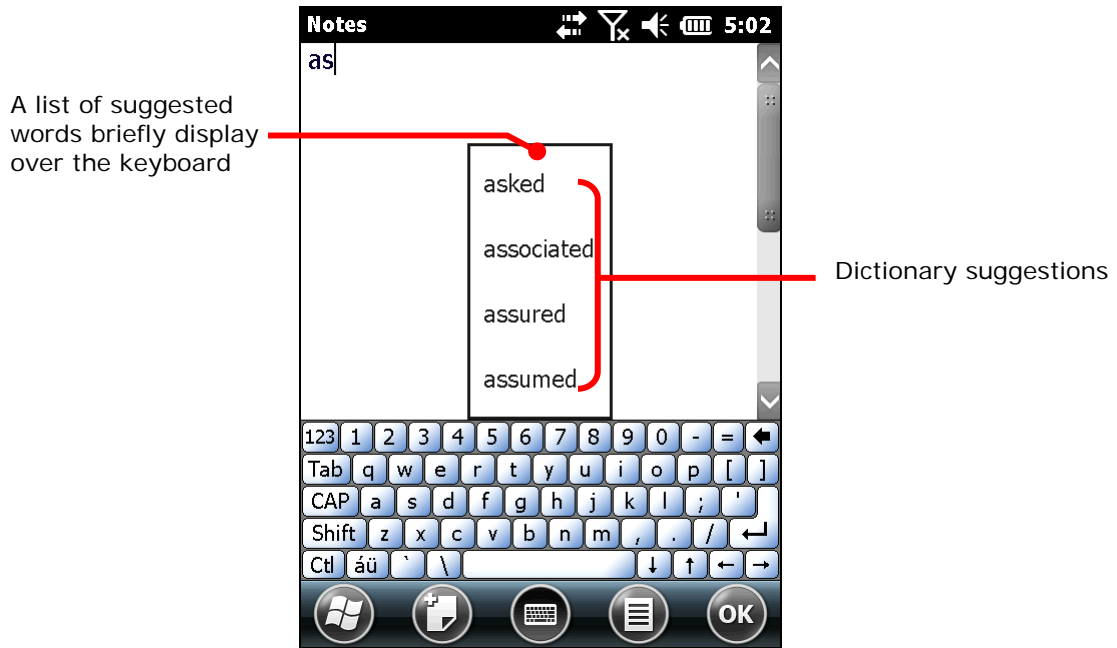

CHANGE KEYBOARD ORIENTATION

The mobile computer is built-in with a G-sensor and supports screen orientation, which is enabled by default. So when the mobile computer turns sideways or upright, the screen changes its orientation, and onscreen keyboard readjusts itself to the new orientation.

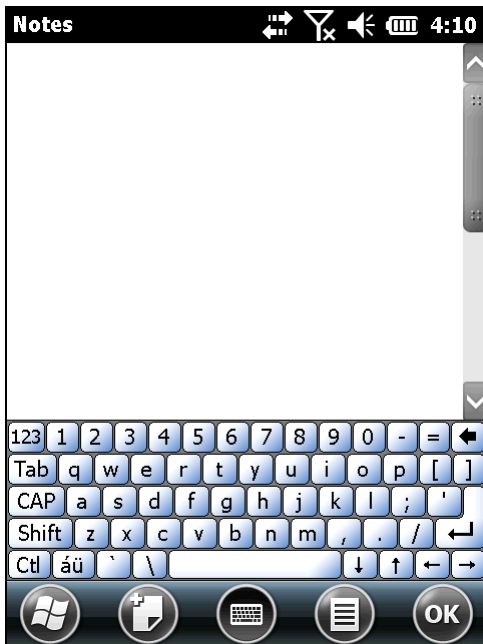

Upright (Portrait Mode)

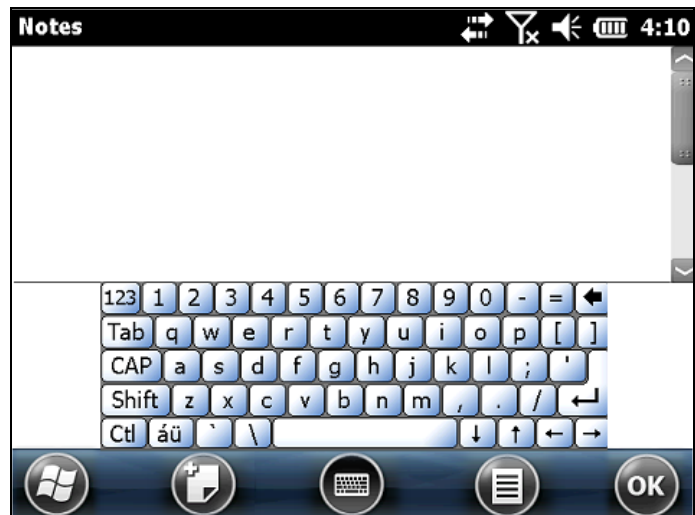

Sideways (Landscape Mode)

To disable automatic screen rotation, see [Screen Orientation](#).

CHANGE TEXT INPUT SIZE

- ▶ See [Change Input Text Size](#).

1.5.3. HANDWRITING RECOGNITION

Onscreen text input doesn't necessarily rely on onscreen keyboard. "Handwriting Recognition" can also get the job done. "Handwriting Recognition" is an input method that interprets and converts user's handwriting received through touchscreen to text.

A few handwriting "input methods" are bundled with the OS To launch them:

- 1) Tap and hold the keyboard icon  on the softkey bar
A context menu pops up.

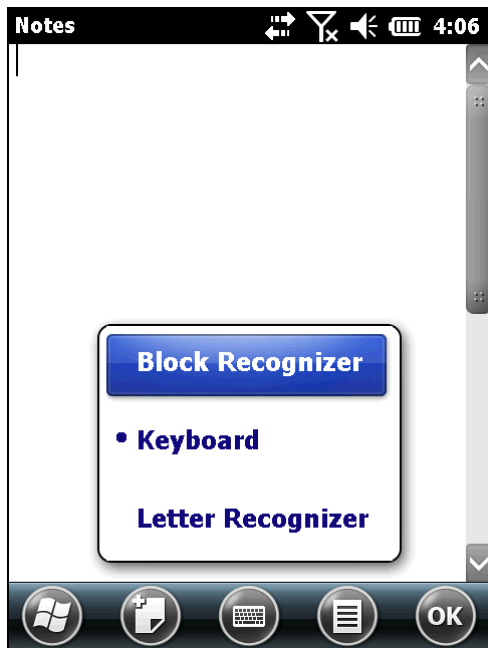

- 2) Select between **Block Recognizer** and **Letter Recognizer** for handwriting recognition.

BLOCK RECOGNIZER

This handwriting system recognizes handwriting by the particular “neography” that relies on user drawing an uppercase letter with a single stroke. The name comes from the feature of its drawing area divided to two blocks to admit each letters-drawing and numbers-drawing.

To enter text:

Write any letter, number, and punctuation with a single stroke. Block Recognizer then converts it into typed text.

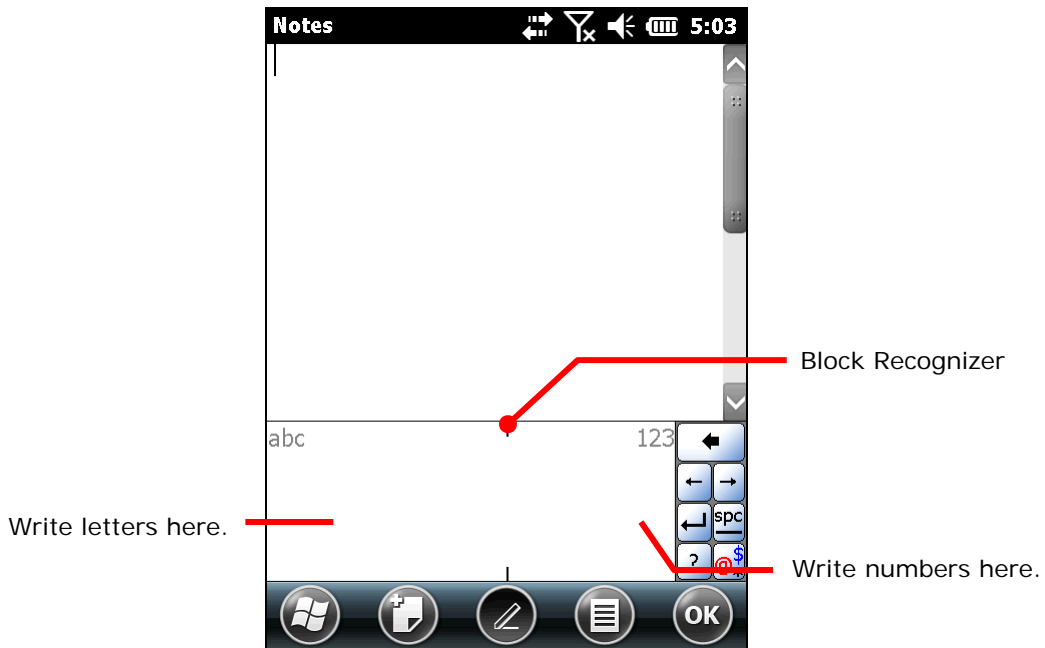

LETTER RECOGNIZER

“Letter Recognizer” presents a writing pad divided in three areas. Each respectively detects uppercase letters, lowercase letters, and numbers/symbols/punctuations.

To enter text:

Write letters, numbers, and numbers/symbols in their respective areas as desired. Letter Recognizer then converts them to typed text.

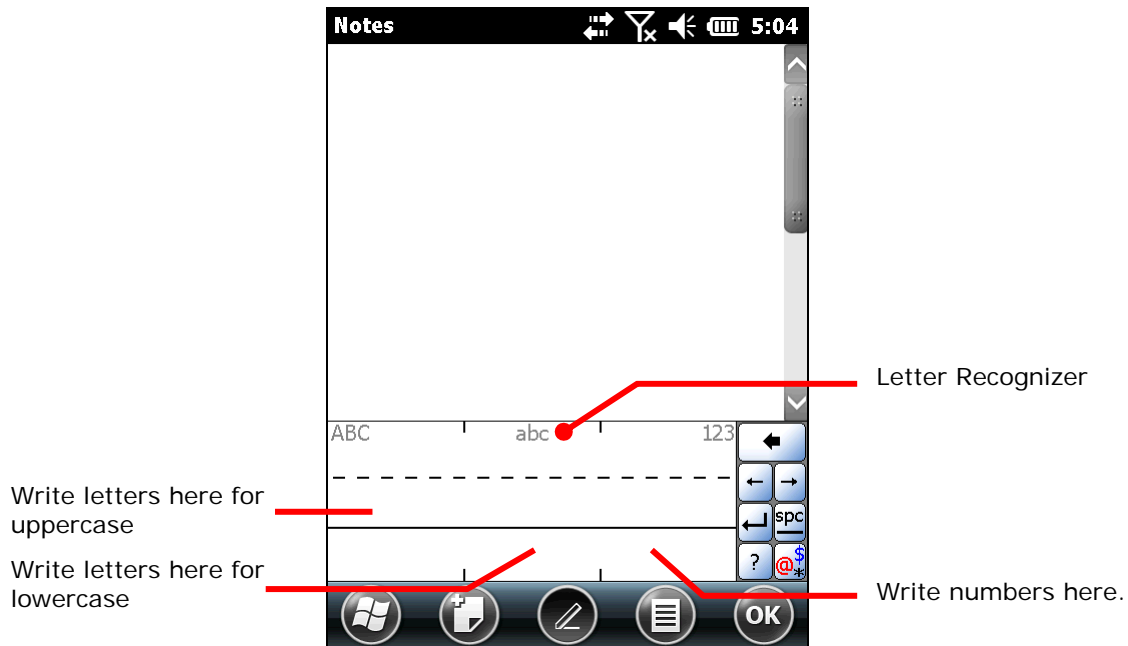

CHANGE TEXT INPUT SIZE

See [Change Input Text Size](#).

Note there are cases when a typed letter is capitalized automatically:

- ▶ The letter follows a period mark and a blank space (because it is seen as the start of a new sentence).
- ▶ The letter is typed after a paragraph break (because it is seen as the start of a new paragraph).

1.5.4. EDIT TEXT

On the mobile computer, cut, copy, and paste text within an application or across applications by the menu commands. Some applications don't support editing some or all of the text they display while others may offer their own way to edit text.

EDIT TEXT IN INPUT FIELDS

To edit text in a text input field:

- 1) Tap where you want to edit text.

Caret moves there and manifests itself as a vertical bar that blinks to indicate where the typed or pasted text will be inserted.

- 2) Type, paste or delete text.

To paste text, see [Paste Text](#).

SELECT TEXT

When you see some text on a page you want to copy, select it first. Selecting texts varies from application to application. But primarily it requires you to Tap and hold somewhere on the text to open a context menu or open the applications' option menu which provide commands to select a text.

To select a text:

- 1) Tap and hold somewhere on the text.

A context menu comes up.

- 2) Tap the command that makes selection.
- 3) Select the desired text.

It relies on defining the start and end to make selection of a text. Some applications support tapping and dragging along the text to select it while others require you to mark the start and end of the desired text with the onscreen facility featured by the application.

CUT OR COPY TEXT

After a text is selected, system then presents Copy/Cut commands on [Softkey bar](#) or a context menu shows up featuring Copy/Cut commands. Tap them to copy/cut the selected text.

PASTE TEXT

Within the OS, texts can be copied to and from different applications.

To paste a text:

- 1) Tap and hold the text field where you want to paste the text.

Context menu opens.

- 2) Tap the "Paste" command from the context menu.

The copied/cut text is pasted.

1.6. TOUCH CONTROL

The mobile computer's LCD is overlaid by a resistive touch panel and thus forms a resistive touchscreen. Since a resistive touchscreen locates the user's touch by the force applied on it, by operating with the stylus one can apply minimum force to trigger actions from the touchscreen.

Touch control is one of the main ways to interact with the mobile computer. Users are able to manipulate icons, buttons, menu commands, the onscreen keyboard, or any onscreen items with touch control.

1.6.1. USE TOUCHSCREEN

The mobile computer comes with a stylus. Touch-operate the mobile computer with the stylus. Apply the gestures below to work on the touchscreen:

- ▶ **Tap** – Touch any item on the screen such as an application icon or a setting icon to work on them, or touch any key on the onscreen keyboard to type it.
- ▶ **Tap and hold** – Touch an item on the screen and do not release until an action occurs.
- ▶ **Drag** – Touch and hold an item for a moment and then, without release, move the item onscreen until you reach the target.
- ▶ **Flick** – Quickly move the stylus across the surface of the screen. Note when the stylus contacts the screen, do not pause so you don't drag an item instead. Flick is helpful, for example, for scrolling up or down a list.
- ▶ **Double-tap** – Touch quickly twice on a webpage or other screen to zoom. For example, double-tap a section of a webpage in a web browser to zoom that section to fit the width of the screen. Some applications such as map-info applications support picture zooming with double-tap.
- ▶ **Rotate screen** – On most screens, the screen rotates as the mobile computer changes its orientations between upright and sideways.

1.6.2. SCREEN ORIENTATION

The mobile computer has a built-in G-sensor for screen orientation. In order to enable automatic screen orientation :

- 1) Tap Windows icon  on the softkey bar.
Start screen opens.

- 2) Tap **Settings | System | Screen Rotation**  .

Rotation setting opens with three orientation modes to select from and an option to suspend the mobile computer when the screen is facing down.

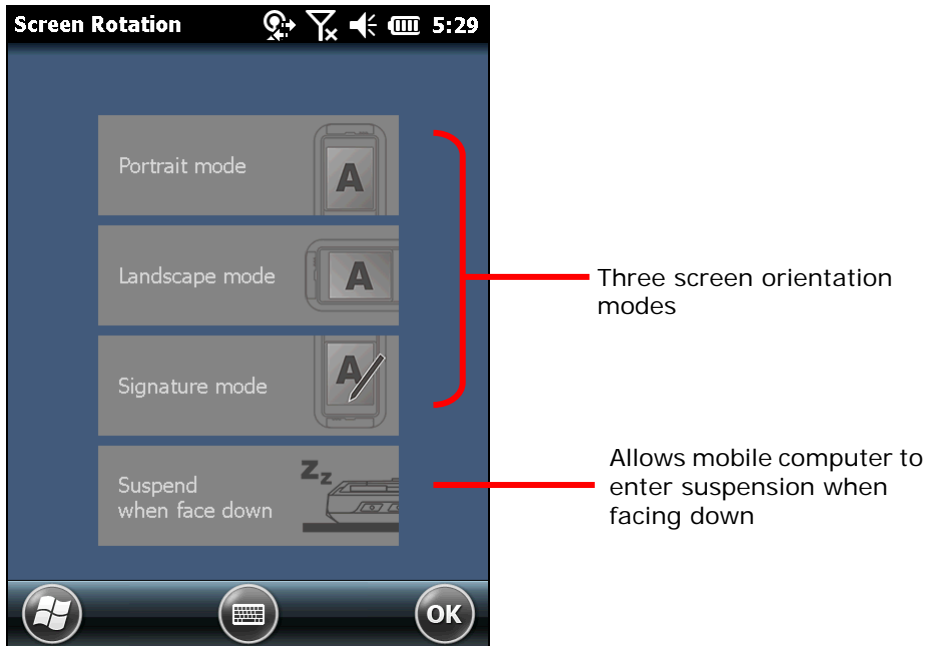

- 3) Tap the modes that you wish to enable. The tapped item will light up to indicate it is currently enabled.



- 4) Tap "OK" on the softkey bar to apply the changes.

The mobile computer will then automatically switch between the enabled modes according to its physical orientation. For instance, if **Portrait** and **Landscape** modes are enabled, the touchscreen will switch between upright and sideways view according to the user's holding position. However, if only **Portrait** (upright) mode is enabled, the touchscreen will not switch to sideways view regardless of the mobile computer's orientation.

SIGNATURE MODE

The signature mode is for combined usage with the CipherLab application **Signature**. With this mode enabled, the screen will immediately rotate 180° when the front of the mobile computer is tilted outwards, which is convenient for signing by a second party.

Note: If no modes are selected in **Screen Rotation**, the mobile computer's touchscreen will be fixed at the current setting under **Start Screen | Settings | System | Screen**.

1.6.3. ADJUST BACKLIGHT

Screen backlight can be adjusted through two ways, manually and automatically. Upon shipping the mobile computer is set to automatic adjustment, which helps saves power. Alternatively you can set the backlight manually according to your preferences.

MANUAL BACKLIGHT ADJUSTMENT

To adjust screen backlight:

- 1) Tap Windows icon  on the softkey bar.
Start screen opens.

- 2) Tap **Settings | System | Backlight Setting**  .

Brightness tabbed page opens with a checkbox to enable manual backlight setting, and slidebars for setting screen and keypad backlight levels

By default, **Manual backlight setting** is unchecked. The light sensor embedded on the front of the mobile computer will detect current lighting environments, and screen and keypad backlights will adjust automatically according to the backlight profiles set under the **Profile** tabbed page.

When **Manual backlight setting** is checked, screen and keypad backlights will stay at the set level and will not adjust automatically.

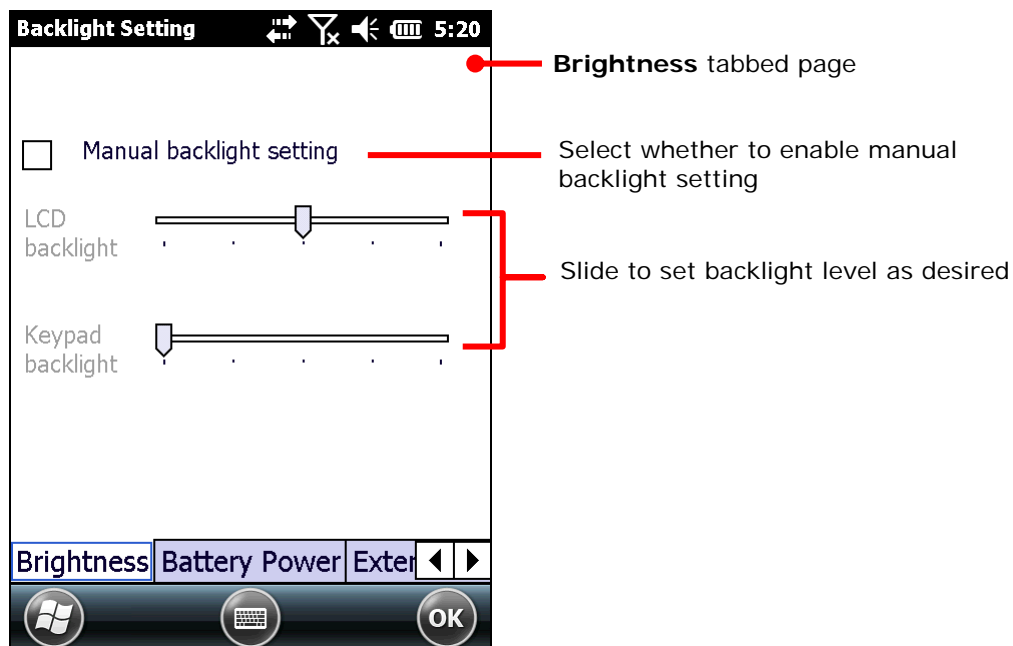

- 3) Tap **OK** on the softkey bar to apply the settings.

AUTOMATIC BACKLIGHT PROFILES

The mobile computer stores three backlight profiles to represent backlight level under different environments. These can be configured according to user's likings.

To set backlight profiles:

- 1) Tap Windows icon  on the softkey bar.
Start screen opens.

- 2) Tap **Settings | System | Backlight** .
Brightness tabbed page opens.

- 3) Uncheck **Manual backlight setting** to enable profile function.
4) Switch to the **Profile** tabbed page.

Three profiles, **Dark**, **Bright**, and **Brightest** are available in the drop-down box. Select the profile you would like to modify and use the slidebars below to set the backlight levels to your preferences. The screen backlight will change temporarily to indicate the effect.

To restore profile settings to default, tap the **Default** button at the top right corner.

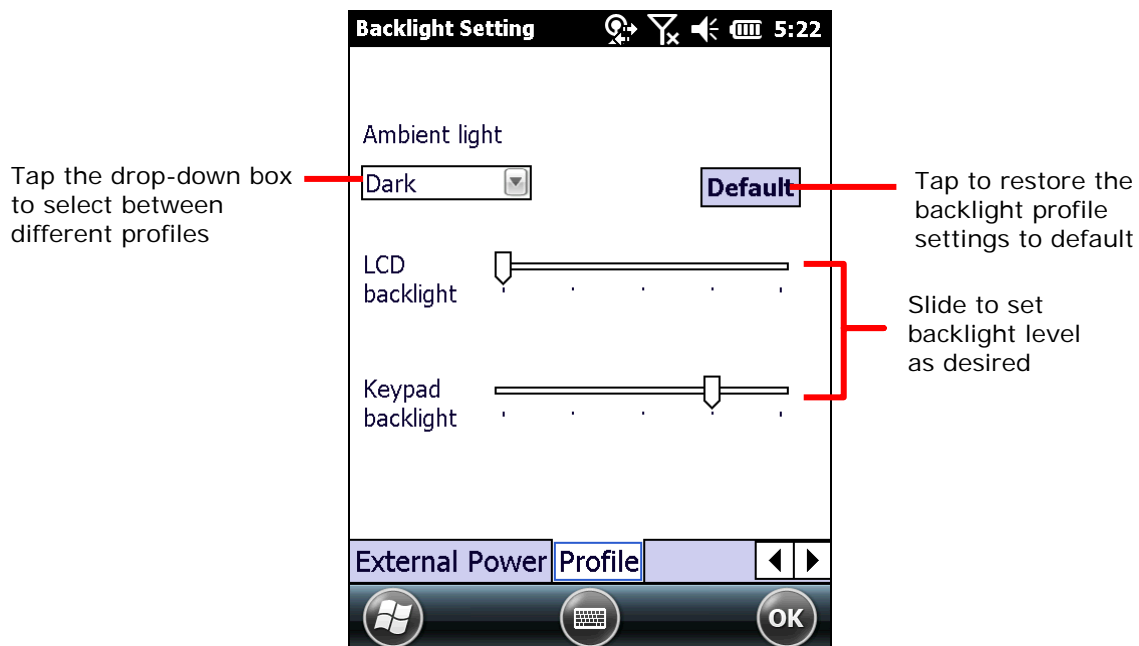

- 5) Tap **OK** on the softkey bar to apply the settings.

1.6.4. CALIBRATION

A resistive touchscreen needs calibration to work accurately after serving for a period of time. Calibration aligns the coordinates of touch panel and the LCD underneath to improve touch accuracy.

To calibrate touchscreen:

- 1) Tap Windows icon  on the softkey bar.

Start screen opens.

- 2) Tap **Settings** | **System** | **Screen** .

Screen settings open showing **General** tabbed page.

- 3) Tap Align Screen button.

Screen alignment application opens.

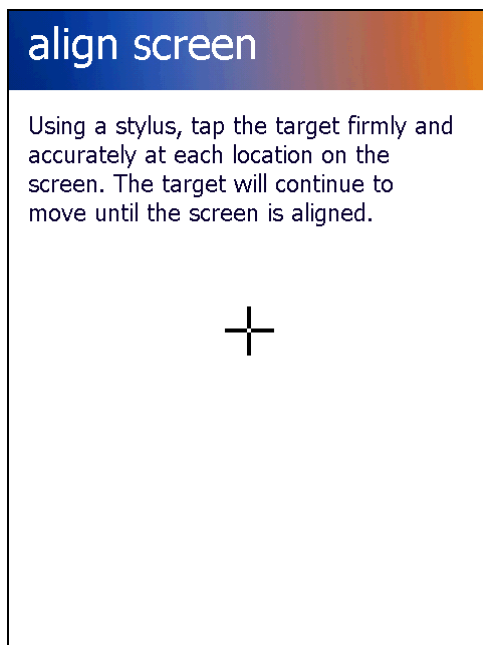

- 4) Using the stylus, tap firmly at the center of the cross that appears onscreen. Five crosses will appear in sequence.

When calibration is completed, **General** tabbed page under Screen settings will re-appear.

1.7. MEMORY

The mobile computer packs the following memory units to retain data and instructions from users:

- ▶ Random-access Memory (RAM)

512 MB SDRAM for temporary storage and fast access of active applications. When the main battery pack is absent, SDRAM is fed by backup battery to retain data.

- ▶ Internal Storage

4GB flash memory to store OS (Windows Embedded Handheld 6.5), application files, settings, and other data used by applications.

- ▶ External Storage

Insert a storage card to increase the mobile computer's storage capacity. Supported are MicroSDHC cards up to 32GB.

1.7.1. DATA LOSS CAUTION

When main battery is absent or used up, backup battery on the main board takes over to supply power to the mobile computer. A fully charged backup battery retains SDRAM data and suspends the mobile computer for 30 minutes.

Note if you are leaving the mobile computer to sit for a couple of days, data loss is to occur when both main and backup batteries drain out. Consider backing up data before putting away the mobile computer.

1.7.2. CHECK STORAGE

RAM SIZE

To check RAM size:

From start screen, tap **Settings** | **System** | **System**

Information . The application opens revealing information about the mobile computer's assemblage and hardware/firmware components, including device manufacturer, device ID, memory size, and firmware/software version. RAM size will be listed among this info.

Tap to view information on
memory size

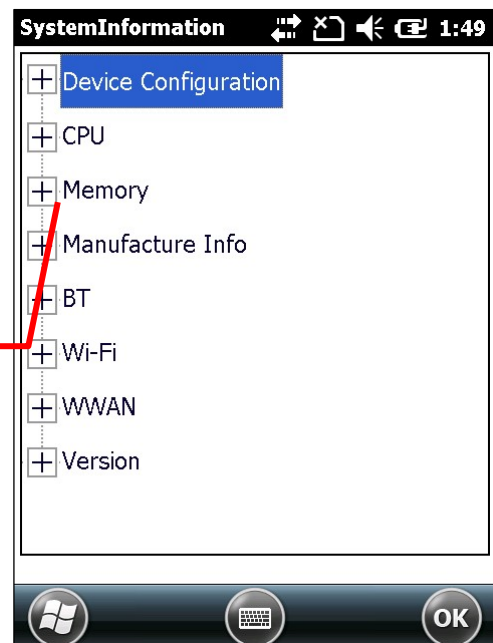

INTERNAL STORAGE

On Start screen, tap **Settings** | **System** | **Memory** . Memory screen opens showing **Main** tabbed page. This page gives the information about the mobile computer's use of RAM and internal storage.

Main tabbed page delivers two labels – **Storage** and **Program**:

- ▶ **Storage** - Internal memory for files storage, such as OS, applications and the files needed for applications.
- ▶ **Program** - RAM usage for running applications.

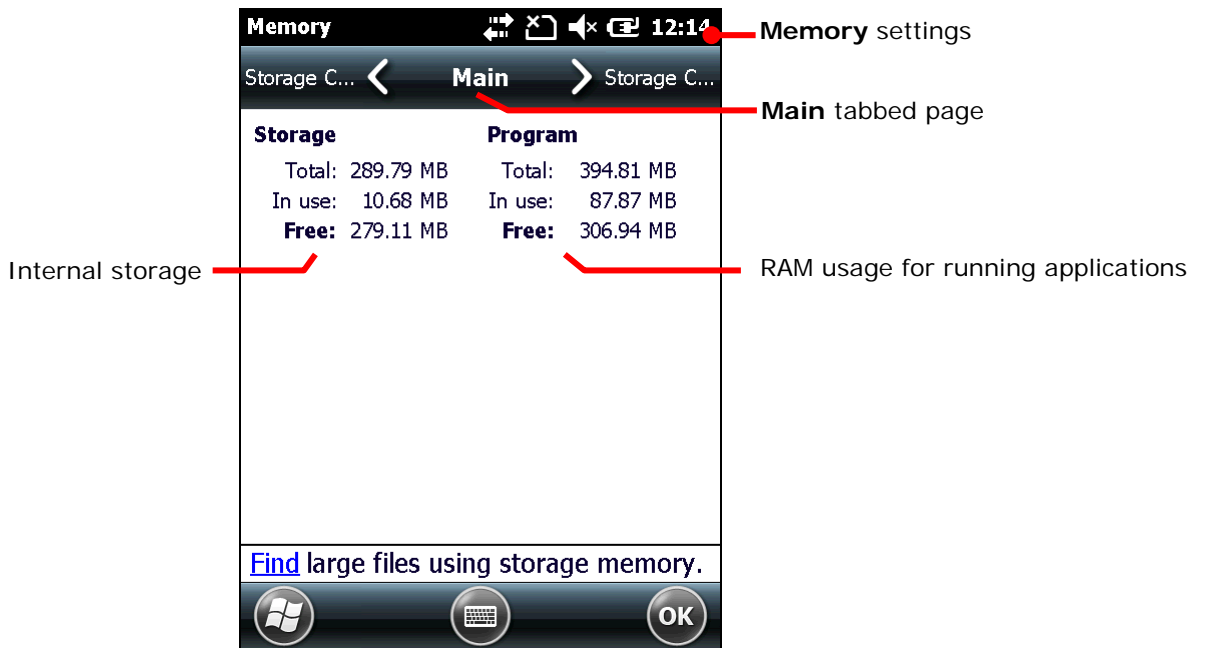

EXTERNAL STORAGE

When Memory screen opens, tap **Storage Card** tab. **Storage Card** tabbed page then opens and shows the info about external storage (when a storage card is inserted).

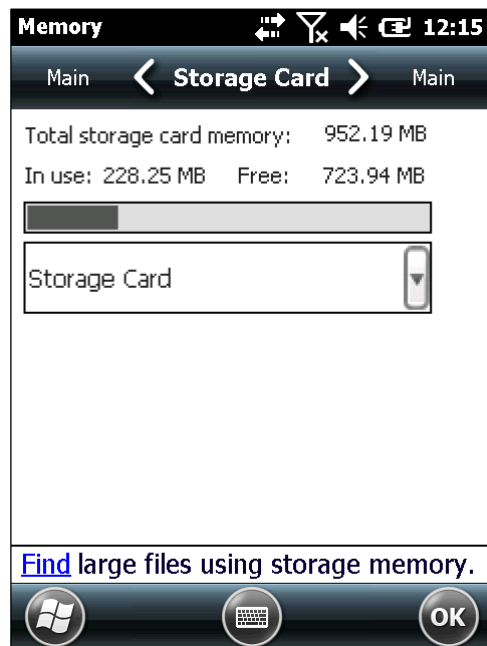

1.7.3. INSERT SD CARD

Day-to-day use of the mobile computer might cause the available internal storage to run short. Equip the mobile computer with an external memory unit to expand storage capacity.

Follow the steps below to install a SD card:

- 1) Power off the mobile computer.
- 2) Place the mobile computer face-down on a flat and soft surface.
- 3) Remove the battery door and main battery pack as described in [Main Battery Setup](#).

Battery chamber is opened.

- 4) Using a screwdriver, remove the battery chamber back cover.
- 5) Locate the SD card socket inside battery chamber. (See [Inside Battery Chamber](#).) The SD card socket is equipped with a hinged cover.

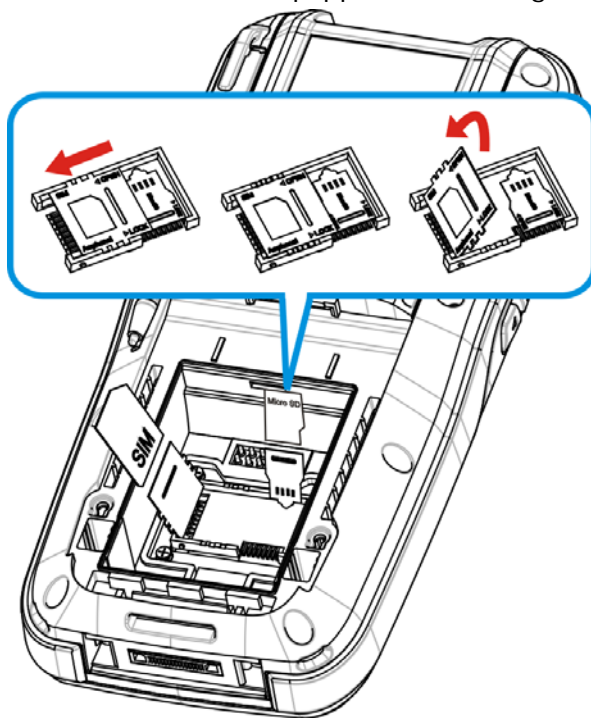

- 6) Push the hinged cover to the open position.
- 7) Swivel up the cover.
- 8) Insert SD card into the cover slot in the direction indicated . The metal contact pins should face down.
- 9) Put down the hinged cover and lock it into place.
- 10) Restore the battery chamber back cover, main battery pack and the battery door.

Figure 10: Inserting SD Card

1.8. DIRECT DATA COMMUNICATION

“Direct” data connection means “hardwired” data connection between the mobile computer and a Windows-based PC as opposed to wireless connection. Direct data connection relies on a RS-232 cable or a USB cable (sometimes plus an auxiliary cradle) between the two mentioned devices. Once the mobile computer and PC are “directly” connected with each other by a RS-232 or USB-cable, they can sync data with each other.

1.8.1. USE CABLE

Direct data communication using a cable:

- 1) Connect the mobile computer to your PC with a USB or RS-232 type Snap-on Charging and Communication Cable.
- 2) On the mobile computer, tap **Start Screen | Settings | System | USB Connection**.
- 3) To connect the mobile computer and PC via ActiveSync, select **ActiveSync Advance Network Mode** or **ActiveSync Serial Mode**.

To treat the mobile computer as an external storage, select **Mass Storage – SD Card**.

- 4) Tap **OK** on the softkey bar to apply the settings.

If one of the first two options are selected, ActiveSync will automatically detect connection between the two and prompt for data synchronization.

See [Syncing Tools](#) and subsequent sections to know how to use ActiveSync.



Figure 11: Direct Data Communication Using Cable

1.8.2. USE CRADLE

Direct data communication using a cradle:

- 1) Seat the mobile computer in a Charging and Communication Cradle (hereinafter "cradle").
- 2) Connect the cradle to your PC with a USB cable. Fix the cable to both sides.

ActiveSync will automatically detect connection between the two and prompt for data synchronization.

See [Syncing Tools](#) and subsequent sections to know how to use ActiveSync.

Note: The cradle supports USB Host Mode via a USB OTG cable.



Figure 12: Direct Data Communication Using Cradle

1.8.3. SYNCING TOOLS

Microsoft's syncing tools enables users to update or back up the data on their handheld computers to desktop computers.

Two syncing tools are featured by Microsoft - ActiveSync and Windows Mobile Device Center (hereinafter "WMDC"). Which tool to use depends on which OS is running on your PC. See the rule below:

OS	Syncing Program
Windows Vista or Windows 7	WMDC 
Windows XP SP3 and earlier	ActiveSync 

ActiveSync and WMDC can be downloaded from Microsoft's website. Download and install the right one on your PC.

Hereafter in this manual, we will focus on ActiveSync only. For WMDC usage, see its documentation or help file.

1.8.4. SYNC PARTNERSHIP

Once a direct connection is established between the mobile computer and your PC as described in [Use Cable](#) or [Use Cradle](#), they are able to form the following ties:

Sync Partnership	Services
Synchronization Relationship	<ul style="list-style-type: none"> ▶ Allows the mobile computer and PC to sync Microsoft Office Outlook data with each other. ▶ Allows PC to add and remove programs to/from the mobile computer. ▶ Allows PC to browse files on the mobile computer. ▶ Allows PC to copy files to/from the mobile computer. ▶ Allows PC to back up the files on the mobile computer.
Temporary Relationship (Mobile computer works as a "guest" to PC)	<ul style="list-style-type: none"> ▶ Allows PC to add and remove programs to/from the mobile computer. ▶ Allows PC to browse files on the mobile computer. ▶ Allows PC to copy files to/from the mobile computer. ▶ Allows PC to back up the files on the mobile computer.

Note that data stored on external storage (the SD card) cannot be synchronized.

See [ActiveSync Actions to Take](#) that details each mentioned service.

1.8.5. 1ST USB SYNC

This section will guide you through USB syncing. For Bluetooth syncing, see [Bluetooth ActiveSync](#).

To connect ActiveSync using USB:

- 1) Download the right syncing tool as described in [Syncing Tools](#) and install it on your PC.
- 2) Connect the mobile computer and your PC as described in [Use Cable](#) or [Use Cradle](#).
- 3) On your PC, run the syncing program.

ActiveSync should detect the mobile computer. **Sync Setup Wizard** launches and prompts to set up [Sync Partnership](#) between two computers.

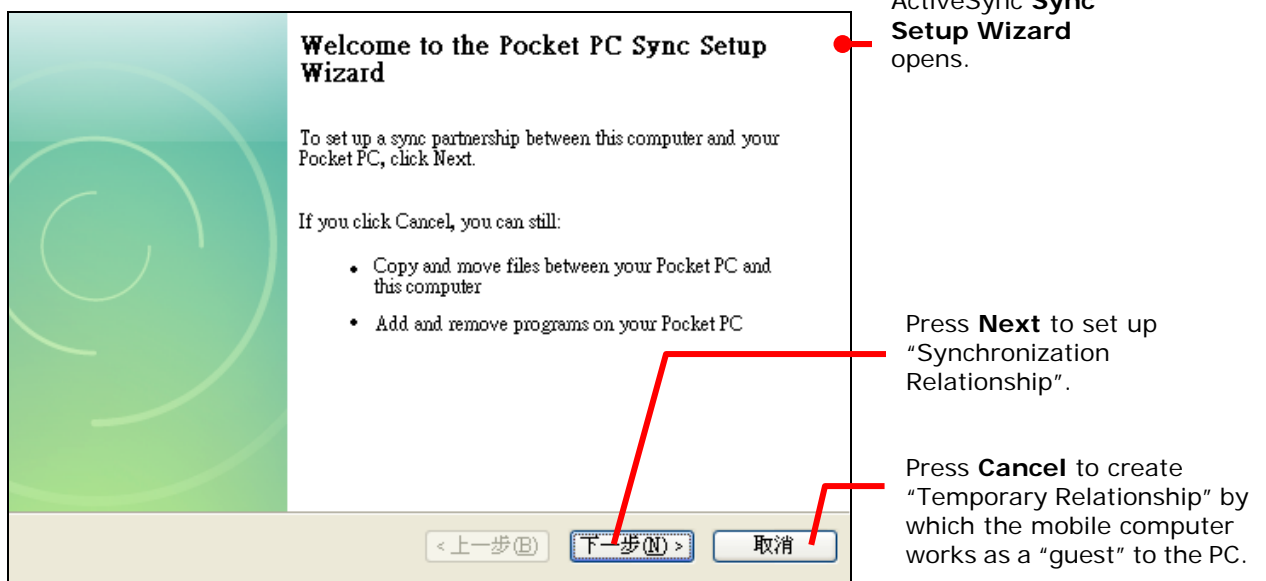

- 4) Press **Next** for "Synchronization Relationship", or press **Cancel** for "Temporary Relationship" if you don't plan to connect to the PC on a regular basis.

If you have pressed **Next**, follow the onscreen instructions and select the data categories you would like to synchronize. Once confirmed, synchronization will begin shortly, and when the process is finished, ActiveSync window will show “Synchronized” to indicate that the data on the mobile computer and PC are identical.

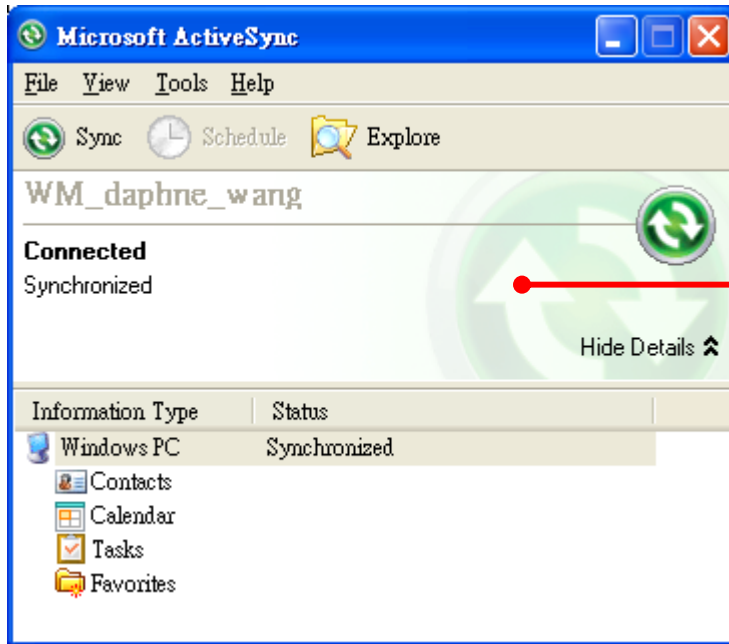

A “Synchronization Relationship” is established between the mobile computer and the PC

OR

If you have pressed **Cancel**, Microsoft ActiveSync opens showing “Guest” and “Connected”. The mobile computer and the PC are connected but the data is not synchronized.

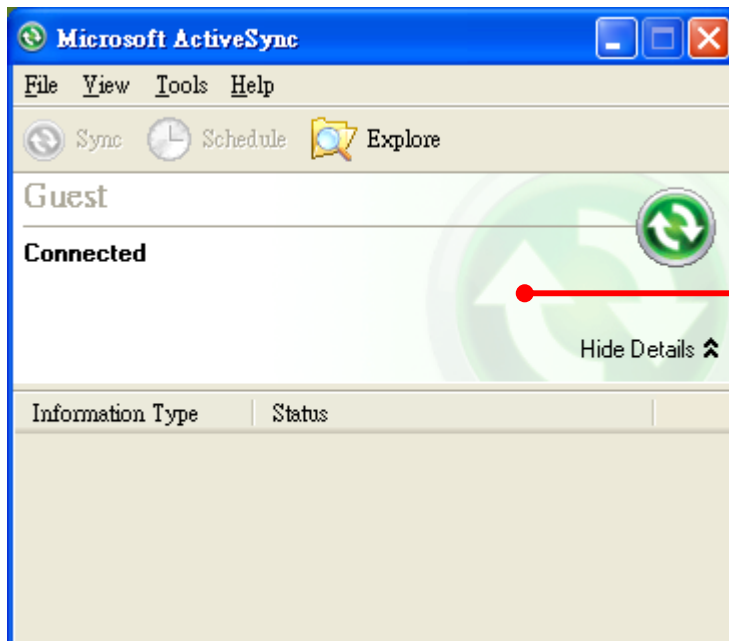

A “Temporary Relationship” is established between the mobile computer and the PC

1.8.6. DISCONNECT USB ACTIVESYNC

To disconnect USB ActiveSync:

- 1) On your PC, open ActiveSync by double-clicking its icon  in the notification area. ActiveSync opens.
- 2) From the menu bar, click **File | Connection Settings**.
[Connection Settings] window opens.
- 3) Deselect **Allow USB connections**.
- 4) Press the **OK** button to apply the change and quit setting.

This way when you plug your mobile computer the next time, it still gets charged but ActiveSync won't attempt to synchronize with it.

To disconnect Bluetooth syncing, see [Disconnect Bluetooth ActiveSync](#).

1.8.7. ACTIVESYNC ACTIONS TO TAKE

Once “Synchronization Relationship” or “Temporary Relationship” is established between two computers, a variety of actions can be taken to enhance resource sharing between them as previously mentioned in [Sync Partnership](#).

In summary, “Synchronization Relationship” outshines “Temporary Relationship” by being capable of syncing Microsoft Office Outlook data. However “Temporary Relationship” provides satisfactory file sharing if you don’t want to synchronize information.

See the following to know what actions to take with ActiveSync:

CHANGE MICROSOFT OFFICE OUTLOOK DATA TO SYNCHRONIZE

Note this is for “Synchronization Relationship” only.

In default state, “Synchronization Relationship” doesn’t synchronize all Microsoft Office Outlook data but only a limited amount between two computers in order to save storage on the mobile computer. You can change the amount of information to synchronize:

- 1) On your PC, from the menu bar of ActiveSync, select **Tool | Options**.

ActiveSync’s **[Settings]** window opens showing Options tabbed page.

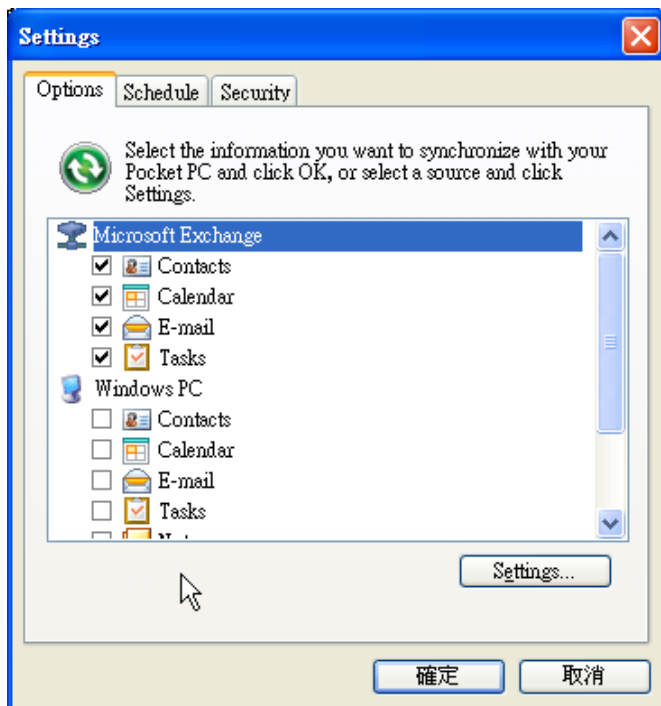

- 2) Select an information type to synchronize, and deselect an information type to stop synchronizing.
- 3) Press OK button to save the change and quit setting.

Note you can also change the information to synchronize on the mobile computer by disconnecting ActiveSync first as mentioned in [Disconnect USB ActiveSync](#) or [Disconnect Bluetooth ActiveSync](#) and then tap ActiveSync’s “Menu” command on the softkey bar and tap **Options**.

ADD/REMOVE PROGRAMS

Note basically the applications to be installed to the mobile computer need to be installed on your PC first. So download the application programs to your PC first and install them on your PC so they can be installed onto the mobile computer later.

Many application programs are installed in different ways. Read their installation guides or documentation to know how they are installed. If you are installing an application that cannot be installed on your PC first, try to install it right from the mobile computer, see [Download & Install Applications](#) for more details.

To install an application on the mobile computer:

- 1) Connect two computers as described in [Use Cable](#) or [Use Cradle](#).
- 2) Sync two computers as described in [1st USB Sync](#).
- 3) On the PC, from the menu bar of ActiveSync, select **Tools | Add/Remove Programs**.

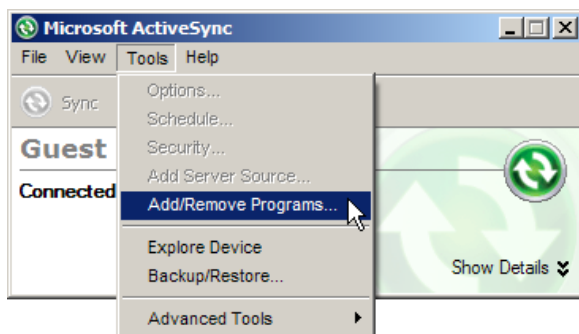

ActiveSync starts to search for the application programs installed on your PC and opens its [**Add/Remove Programs**] dialog which lists those found. Each entry comes with a check box on the left. An unchecked box means the program is yet to install to the mobile computer while a checked one means an installed program.

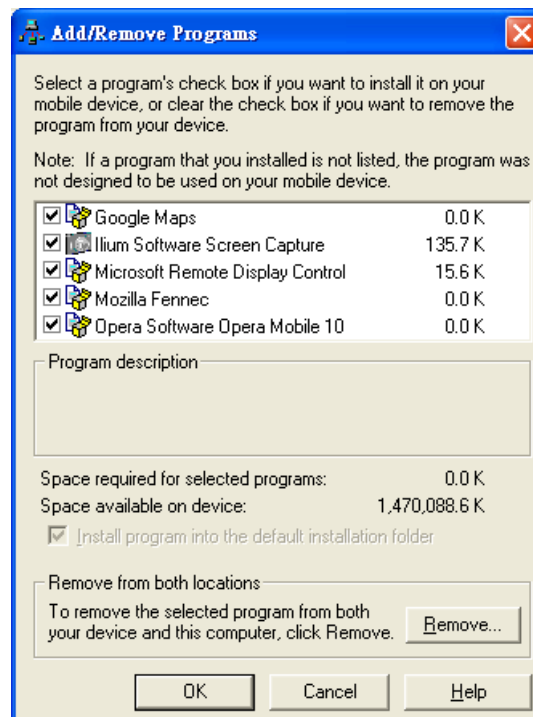

- 4) Select the application program(s) to install to the mobile computer, and deselect the application program(s) to uninstall from the mobile computer.
- 5) Press the **OK** button.

ActiveSync proceeds to install programs and/or remove programs to/from the mobile computer.

- 6) Follow the onscreen instructions on both your PC and the mobile computer to proceed.

Noteworthy facts:

- ▶ Normally the application program(s) downloaded from external resources are installed to the mobile computer's directory at **Mobile Device\Program Files**. However sometimes there are exceptions and it depends on the application.
- ▶ You can uninstall application(s) right by the mobile computer rather than on the PC. See [Uninstall Applications](#) for more details.
- ▶ If you would like to uninstall a program isn't listed in the **[Add/Remove Programs]** dialog, browse to it on the mobile computer using **Start Screen | File Explorer** . Tap and hold it, and select **Delete** from the context menu that pops up.

ADD APPLICATION SHORTCUTS TO START SCREEN

ActiveSync features "Explore" to add an application shortcut to Start screen where it is easier to launch the application.

To add an application shortcut to Start screen:

- 1) Connect two computers as described in [Use Cable](#) or [Use Cradle](#).
- 2) Sync two computers as described in [1st USB Sync](#).
- 3) On the PC, from ActiveSync's menu bar, select **Tools | Explore Device**, or from its toolbar, press **Explore**  button.

The mobile computer's internal storage's root directory "**Mobile Device**" opens presenting a few folders (and files).

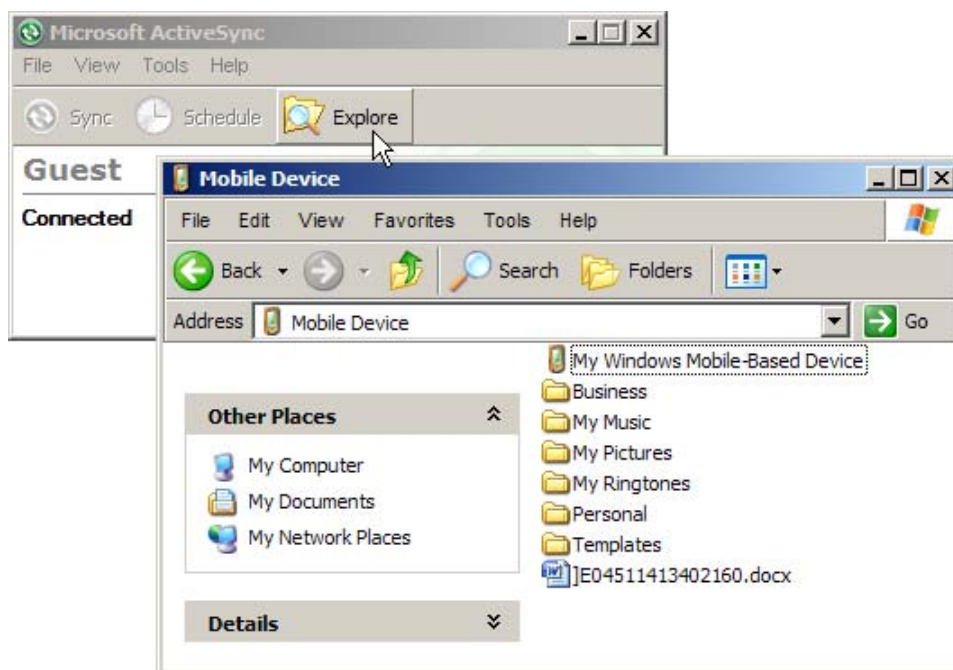

- 4) Double-click **My Windows Mobile-Based Device** .
My Windows Mobile-Based Device opens.
- 5) Double-click **Program Files**.
Program Files folder opens. This is where the downloaded applications are normally installed on the mobile computer's local storage.
In the folder, each sub-folder stores an application.
- 6) Open the folder of the application to create shortcut for.
- 7) Find the executable file of that application. Right-click on it and select **Copy** from the context menu that comes up.
The executable file is copied.
- 8) Browse to **My Windows Mobile-Based Device\Windows\Start Menu\Programs**.
Programs folder opens.
- 9) Right-click any vacant spot in the folder and select **Paste shortcut** from the context menu that comes up.
A shortcut to the application is added to Start screen.

Note: You can also copy & paste by the sequence **Create Shortcut -> Cut -> Paste**.

You can also add an application shortcut to Start screen right by the mobile computer. See [Add Items to Start Screen](#) for more details.

ADD FILE SHORTCUTS TO START SCREEN

ActiveSync features "Explore" to add to Start screen a shortcut to some local file so it is accessible more easily.

To add a file shortcut to Start screen:

- 1) Connect two computers as described in [Use Cable](#) or [Use Cradle](#).
- 2) Sync two computers as described in [1st USB Sync](#)
- 3) On the PC, from ActiveSync menu bar, select **Tools | Explore Pocket PC**, or from its toolbar, press **Explore**  button.
The mobile computer's internal storage root directory "**Mobile Device**" opens presenting a few folders.
- 4) Browser for the file to create shortcut for.
- 5) Right-click on the file and select **Copy** from the context menu that comes up.
- 6) Browse to **My Windows Mobile-Based Device\Windows\Start Menu\Programs**.
Programs folder opens.
- 7) Right-click any vacant spot in the folder and select **Paste shortcut** from the context menu that comes up.
A shortcut to the file is added to Start screen.

Note: You can also copy & paste by the sequence **Create Shortcut -> Cut -> Paste**.

You can also add a file shortcut to Start screen right by the mobile computer. See [Add Items to Start Screen](#) or more details.

REMOVE SHORTCUTS FROM START SCREEN

Note the inherent shortcuts aren't removable. Only the added shortcuts are removable.

To remove an added shortcut from Start screen, simply use ActiveSync's **Explore**  to delete the shortcut from **My Windows Mobile-Based Device\Windows\Start Menu\Programs** folder.

You can also remove an added shortcut from Start screen right by the mobile computer. See [Remove Items from Start Screen](#) for more details.

CREATE NEW FOLDERS

To create a new folder on the mobile computer:

- 1) Connect two computers as described in [Use Cable](#) or [Use Cradle](#).
- 2) Sync two computers as described in [1st USB Sync](#).

On the PC, from ActiveSync menu bar, select **Tools | Explore Pocket PC**, or from its toolbar, press **Explore**  button.

The mobile computer's internal storage root directory "**Mobile Device**" opens presenting a few folders (and some files).

- 3) Browse where you want to create a folder.
- 4) Right-click any vacant spot there.

Context menu opens

- 5) Select **New Folder**.

A new folder is created.

BACKUP DATA

To best protect your work, back up regularly the data on your mobile computer. Manually back up using ActiveSync by either "Synchronization Relationship" or "Temporary Relationship" with simple copy & paste to back up files to your PC.

USB PASS-THROUGH NETWORKING

ActiveSync supports "Pass-Through Networking" whereby the mobile computer networks using your PC's data connection.

For security, disable the network bridging on the PC, especially the bridging to a Remote NDIS adapter. For more information on network bridging, see Windows Help on the PC.

After sync partnership is up between the mobile computer and your PC:

- 1) On your PC, from the menu bar of ActiveSync, select **File | Connection Settings**.
[Connection Settings] window opens.
- 2) For **This computer is connected to**, select a network which your PC should connect to when passing through ActiveSync. Options are:

Option	Description
Automatic	Auto-detects proxy <ul style="list-style-type: none">▶ This option detects if a proxy should be used when passing connections through the PC. If yes, configure the proxy on the mobile computer.▶ This option best suits connecting to a PC (laptop) that may be used at home (with no proxy), as well as to a corporate network (with proxy).
Work Network	Always uses proxy <ul style="list-style-type: none">▶ This option assumes a proxy should be used when passing connections through the PC, and uses whatever proxy is already configured on the mobile computer.▶ This option best suits connecting to a PC that is always on corporate network.
The Internet	Never uses proxy <ul style="list-style-type: none">▶ This option assumes no proxy is necessary when passing connections through the PC.▶ This option best suits connecting to a PC connected directly to the Internet through ISP (at home)

- 3) Select **Open ActiveSync when my device connects**.
- 4) Press **OK** button to apply the change and quit setting.

To pass-through network using Bluetooth, see [Bluetooth Pass-through Networking](#).



Also compare with [USB Internet Sharing](#).

1.9. AUDIO PLAYBACK

Use a headset for audio playback and hands-free telephone communication. Bluetooth headsets are supported to deliver better mobility. See [Use Bluetooth](#)

1.9.1. VOLUME CONTROL

The mobile computer has two volume control facilities – the physical volume rocker perched on the waist of the mobile computer and the onscreen volume gauges featured by the OS

Both the physical rocker and the onscreen gauge can be used to control the system volume (media playback and event/notification sounds). When the system volume is enabled, the OS shows an  icon on [Title Bar](#); otherwise it shows .

PHYSICAL VOLUME ROCKER

Use physical volume rocker to turn up and down system volume.

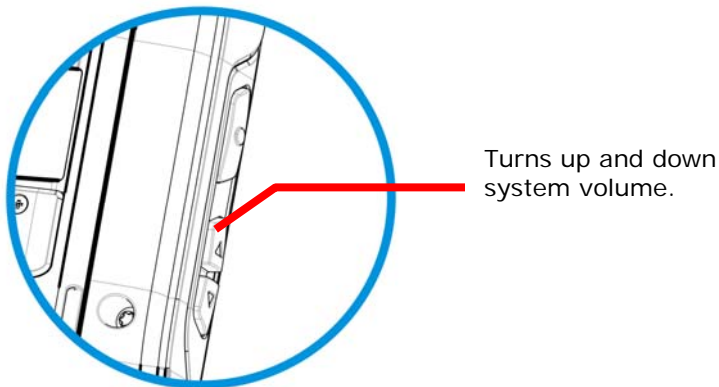



Figure 13: Physical Volume Rocker

ONSCREEN VOLUME GAUGES

The onscreen volume gauge can also be used to adjust system volume:

- 1) Tap [Title Bar](#) at the top of the screen.
A horizontal drop-down bar opens.
- 2) Tap the volume icon .

[Volume] dialog opens presenting the gauges for system volume and phone ringer volume. Two radio buttons [On] and [Off] are featured on the right. Select [On] or [Off] to enable or mute both volumes.

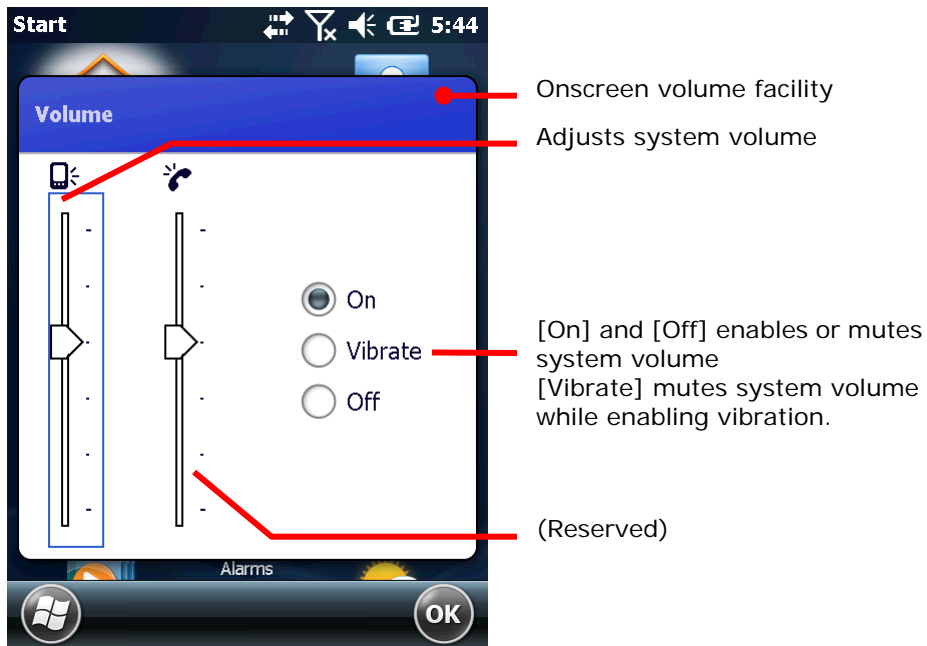

3) Adjust the settings to meet your needs.

DATA CAPTURE

Although highly converged, the mobile computer is also a dedicated barcode reader. The mobile computer is shipped with either a (laser) 1D reader or 2D imager. A number of symbologies are supported and data about them can be decoded and collected.

Done with data collection, the mobile computer outputs the collected data to the host computer so data storage, advanced data analysis and more special services can be performed.

This chapter describes how to collect data with reader modules.

Note: The mobile computer allows three forms of data capturing, either by laser scanning, 2D imaging or capturing colored images via the digital camera. Laser scanning and imaging are described in this chapter. For digital camera usage, see [Camera](#).

2. IN THIS CHAPTER

2.1 Configure Reader	62
2.2 Launch Reader	78
2.3 Read Printed Barcodes.....	79

2.1. CONFIGURE READER

The mobile computer is capable of reading printed barcodes. The reader module can be either a (laser) 1D reader or a 2D imager. The mobile computer is installed with a CipherLab utility **Reader Config** to configure the scan engine built inside. Use it to create a profile of settings that best suits your needs.

2.1.1. LAUNCH READER CONFIG

To launch Reader Config:

- 1) On Start screen, tap **Settings | System | Reader Configuration** .

Reader Config launches in context with the reader module(s) on board the mobile computer. On the main settings page are three sections: **General Settings**, **Symbology** and **Miscellaneous**.

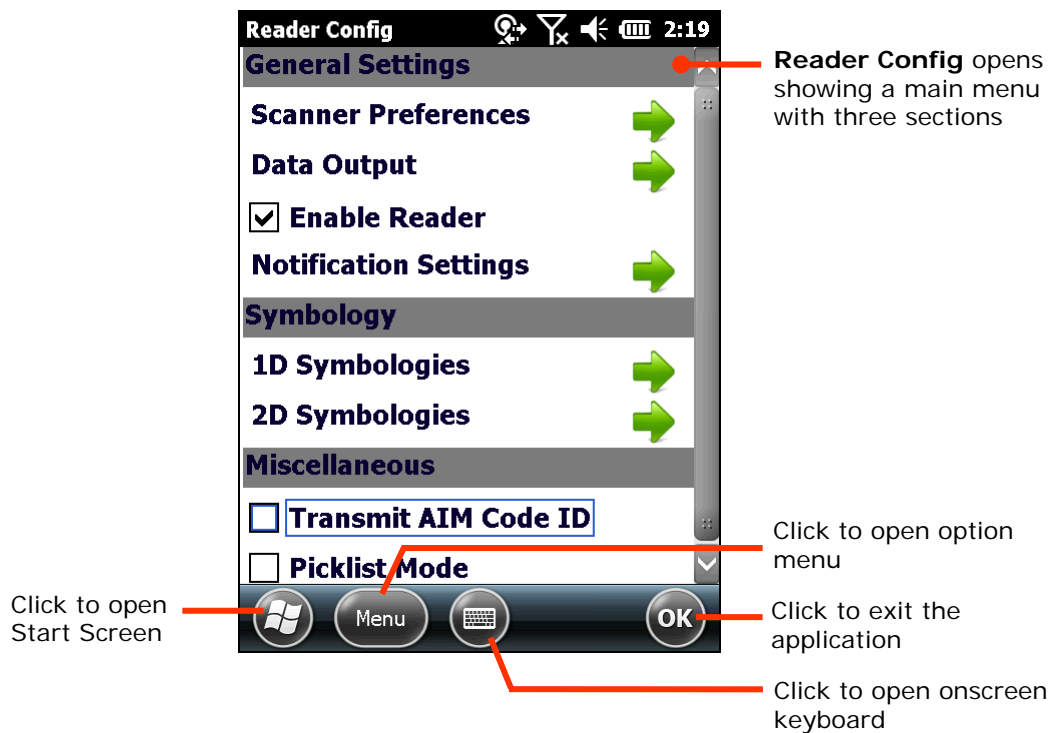

The following will guide to settings provided in each of the three sections.

2.1.2. GENERAL SETTINGS

General Settings is where all reader settings are accessed from except for symbologies settings. Tap the green arrow next to each item to enter the sub-menu for that given item.

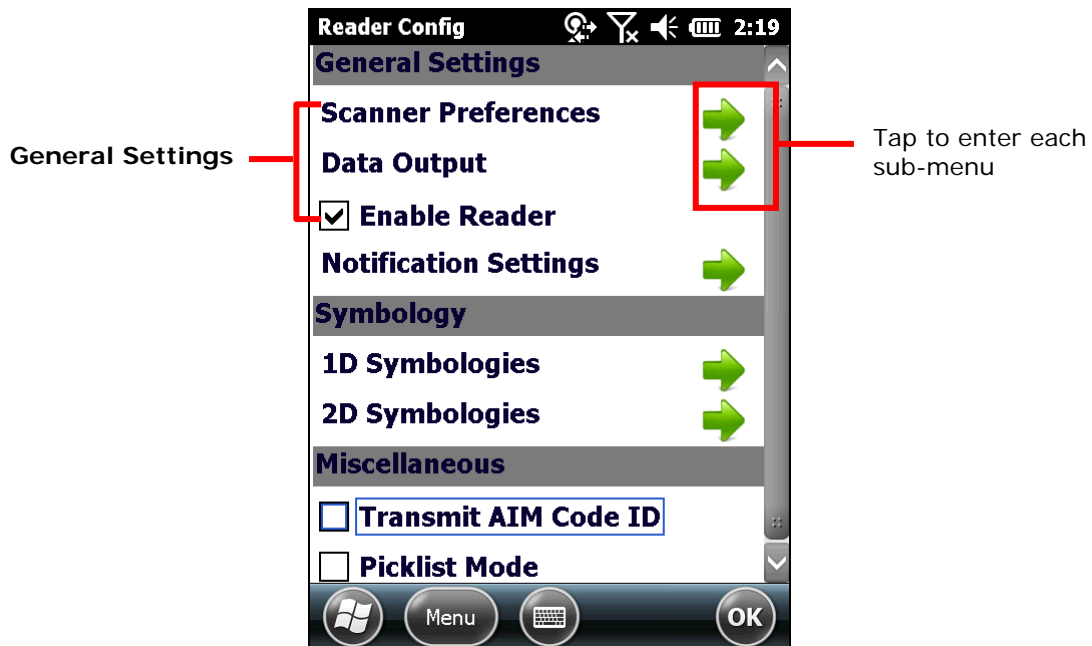

The functions under **General Settings** include:

- ▶ Scanner Preferences
- ▶ Data Output
- ▶ Enable Reader - enabled by default
- ▶ Notification Settings

SCANNER PREFERENCES

Scanner Preferences page can be entered by tapping the given item on the **Reader Config** main settings page. The options provided in this page differ according to the type of scan engine (either 1D or 2D) built within the mobile computer.

To open **Scanner Preferences** page:

- 1) Open **Reader Config** as described in [Launch Reader Config](#).
Reader Config settings page opens.
- 2) Tap the arrow next to **Scanner Preferences**.
Scanner Preferences settings page opens.

Featured settings are different for 1D (laser) reader and 2D imager:

1D (laser) reader settings

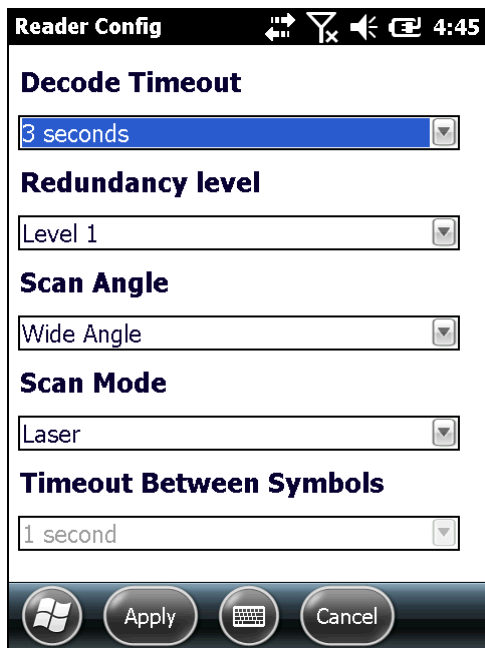

2D imager settings

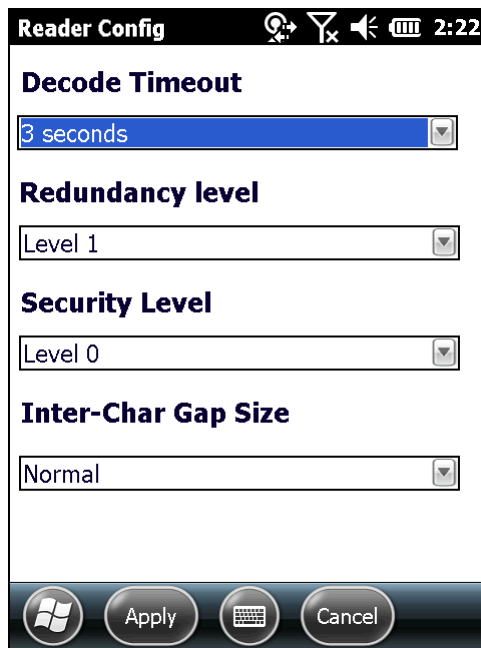

1D (LASER) READER SETTINGS

Setting	Description	Default
Decode Timeout	Sets the maximum time for the decoding process during a scan. Configurable between 1 sec to 9 sec.	3 sec
Redundancy Level	Sets how many successful readings should be done before linear barcodes such as Codabar, MSI, and Interleaved 2 of 5 can be decoded. Levels 1 to 4 available.	Level 1
Scan Angle	Sets the scan angle for laser scan engine. Options to choose between are Wide Angle and Narrow Angle .	Wide Angle
Scan Mode	Sets the reader's scanning behaviour. Options available are Continuous and Laser modes.	Laser
Timeout Between Symbols	Sets the time for the barcode reader to resurrect its ability to once more decode a barcode it just decoded. ▶ Only applied in Continuous mode.	1 sec

2D IMAGER SETTINGS

Setting	Description	Default										
Decode Timeout	Sets the maximum time for the decoding process during a scan. Configurable between 1 sec to 9 sec.	3 sec.										
Redundancy Level	Sets how many successful readings should be done before linear barcodes such as Codabar, MSI, and Interleaved 2 of 5 can be decoded. Levels 1 to 4 available.	Level 1										
Security Level	<p>Sets the security level to ensure decoding accuracy considering the printed quality of barcodes such as Code 128, Code 93, and UPC/EAN. The higher the level is, the more security is ensured. Options are:</p> <table border="1"> <thead> <tr> <th>Level</th> <th>Description</th> </tr> </thead> <tbody> <tr> <td>0</td> <td>With this default, the scan engine is aggressive enough to decode most "in-spec" barcodes.</td> </tr> <tr> <td>1</td> <td>Select this level if misdecodes have occurred. It fixes most misdecodes.</td> </tr> <tr> <td>2</td> <td>Select this level if Level 1 should fail to eliminate misdecodes.</td> </tr> <tr> <td>3</td> <td>Select this level if Security Level 2 should fail to prevent misdecodes. However, as this level actually impairs the decoding ability of the decoder, a safer solution would be to improve the quality of the bar codes to read.</td> </tr> </tbody> </table>	Level	Description	0	With this default, the scan engine is aggressive enough to decode most "in-spec" barcodes.	1	Select this level if misdecodes have occurred. It fixes most misdecodes.	2	Select this level if Level 1 should fail to eliminate misdecodes.	3	Select this level if Security Level 2 should fail to prevent misdecodes. However, as this level actually impairs the decoding ability of the decoder, a safer solution would be to improve the quality of the bar codes to read.	Level 0
Level	Description											
0	With this default, the scan engine is aggressive enough to decode most "in-spec" barcodes.											
1	Select this level if misdecodes have occurred. It fixes most misdecodes.											
2	Select this level if Level 1 should fail to eliminate misdecodes.											
3	Select this level if Security Level 2 should fail to prevent misdecodes. However, as this level actually impairs the decoding ability of the decoder, a safer solution would be to improve the quality of the bar codes to read.											
Inter-Char Gap Size	Sets the intercharacter gap size for Code 39 and Codabar. Switch between Normal and Large .	Normal										

DATA OUTPUT

Data Output allows users to set the way to output decoded data.

To open **Data Output** settings page:

- 1) Open **Reader Config** as described in [Launch Reader Config](#).
Reader Config main menu opens.
- 2) Tap the arrow next to **Data Output**.

Data Output settings page opens.

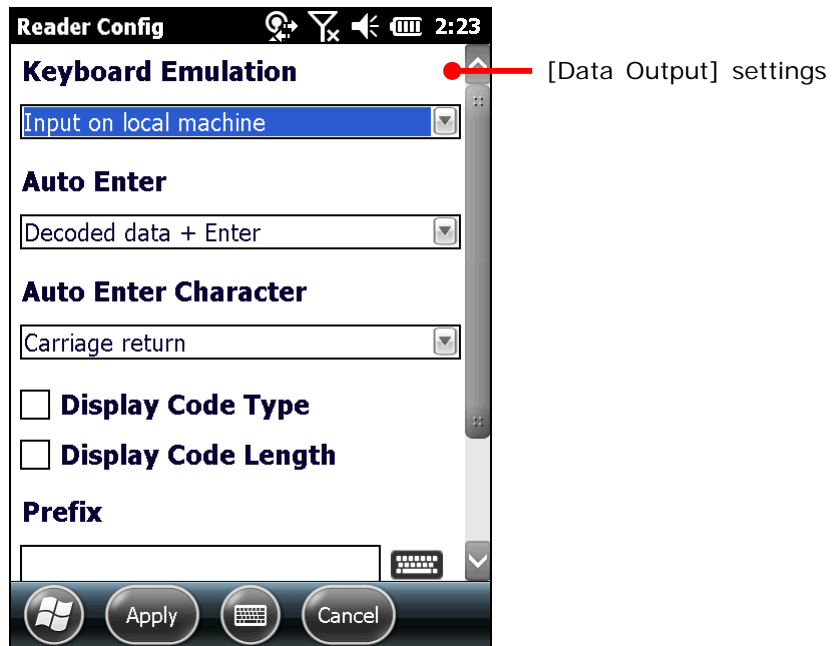



WHERE TO OUTPUT

Keyboard Emulation setting controls where the decoded data is to be output.

Setting	Descriptions	Default
Keyboard Emulation	<p>Treats decoded data as typed text and outputs it to the active application locally on the mobile computer or remotely on a computer. Options are:</p> <ul style="list-style-type: none"> ▶ Disable – Disables Keyboard emulation whereby decoded data won't be output. ▶ Input on local machine – Passes decoded data locally to the active application on the mobile computer. Simply run an application such as Wordpad to collect decoded data. ▶ Input on remote PC – Passes decoded data to the active application on the remote computer connected. Set up a remote PC connection to collect data. (Note this option is unable to pass double-byte characters such as Big-5 or Unicode characters.) 	Input on local machine

HOW TO OUTPUT

After the output destination is set, configure how to output decoded data, i.e. the “format” to present decoded data.

Setting	Description	Default
Auto Enter	<p>Adds an ENTER character before or after each scanning act. This function saves the trouble pressing [Enter] key to confirm each scan. Options are:</p> <ul style="list-style-type: none"> ▶ Disable ▶ Decoded data + Enter ▶ Enter + Decoded data 	Decoded data + Enter
Auto Enter character	<p>Adds a key code before or after the decoded data. This setting is available only when [Auto Enter] is enabled. Options are:</p> <ul style="list-style-type: none"> ▶ None ▶ Carriage Return ▶ Tab ▶ Space ▶ Comma ▶ Semicolon 	Carriage Return
Display Code Type	Prefixes the output data with code type information.	Deselected (Disabled)
Show Code Length	Suffixes the output data with code length information.	Deselected (Disabled)
Prefix	<p>Affixes 0 to 10 characters to the left of the output data. Tap the keyboard icon  next to the input field to open a character table for entering the prefix.</p> <ul style="list-style-type: none"> ▶ Prefixes containing invisible characters are supported. 	--
Suffix	<p>Affixes 0 to 10 characters to the right of the output data. Tap the keyboard icon  next to the input field to open a character table for entering the suffix.</p> <ul style="list-style-type: none"> ▶ Suffixes containing invisible characters are supported. 	--

ENABLE READER

Features a checkbox to enable or disable reader scanning ability. When enabled, light beam will be sent out each time the trigger (scan key) is pressed.

NOTIFICATION SETTINGS

Notification Settings enables audible, visible and tactile feedback for scanning good read, which helps notify the user of a successful decoding.

To open **Notification Settings** page:

- 1) Open **Reader Config** as described in [Launch Reader Config](#).

Reader Config main menu opens.

- 2) Tap the arrow next to **Notification Settings**.

Notification Settings page opens.

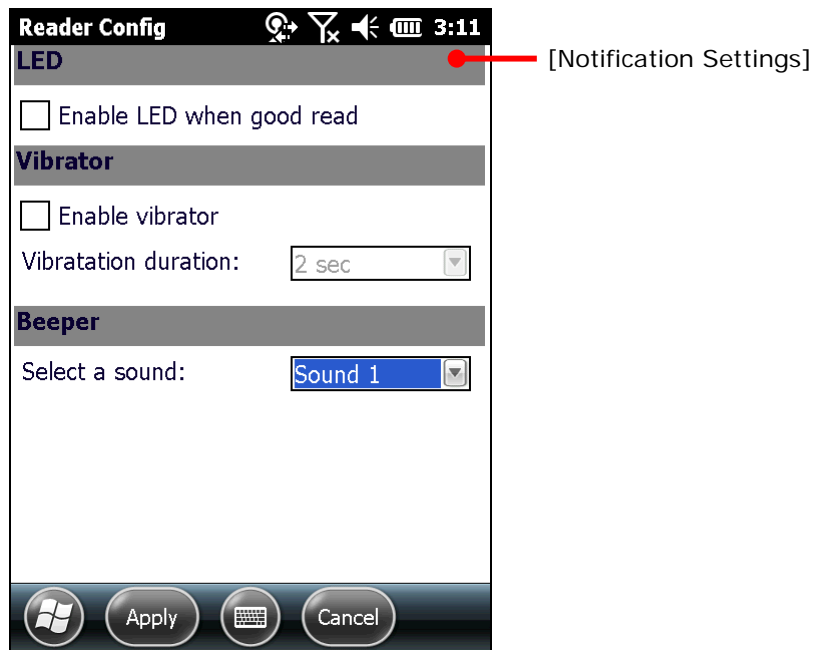

Setting		Description	Default
LED	Enable LED when good read	Selects to enable/disable LED light (left) for scanning good read. See Status LED for details.	Deselected (Disabled)
Vibrator	Enable vibrator	Enables/disables tactile feedback (vibration) for good read.	Deselected (Disabled)
	Vibration duration	Sets the duration for tactile feedback (vibration).	--
Beeper	Select a sound	Sets the beeper sound for scanning good read. Users can choose to mute the beeper sound, or configure the beeper between sounds 1 to 9.	Sound 1

2.1.3. SYMBOLOGY

Symbology section sets the symbologies to read, and also enables/disables some feature(s) for a symbology to read, such as:

- ▶ Customize and transmit start/stop characters
- ▶ Verify/transmit check digits,
- ▶ Enable/disable addon digits
- ▶ Convert to another symbology
- ▶ Transmit symbology ID

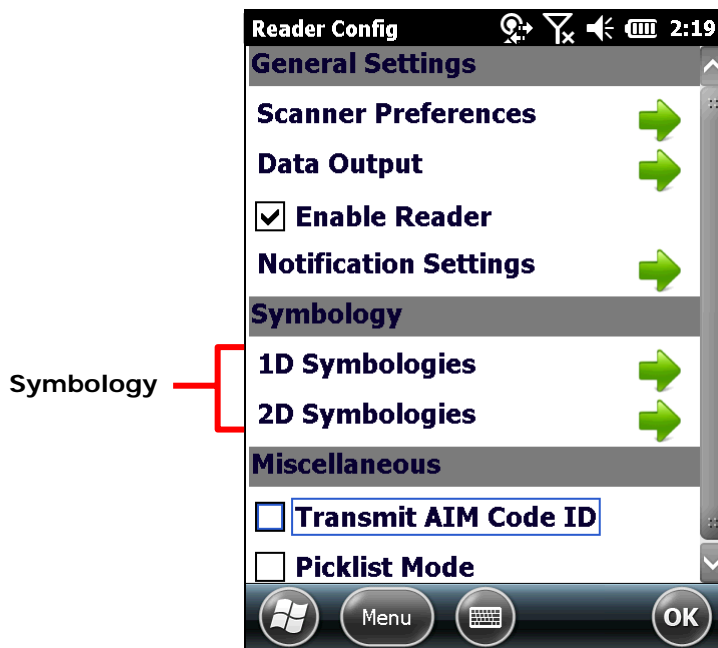

To open **Symbology** settings page:

- 1) Open **Reader Config** as described in [Launch Reader Config](#).
Reader Config main menu opens.
- 2) Tap the arrow next to **1D Symbologies** (or **2D Symbologies** in the case of a 2D imager).

Symbology settings page opens listing all symbologies which can be decoded.

1D Symbologies

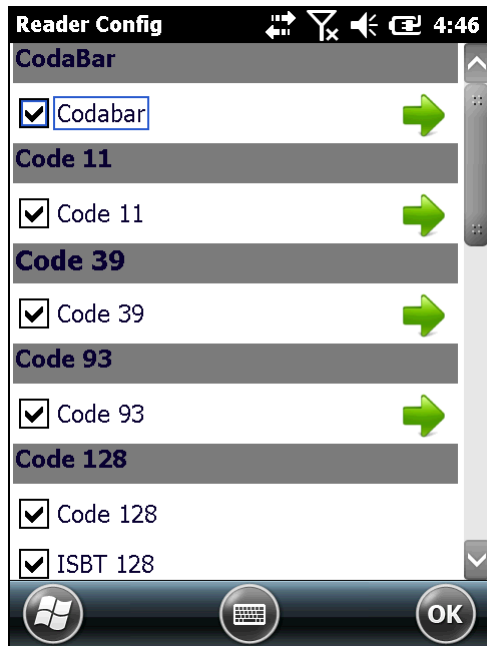

2D Symbologies

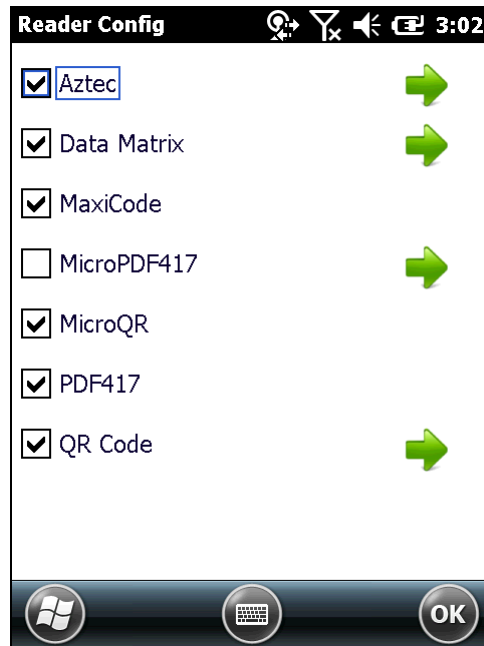

SYMBOLGY SETTINGS

Tap the arrow next to each symbology checkbox to access detailed settings for that symbology.

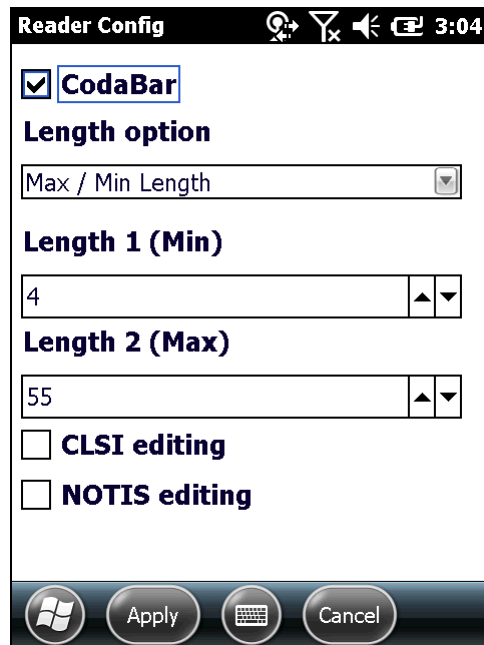
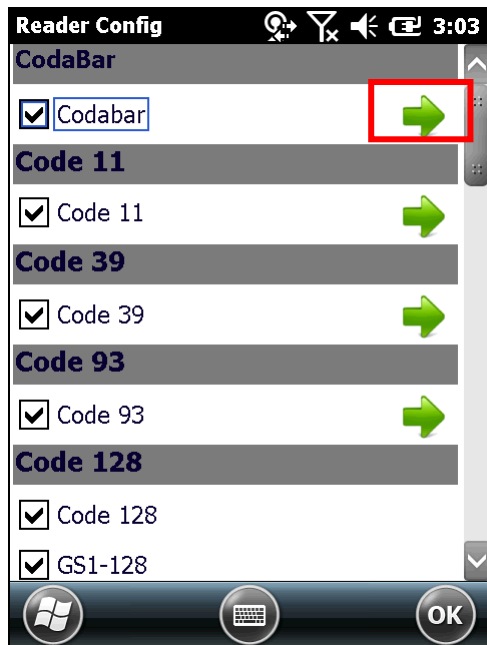

GENERAL PREFERENCES

For certain symbologies, common settings are grouped together and displayed in a detailed settings page for that barcode family. To open the general settings page for a set of symbologies, tap the arrow next to **General Preference**.

General settings are provided for Composite Code, Postal Code, and UPC/EAN families.

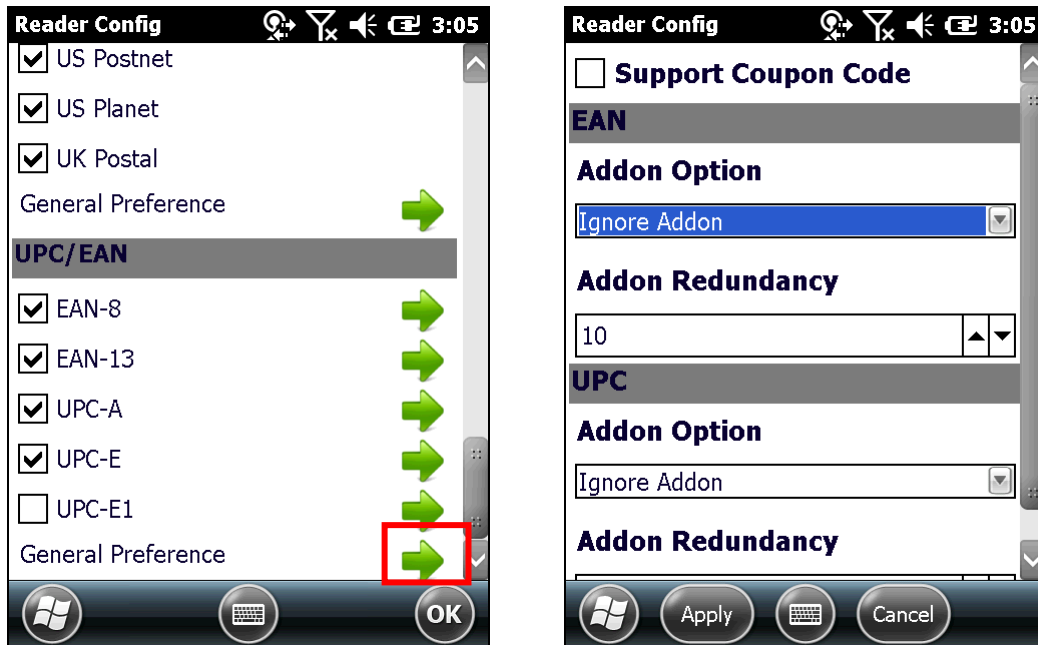

For details about the featured settings:

- ▶ See Appendix II: 1D Laser [Symbology Settings](#).
- ▶ See Appendix III: 2D Imager [Symbology Settings](#).

2.1.4. MISCELLANEOUS

This section allows enabling code ID transmission for easy identification of the scanned barcode, and enabling picklist mode to enhance decoding accuracy.

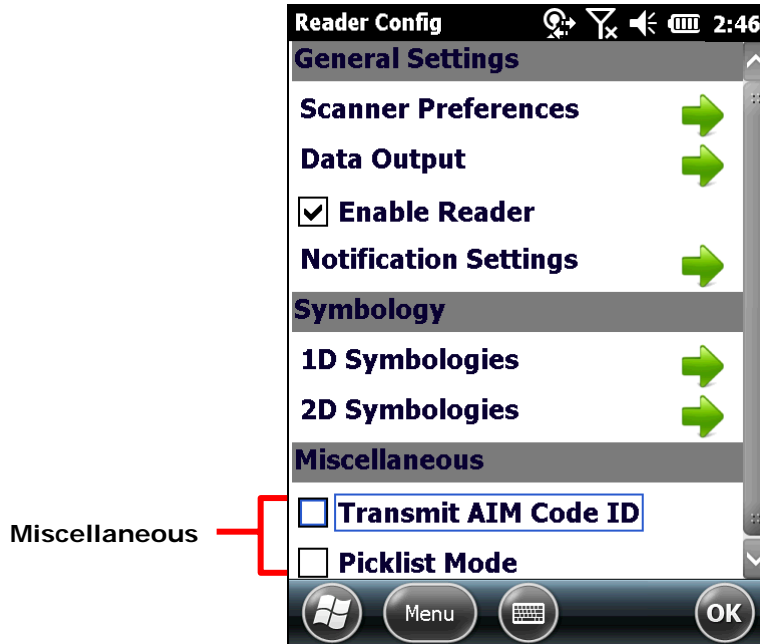

Setting	Description	Default
Transmit AIM Code ID	Sets whether to include AIM code ID character in the decoded data. For AIM code ID, see the following: <ul style="list-style-type: none"> ▶ Appendix II: 1D Laser Symbology Settings ▶ Appendix III: 2D Imager Symbology Settings 	Deselected (Disabled)
Picklist Mode (Available on 2D imager only)	Sets whether to enable picklist mode in which only barcodes aligned at the crosshair of the scanner beam will be decoded.	Deselected (Disabled)

2.1.5. READER CONFIG OPTION MENU

Reader Config provides an option menu which is accessible on the main settings page and provides options to import/export all settings in a re-usable format, reset all settings back to factory default, view copyright and version information, and exit the application.

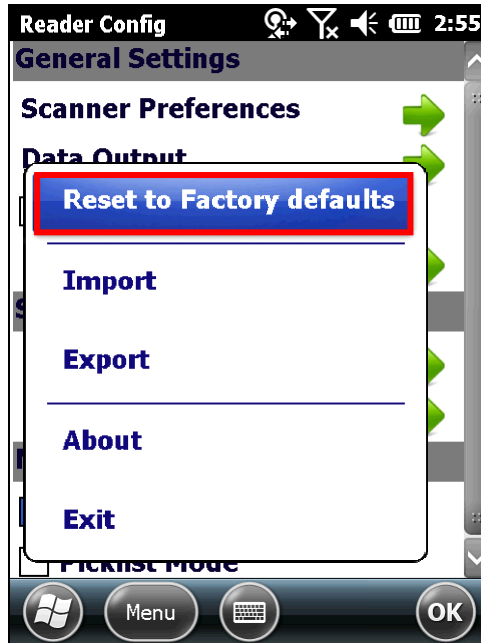
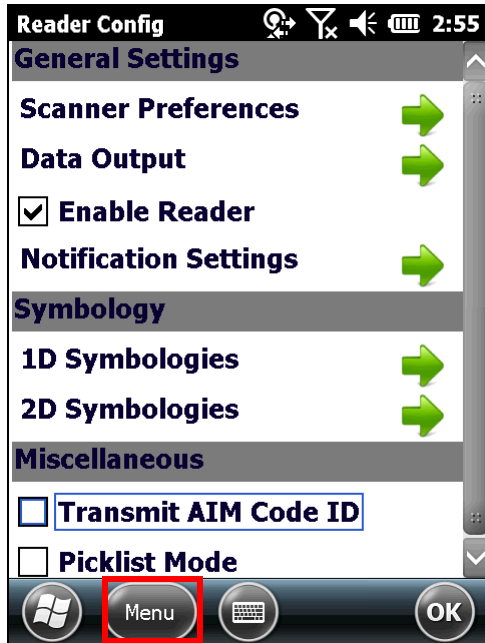

RESET TO FACTORY DEFAULTS

This function restores all settings in the **Reader Config** application to default.

To enable Factory Reset:

- 1) Open **Reader Config** as described in [Launch Reader Config](#).
Reader Config main menu opens.
- 2) Tap **Menu** button on the softkey bar to open the option menu.
- 3) Tap **Reset to Factory defaults**.
- 4) A warning dialog appears confirming whether to restore all application settings back to default. Tap **Yes** to reset or **No** to close the dialog.

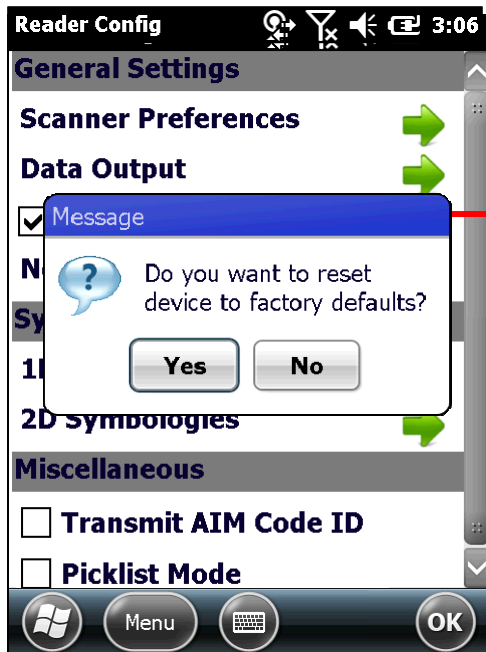

A warning dialog pops up to confirm if reset should be performed

IMPORT AND EXPORT

Reader Config supports saving the settings and exporting them as an .xml file.

Previously exported symbology and scanner settings can be imported again on the mobile computer. This can also be used to implement identical Reader Config settings on two or more devices.

To import settings:

- 1) Open **Reader Config** as described in [Launch Reader Config](#).

Reader Config main menu opens.

- 2) Tap **Menu** button on the softkey bar to open the option menu.
- 3) Tap **Import** in the option menu.

A page opens allowing you to select a previously saved profile.

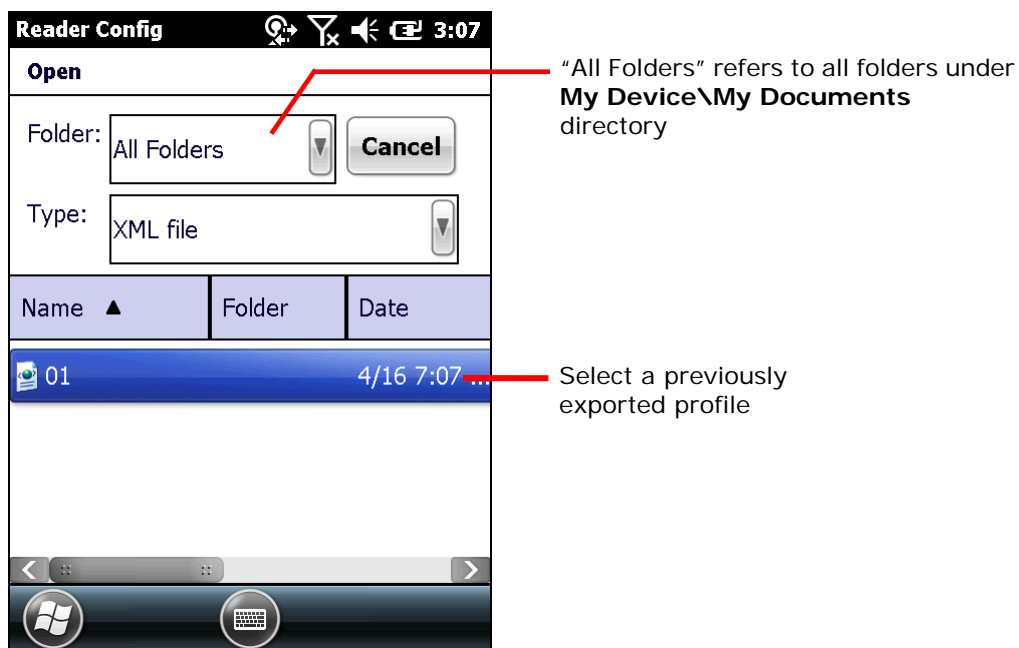

- 4) Tap on the profile you would like to apply. In a few seconds a prompt will appear on the mobile computer to indicate settings have been imported successfully.

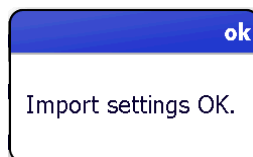

To export settings:

- 1) Open **Reader Config** as described in [Launch Reader Config](#).
Reader Config main menu opens.
- 2) Tap **Menu** button on the softkey bar to open the option menu.
- 3) Tap **Export**.

An export page opens allowing you to enter and select information about the profile to be saved.

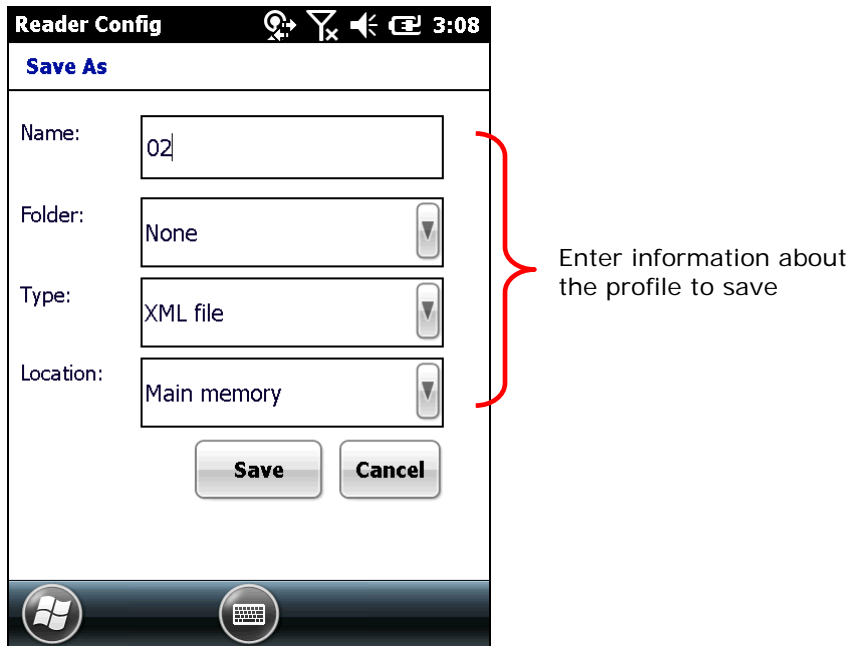

- 4) Enter file name, storage folder and location. Tap **Save** to export. A prompt will appear onscreen to notify that settings have been exported.

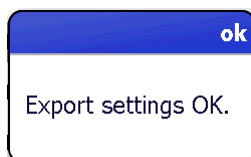

Note: The **All Folders** directory refers to all folders under **My Device\My Documents**. If no subfolder is selected upon export, the exported file will be stored directly under this directory.

ABOUT

This item in the Reader Config option menu delivers software version and copyright information.

To view information about the software:

- 1) Open **Reader Config** as described in [Launch Reader Config](#).
Reader Config main menu opens.
- 2) Tap **Menu** button on the softkey bar to open the option menu.
- 3) Tap **About**.

Information about the software will be displayed onscreen.

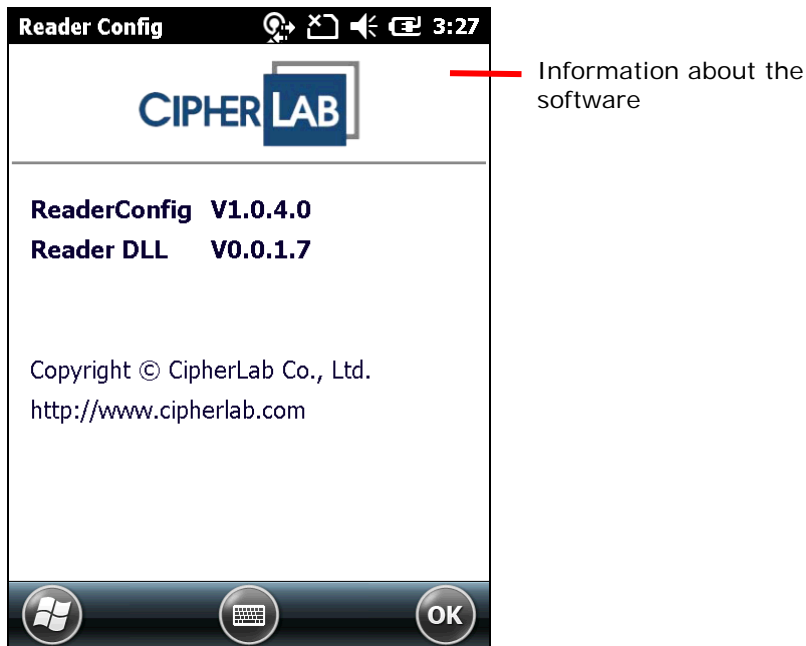

2.2. LAUNCH READER DEMO

Aside from output to destinations as per [Keyboard Emulation](#) settings, decoded data can also be displayed using the pre-installed CipherLab utility **Reader Demo**.

To launch **Reader Demo**:

- 1) Configure scan engine properties as described in [Configure Reader](#).
- 2) Open Start screen, tap **CipherLabUtilities** .
- 3) Tap **Reader Demo** .

ReaderDemo opens displaying two fields to show the decoded data.

The mobile computer is now ready to read printed barcodes.

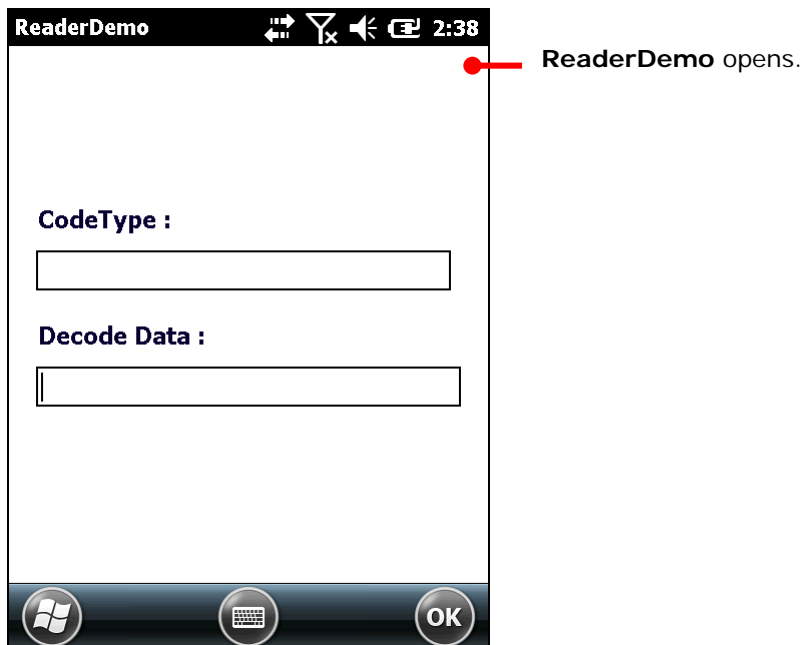

- 4) Proceed to collect data as described in [Read Printed Barcodes](#).

OR

If you want to, configure the reader module(s) first as described in [Configure Reader](#) before starting to collect data.

2.3. READ PRINTED BARCODES

Before you start collecting data, configure the reader module(s) using **Reader Config** as described in [Configure Reader](#) or skip the configuration and go straight to collect data using **Reader Demo**.

To collect data:

- 1) Use **Reader Config** to configure the reader module as described in [Configure Reader](#).
- 2) Launch the scanning utility **Reader Demo** as described in [Launch Reader Demo](#).

The provided application **Reader Demo** displays the barcode which was last decoded. If you would like to collect more or all of the decoded data for further use, enable [Keyboard Emulation](#) and run a text editor on the mobile computer or connect the mobile computer to a remote computer so there is somewhere to admit the decoded data.

- 3) Locate the scanning window on the top of the mobile computer. Point it at the printed barcode to read while holding the mobile computer steady a few inches from the barcode.
- 4) Press the scan key (or either side trigger) on the mobile computer.

The scanning light beams to read the printed barcodes.

The scanning light goes off once data is decoded, or decoding timeout is reached.

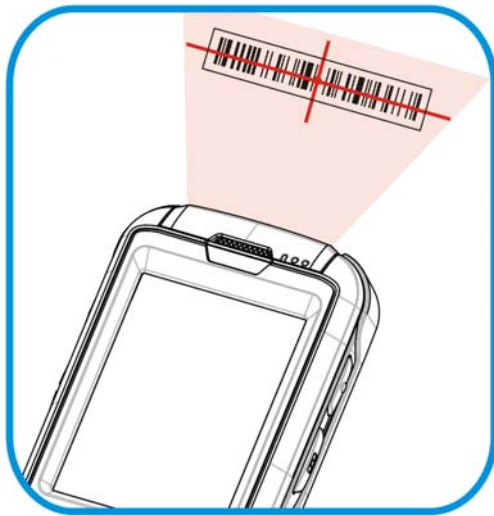

Figure 14: Read printed barcodes

- 5) The decoded data will display in **Reader Demo**, or display in the target destination as configured in **Reader Config**.

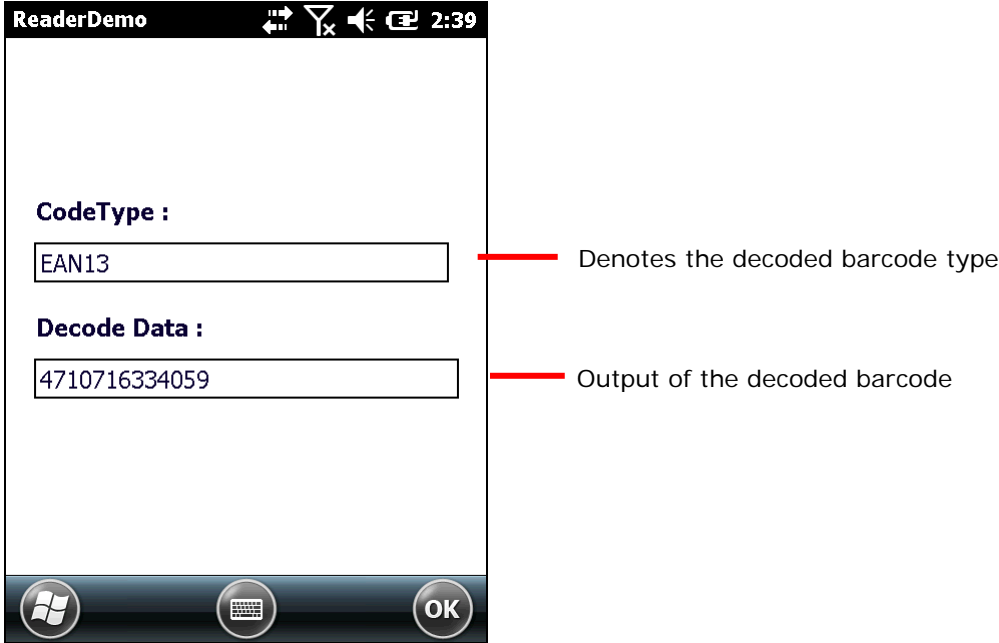

Figure 15: Reading Printed Barcodes

CAMERA

The mobile computer is adorned with a 5.0 mega-pixel camera that can also serve as a video recorder. The OS provides a camera/video recorder application, which launches the camera, takes pictures, shoots videos and stores the works on the mobile computer's storage where they can be viewed, edited and output.

The camera/video recorder application provides users with satisfactory customization that is helpful for users' image capture for better documentation.

This chapter will guide you to use the camera.

Note: When the camera is active, the 2D imager will be temporarily out of service. To re-launch the reader module, close the camera application.

3. IN THIS CHAPTER

3.1 Launch Camera	82
3.2 Take Pictures	83
3.3 Launch Video Camera	86
3.4 Shoot Videos.....	87
3.5 Pictures & Videos.....	89

3.1. LAUNCH CAMERA

To launch the camera:

- 1) On Start screen, tap **Pictures and Videos** .
Pictures and Videos application opens.
- 2) Tap **Camera** icon located at the upper left of the window.
Camera opens in portrait mode and readies to take pictures.

3.1.1. CAMERA SCREEN

Camera opens showing subject area on the screen with related information displayed in the lower right corner. A menu bar sitting on the bottom allows users to switch to thumbnail display under **Pictures & Videos**, adjust camera settings, switch to video shooting mode, exit the camera tool and more.

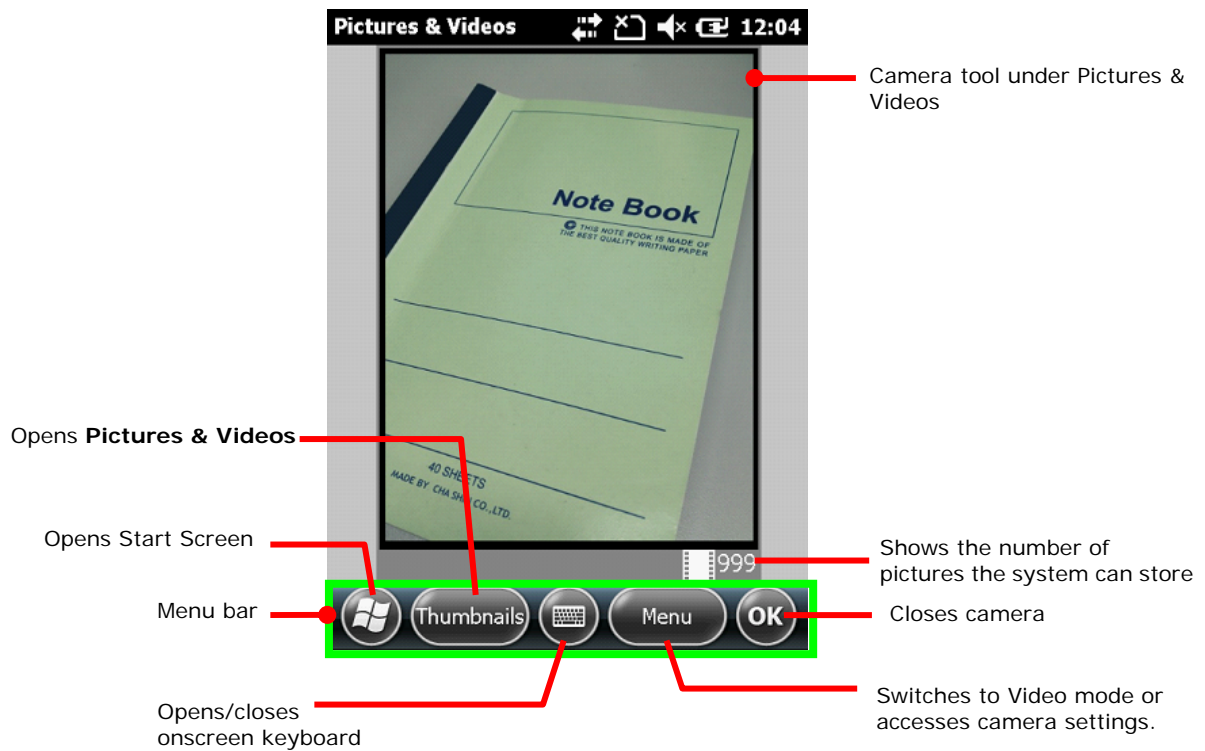

3.2. TAKE PICTURES

By default, pictures are taken in JPEG format and are saved to the mobile computer's internal storage under **My Device\My Documents\My Pictures**. To change the default storage path, see [Camera Settings](#).

To take a picture:

- 1) Open camera as described in [Launch Camera](#).
Camera opens in portrait mode and readies to take pictures.
- 2) Enable/disable camera flash and adjust picture quality or other settings according to your preferences. See [Camera Settings](#).
- 3) Frame your object on the screen.
- 4) Press the Enter button on the keypad to take the picture.

After the picture is taken, a preview of it will appear briefly on the screen.

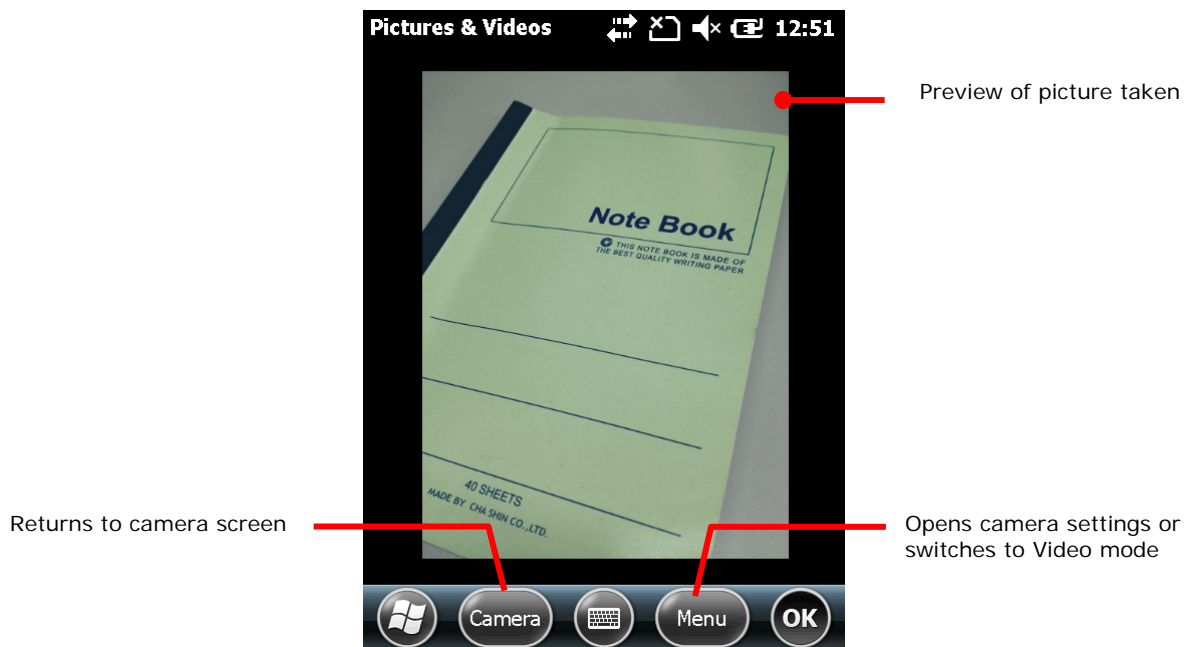

By default, pictures taken will be stored under **My Device\My Documents\My Pictures** in imgxxx.jpg format.

3.2.1. CAMERA SETTINGS

The camera supports changing shooting mode, brightness and resolution. Users can also enable full screen shooting mode which leaves the screen clean of option buttons and picture information.

To access camera settings:

- 1) Open camera as described in [Launch Camera](#)..
- 2) Tap **Menu** command on the softkey bar

A pop-up option menu appears onscreen showing various option settings.

- 3) Note: The **Menu** command and pop-up option menu are also available in the picture preview screen.

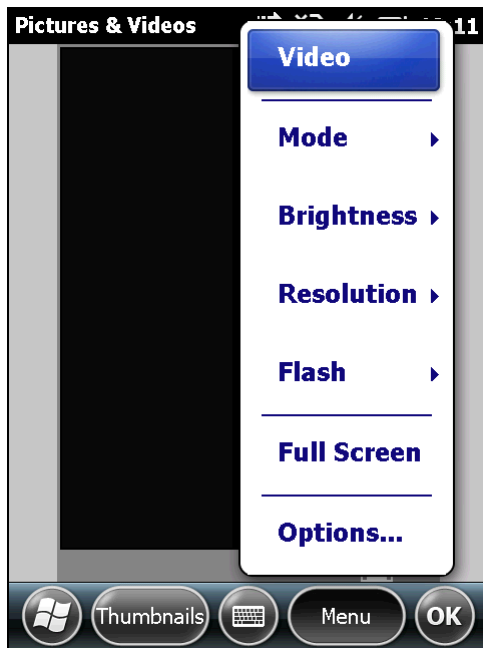

Available menu items are detailed as below:

Item	Description
Video	Switch to video camera.
Mode	Sets camera mode between Normal, Burst or Timer.
Brightness	Sets the brightness between -3 to +3 in increments of 1.
Resolution	The mobile computer supports the following resolutions: 240x320, 480x640, 960x1280, 1200x1600, 1536x2048, 1944x2592.
Flash	Switch flash on or off.
Full Screen	Switches to full screen mode (all menu buttons will be hidden). Tap screen to quit this mode.

Options...

Opens **Pictures & Videos** settings page showing four tabbed pages: **Camera**, **Video**, **General**, and **Slide Show**.

Camera tabbed page:

Sets the file prefix, storage destination and compression level of the stored image.

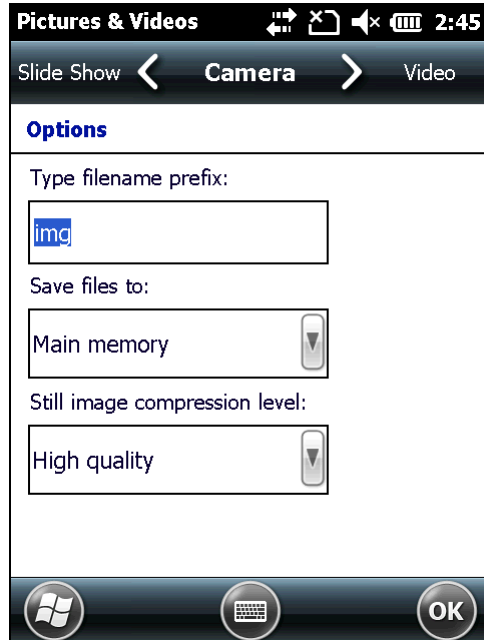
**Video** tabbed page:

Selects whether to include audio data when recording videos, and the time limit for recording.

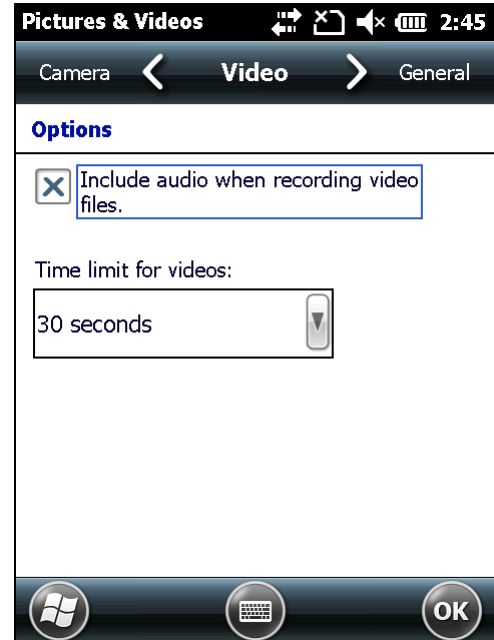
**General** tabbed page:

Select between the size of the image file to send via e-mail, and the direction to rotate pictures.

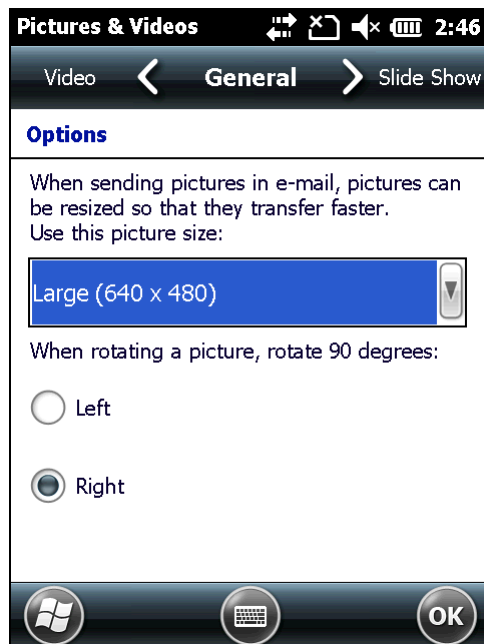
**Slide Show** tabbed page:

Select how to display pictures during slideshow, and whether to play PC's screensaver on mobile computer after certain idle time (mobile computer must be connected to PC).

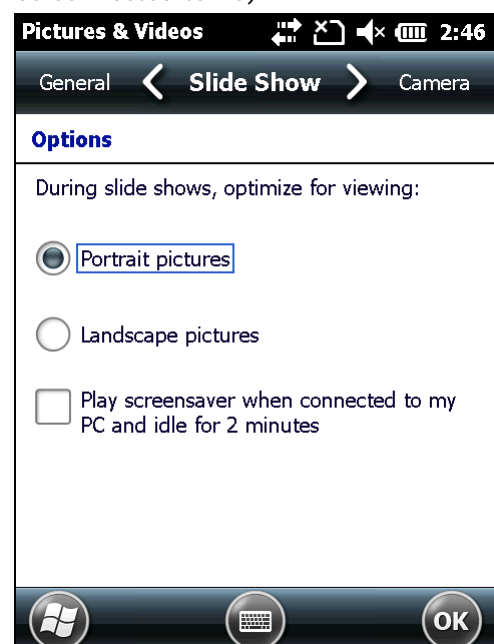

3.3. LAUNCH VIDEO CAMERA

To launch the video camera:

- 1) Launch camera as described in [Launch Camera](#).
- 2) Tap **Menu** command on the softkey bar
- 3) Tap **Video** in the option menu.

Video camera is readied to begin shooting.

3.3.1. VIDEO CAMERA SCREEN

Video camera launches showing subject area onscreen with the remaining recording time displayed in the lower right corner. A menu bar sitting on the bottom allows users to switch to thumbnail display under **Pictures & Videos**, adjust camera settings, switch to picture taking mode, exit the camera tool and more.

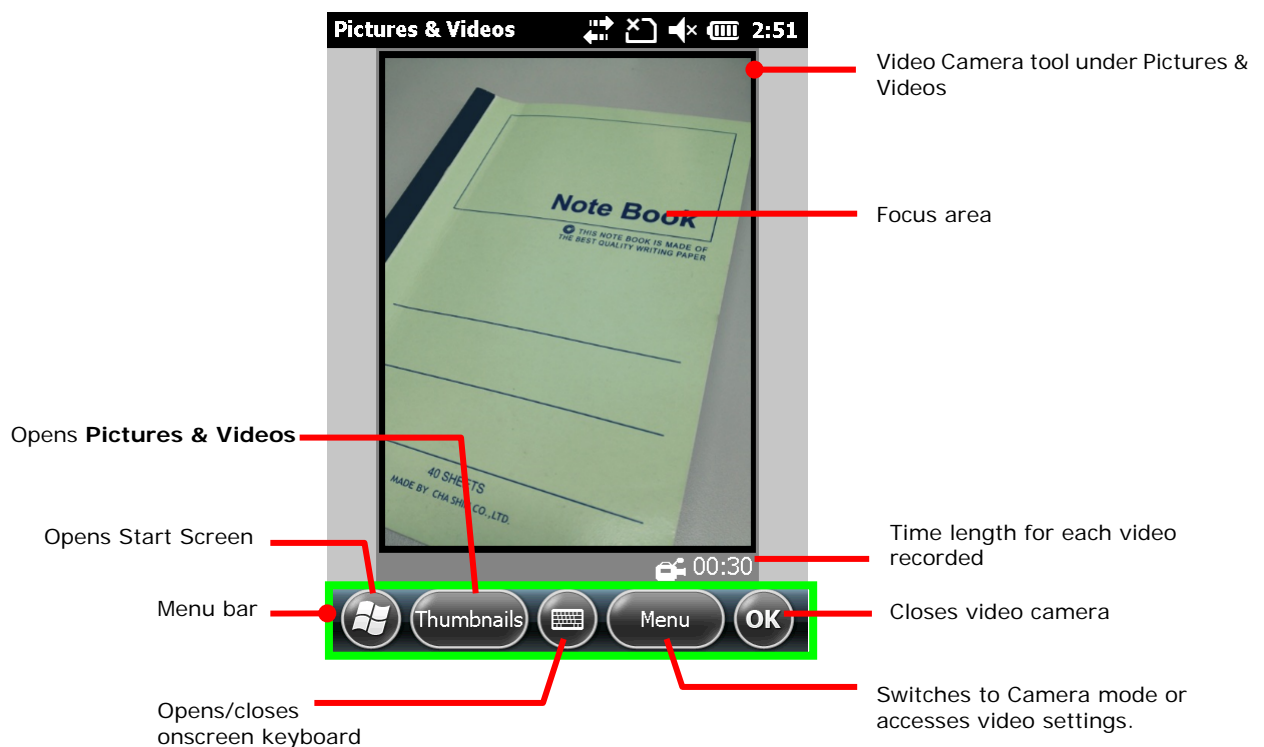

3.4. SHOOT VIDEOS

By default, videos are shot in WMV format and are saved to the mobile computer's internal storage under **My Device\My Documents\My Pictures**. To change the default storage path, see [Camera Settings](#).

To shoot a video:

- 1) Open video camera as described in [Launch Camera](#).
Video camera opens in portrait mode and readies to shoot.
- 2) Adjust brightness and other settings according to your preferences. See [Camera Settings](#).
- 3) Frame your object on the screen.
- 4) Press the Enter button on the keypad

The video then starts shooting, and two time meters located respectively on the lower left and right will show the shooting time and the remaining time allowed for shooting the video.

Press the Enter button once more to end shooting.

Note: The allowed video shooting length can be adjusted in **Video** tabbed page under **Pictures & Video** settings. See [Camera Settings](#) for more details.

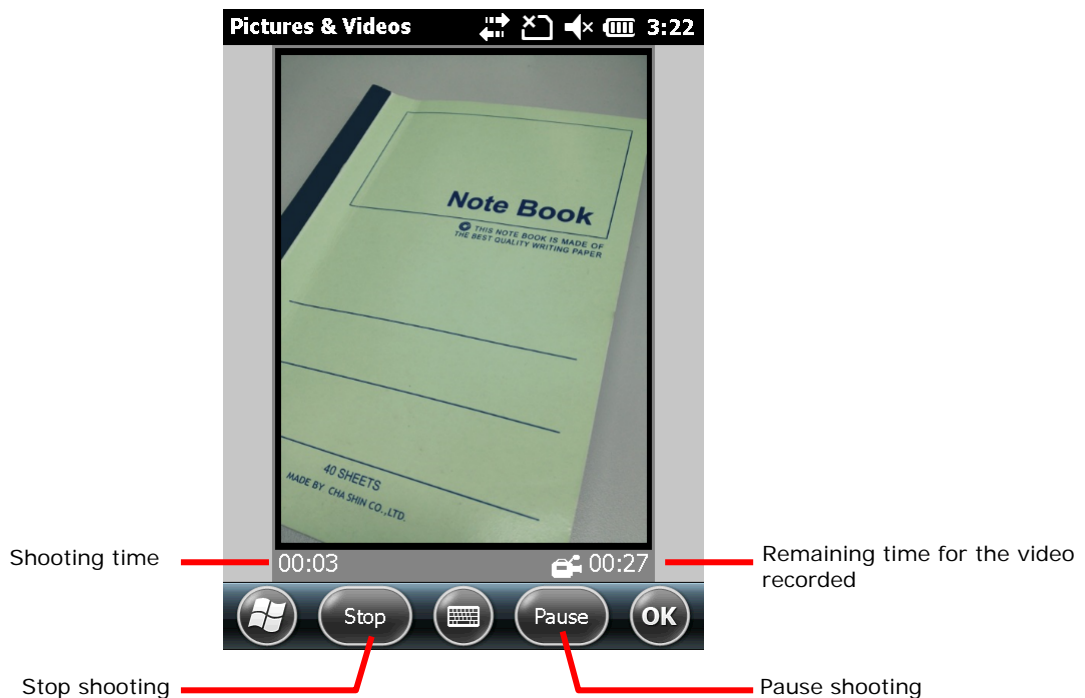

By default, videos shot will be stored under **Mobile Device\My Documents\My Pictures** in xxx.wmv format.

3.4.1. VIDEO CAMERA SETTINGS

The video camera supports changing brightness and quality. Users can also enable full screen shooting mode which leaves the screen clean of option buttons and picture information.

To access video camera settings:

- 1) Open video camera as described in [Launch Video Camera](#).
- 2) Tap **Menu** command on the softkey bar

A pop-up option menu appears onscreen showing various option settings.

Note: The **Menu** command and pop-up option menu are also available in the video preview screen.

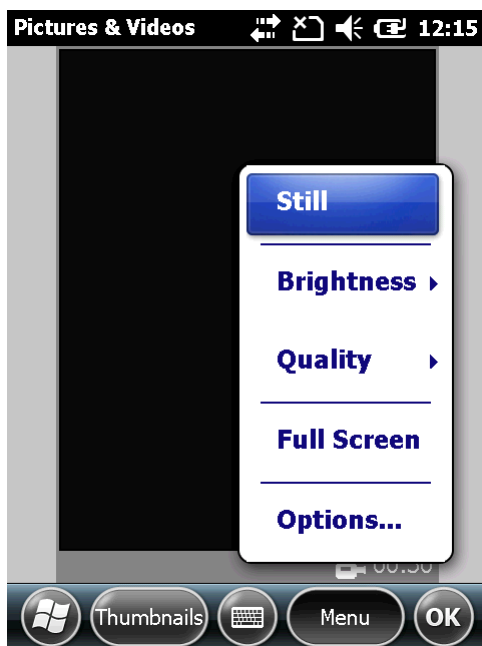

- 3) Available menu items are detailed as below:

Item	Description
Still	Switch to camera.
Brightness	Sets the brightness between -3 to +3 in increments of 1.
Quality	The mobile computer supports 240x320 resolution for video recording
Full Screen	Switches to full screen mode (all menu buttons will be hidden). Tap screen to quit this mode.
Options...	Opens Pictures & Videos settings page showing four tabbed pages: Video , General , Slide Show and Camera . These are the same as described in Camera Settings .

3.5. PICTURES & VIDEOS

Pictures & Videos is an application that views and edits the pictures taken and videos shoot, or those copied or downloaded. It also sets background for [Today Screen](#) and [Start Screen](#), and sets avatars for your contacts. It can also be used to email pictures and videos.

LAUNCH PICTURES & VIDEOS

To launch Pictures & Videos:

- 1) On Start screen, tap **Pictures & Videos** icon .

OR

Tap **Thumbnails** command on camera or video recorder menu bar if it is active at the moment.

Pictures & Videos opens unfolding **My Device\My Documents\My Pictures**, the default folder that stores the pictures and videos copied/downloaded from external resources or taken/recorded on the mobile computer.

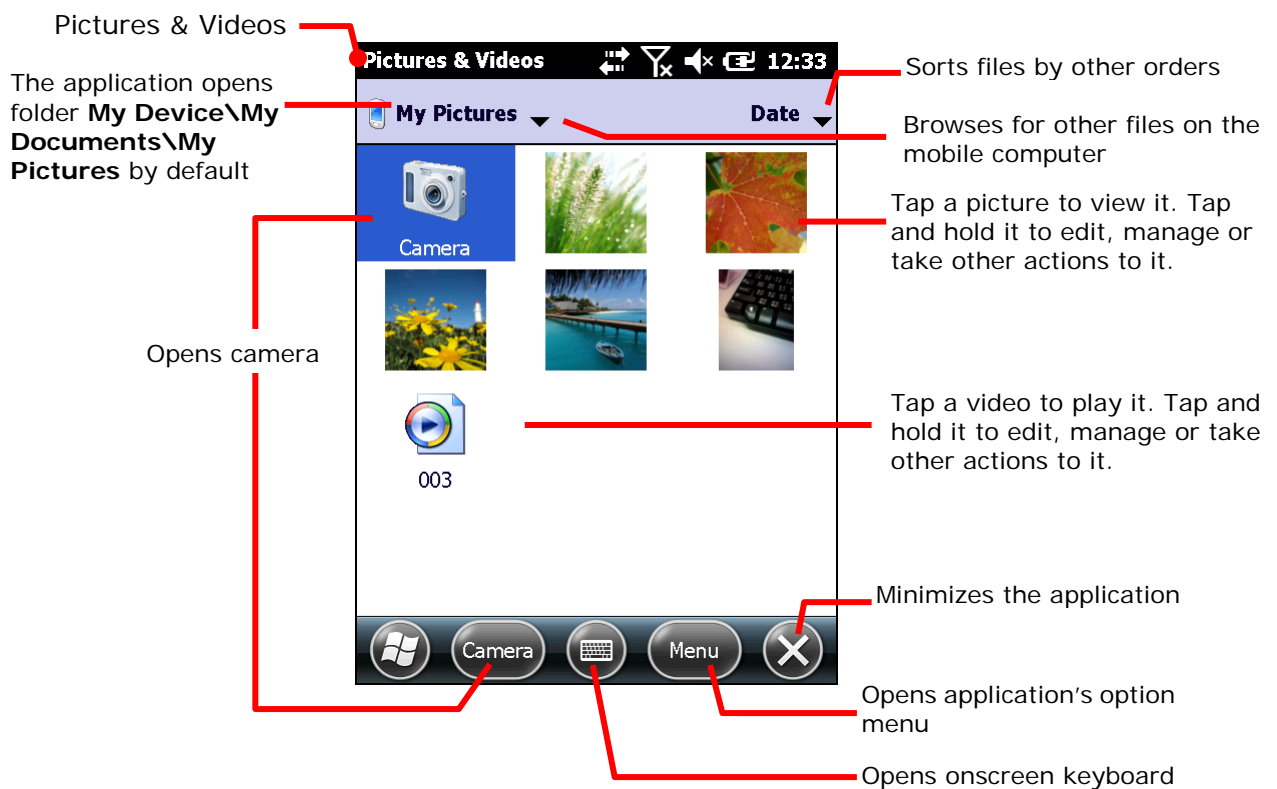

VIEW A PICTURE OR VIDEO

To view a picture or video:

- 2) Open Pictures & Video as described in [Launch Pictures & Videos](#).
Pictures & Videos opens.
- 3) Tap the thumbnail of the picture or video to view.
The picture displays or the video starts to play onscreen.

TAKE OTHER ACTIONS TO A VIDEO OR PICTURE

To edit, manage or take other actions to a video or picture:

- 1) Open Pictures & Video as described in [Launch Pictures & Videos](#).
Pictures & Videos opens.
- 2) Tap and hold the thumbnail of the picture or video to edit, manage or take other actions to it.
A context menu comes up.
- 3) Tap a menu item to perform the desired action.

OR

Tap the thumbnail of the prospective picture or video.

It becomes selected with highlight.

Tap the command button that comes up on the softkey bar.

OPERATING SYSTEM

The mobile computer is powered by Windows Embedded Handheld 6.5, a member of Windows Embedded family branded for full compatibility with Windows Mobile 6.5.

Windows Embedded Handheld 6.5 features a prettier UI and a series of fresh new looks unseen in the predecessor Windows CE. The most important enhancement of all is those touch-friendlier UI elements such as the inertial scrolling of lists and redesigned context menus. These elements are offered throughout the platform and are particularly helpful for mobile computing. Users rely only on a few basic gestures such as Tap or Flick to navigate within the OS.

Windows Embedded Handheld 6.5 also features a [Today Screen](#). The [Start Screen](#) on the other hand lays out application icons in a staggered manner to maximize the space available to touch each icon and increase icons allowed onscreen.

This chapter goes through the basics of the OS and guides to [Today Screen](#) and [Start Screen](#) where all features on the mobile computer are accessible from.

4. IN THIS CHAPTER

4.1 1st Startup	92
4.2 Today Screen	95
4.3 Start Screen	97
4.4 Suspend & Reset Mobile Computer	107
4.5 Set Screen Lock.....	110
4.6 Work With Menus.....	111
4.7 Manage Applications.....	113

4.1. 1ST STARTUP

Finished with the setup as described in [Main Battery Setup](#) and [Insert SD Card](#), proceed to power on the mobile computer as described in [Power on](#).

Without a SIM card installed, the mobile computer is still able to connect to an available Wi-Fi hotspot for data. To learn more, see [Use Wi-Fi](#).

When the mobile computer first powers on, the OS boots into [Today Screen](#):

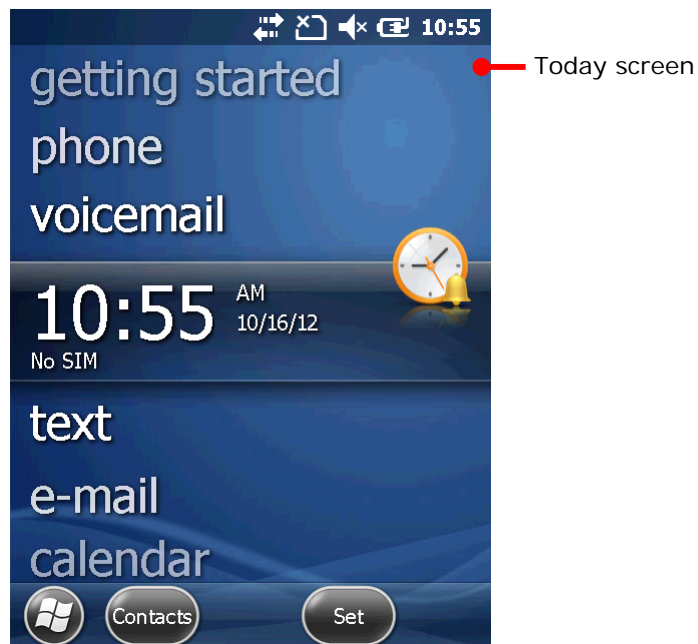

4.1.1. EXIT CIPHERLAB SMART SHELL

CipherLab Smart Shell is optional software which is integrated on the mobile computer as per shipping orders. If the mobile computer has Smart Shell software installed on it, the system will enter Smart Shell right after power on or system reset.

Within Smart Shell, users can switch between carousel view and tiles view, and easily launch programs and navigate the mobile computer in a flexible and intuitional manner. While Smart Shell provides smooth and easy operation, you can also exit the software and return to OS's original interface.

To exit Smart Shell:

- 1) Tap the "favorites" icon on the Smart Shell homepage.

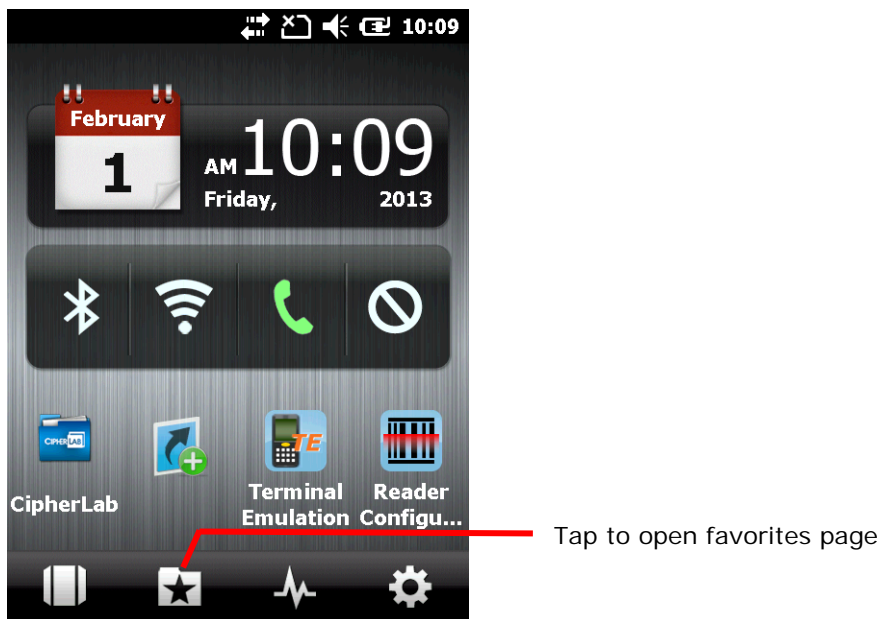

- 2) Tap the **Settings** icon to open System Settings

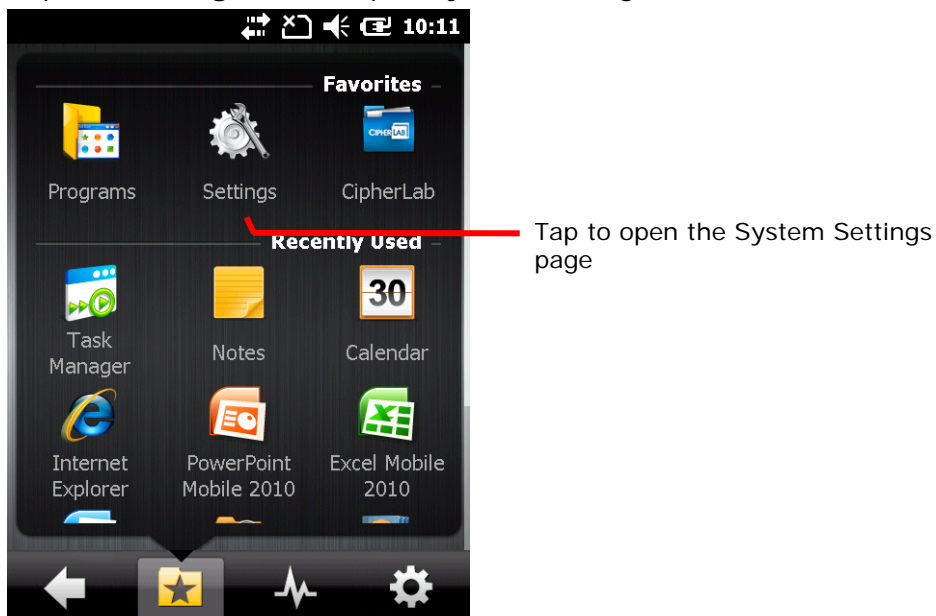

- 3) Tap **Sbp Mobile Shell** to open Smart Shell settings.



Tap to open the Smart Shell Settings

- 4) Tap the Settings icon seated on the lower right corner of the screen to open a settings menu.

Tap **Exit Shell** in the menu to exit the Smart Shell and show the OS's Today screen.



Tap to exit Smart Shell

Tap to reveal settings menu

4.2. TODAY SCREEN

It is Today screen that first shows onscreen when the mobile computer powers on or is unlocked. Today screen shows a scrollable list of applications such as pictures, music, clock & time and so on, and the application in the center is always the active one.

When an application is active, today screen displays additional information, and command buttons appear on the softkey bar to take actions to the application. Tap an active application to open it.

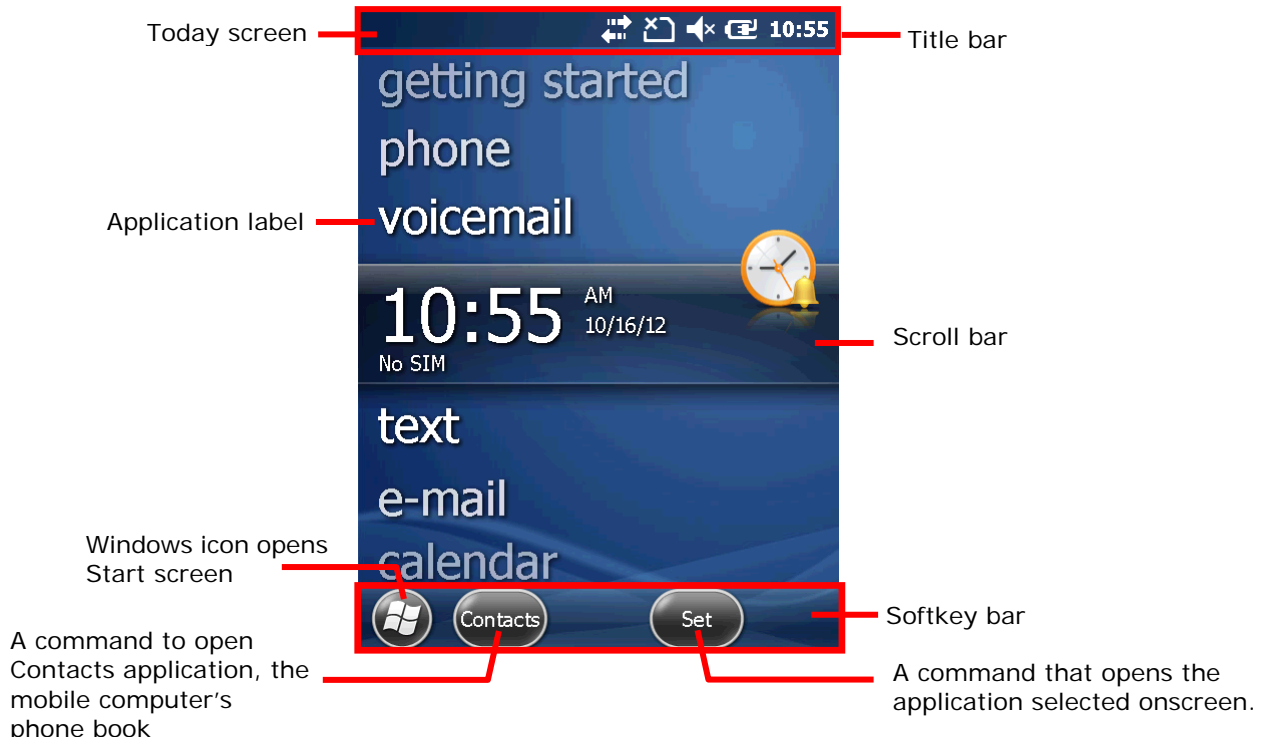

Facility	Description
Notification area	<ul style="list-style-type: none"> ▶ Shows the mobile computer's statuses such as time, radio signal strength, battery level and so on. ▶ Displays the notifications issued by OS
Scroll bar	Scrolls up and down the screen to select among the applications.
Application label	<ul style="list-style-type: none"> ▶ Delivers application name. ▶ Delivers application status when selected by scroll bar. ▶ Opens the application when selected (by scroll bar) and tapped.
Softkey bar	A horizontal rectangle bar presented at the bottom of almost every screen within the OS. It bears the commands to cause the currently active application/screen to take actions.
Command	Launch actions from the current screen or currently active application. Commands are available in context with the application selected onscreen.
Windows icon 	Opens Start screen.

4.2.1. CUSTOMIZE TODAY SCREEN

Customize Today screen to change its appearance and items presented.

To customize Today screen:

- 1) Tap Windows icon  on the softkey bar.
- 2) Tap **Settings | Home**.
Home settings open.
- 3) Select between **Appearance** and **Items** tabs.

Appearance tabbed page changes the background for Today screen while **Items** tabbed page changes the items to present.

Home Settings
- Appearance tabbed page
Changes the background for Today screen



Home Settings
- Items tabbed page
Changes the items to present on Today screen

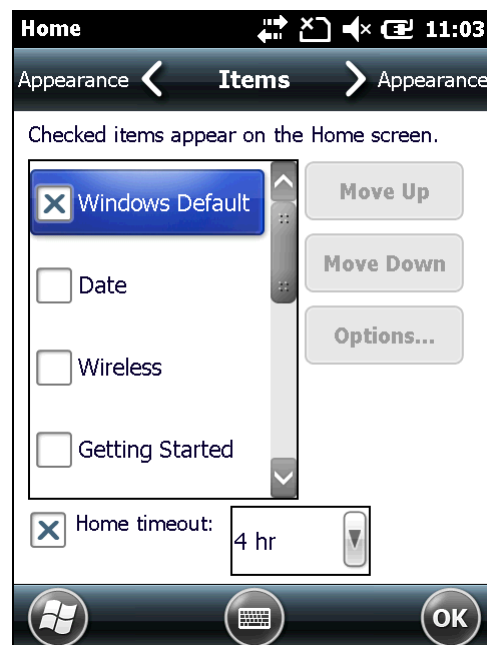

4.2.2. RETURN TO TODAY SCREEN

Tap the Home icon  on the Start screen to re-open the today screen..

4.3. START SCREEN



Start screen is where all features on the mobile computer are accessed from. This screen lays out the application icons, shortcuts and so on in a staggered manner so icons are more touchable and the number of icons allowed onscreen are increased.

Basic operations on Start screen:



- ▶ If you see the icon of the application you want to open, tap it.
- ▶ Flick the screen to scroll down and bring more application icons into view. (See also [Use Touchscreen.](#))
- ▶ Customize Start screen by changing background and the items to display. See [Customize Start Screen](#) for more details.

Take a look around Start screen:



Facility	Description
Start screen	Accesses all applications and settings.
Notification area	Shows the time, radio signal strength, battery status, and other information. It also displays notification icons and status icons.
Minimize button 	Minimizes the active application or current screen.
Windows icon 	Opens Start screen. <ul style="list-style-type: none"> ▶ If the Start screen is the active screen, tapping the Windows icon will open the Today screen.
Lock icon 	Locks screen.

4.3.1. RETURN TO START SCREEN

Tap Windows icon  on the softkey bar or press the physical Windows key  to return to Start screen.

4.3.2. TITLE BAR

At the top of almost every screen is Title bar. It shows a title on the left and a notification area on the right. The title delivers the name of the current screen or currently active application while notification area shows a sequence of graphic icons delivering system statuses or notifications issued to users.

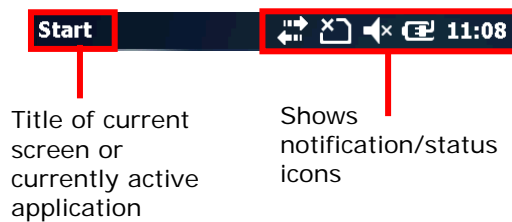





































Status icons assert mobile computer's contiguous statuses such as time, radio signal strength, battery level and so on. Notification icons report the arrival of a new message, alarm, and some ongoing events. When a notification is issued, an icon comes up in the notification area, and the mobile computer produces a sound or vibrates.

A general view of the status/notification icons on the mobile computer:

STATUS & NOTIFICATION ICONS

The OS presents the following icons for users. Note there may be application-particular icons not included here.

-  External power connected
-  Battery level (See [Monitor Battery Level](#) for details.)
-  Numeric keypad enters symbols; QWERTY keypad enters uppercase letters.
-  Numeric keypad enters alphabetic letters; QWERTY keypad enters numbers/symbols.
-  Keypad Function mode is on.
-  System sound enabled
-  System sound muted
-  Vibrator on
-  No SIM card installed
-  3G+ network available
-  3G+ network connected
-  3G network available
-  3G network connected

-  HSDPA network available
-  HSDPA connected
-  EDGE network available
-  EDGE connected
-  GPRS network available
-  GPRS connected
-  Phone off
-  SIM card locked. PIN code required to turn on phone
-  Phone on with signal strength
-  Connection is active
-  Connection is inactive
-  Wi-Fi on but not connected
-  WiFi available
-  WiFi connected
-  Bluetooth in use
-  Bluetooth headset in use
-  Alarm on
-  More notifications to be viewed. Tap Title bar or tap the “Notification” command on the softkey bar to view them all.
-  Email received
-  Text message received
-  Syncing data with a Windows-based PC
-  Roaming
-  Microsoft’s appeal for customer feedback to help improve Windows Embedded Handheld software.

To learn more status icons of mobile/wireless data connections, see [Radios](#).

4.3.3. MANAGE NOTOFICATIONS

Status/notification icons are relatively small, however by tapping the Title bar, a drop-down bar will appear to provide larger icons for managing notifications.

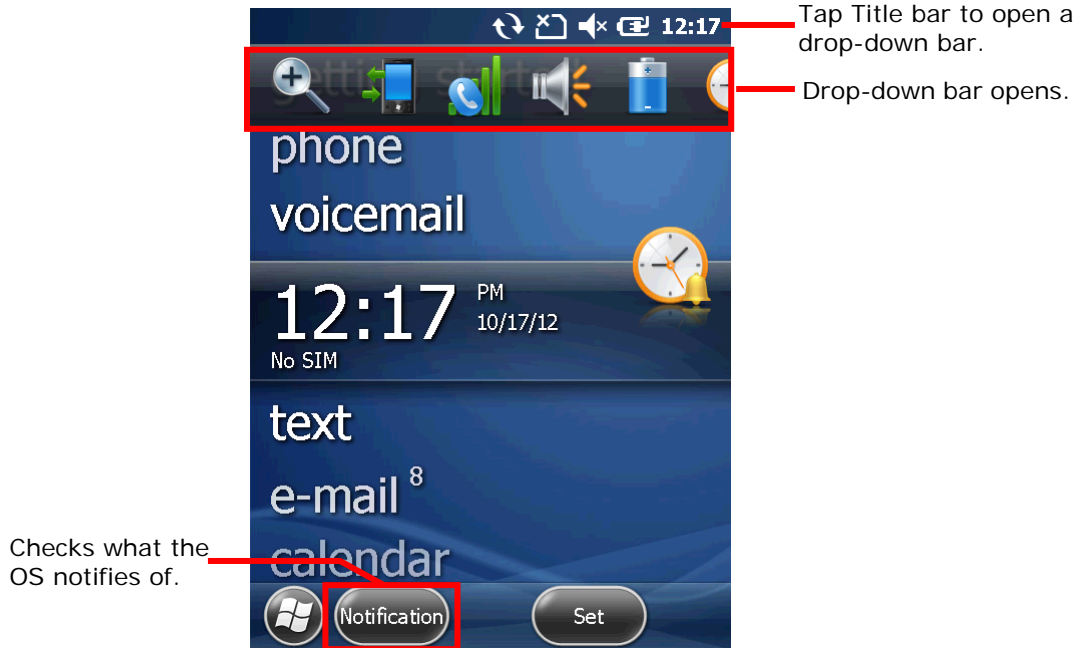

Note there are commands that come up on the softkey bar to manage a notification. A general view of bigger notification/status icons on Drop-down bar:

Icon	Description
	Zooms in/out of current screen.
	Leads to Wireless Manager and Connections (Manager) where your current mobile data can be viewed and configured.
	Leads to Wireless Manager and phone setting where phone status can be viewed and phone can be configured.
	This icon signifies Wi-Fi network(s) are available. See Use Wi-Fi for how to set up a Wi-Fi connection.
	Delivers current system volume and opens volume settings. See Onscreen Volume Gauges for more details.
	Opens power settings where battery level and charging status can be viewed. See More Charging Info .
	Opens Clock & Alarms settings.
	Reports customer feedback to Microsoft for improving Windows Embedded Handheld software.



Opens the reminder for an alarm or appointment.



Bluetooth A2DP profile in use. Tap it to access Bluetooth devices list.



Checks a new e-mail.



Opens Text application.



Roaming on

RESPOND TO NOTIFICATIONS

- 1) Tap Title bar to open Drop-down bar.
Drop-down bar opens.
- 2) Tap the status/notification icon to manage.
Drop-down bar closes and you are taken to the application in question.

CLEAR NOTIFICATIONS

A notification won't be cleared until it is managed. Upon receiving a notification, tap Title bar to open Drop-down bar to manage it, or tap the action command which appears on the softkey bar.

4.3.4. CUSTOMIZE START SCREEN

Customize Start screen by changing the background, application shortcuts, and so on. Rearrange the application shortcuts to make the applications that you use most often easiest to access.

CHANGE BACKGROUND

Craft your Start screen and Today screen with any of your own pictures or a number of designer themes bundled with the OS.

APPLY ONE OF YOUR OWN PICTURES

- 1) On Start screen, tap **Pictures & Videos** .
Pictures & Videos opens.
- 2) Tap a picture. The picture opens. Tap the "Menu" command on the softkey bar.

OR

- 1) Tap and hold a picture.
Context menu shows up directly.
- 3) Tap **Set as Home background**.
The picture is set as background

APPLY ONE OF THE DESIGNER THEMES

- 1) On Start screen, tap **Settings | Home**.
Appearance tabbed page opens.
- 2) Tap a theme from the list.
- 3) Tap the "OK" command on the softkey bar.
Change is applied to Today & Start screens.

MOVE APPLICATION SHORTCUTS ON START SCREEN

On Start screen, you can re-tile the application shortcuts (icons) as you like. For example, move your favorite applications atop others:

- 1) Tap and hold an application icon until it is hoisted by a white border.
- 2) Drag the application icon and do not release until it reaches the desired position.

ADD ITEMS TO START SCREEN

A variety of shortcuts can be added to Start screen to quick-open some files or bookmarked webpages or applications.

The mobile computer relies on File Explorer , one of the OS featured applications, to add application shortcuts to Start screen:

ADD APPLICATION SHORTCUTS

- 1) On Start menu, tap File Explorer .
File Explorer opens.
- 2) Browse to the executable file of the application to add shortcut for.

- 3) Tap and hold the executable file.
A context menu comes up.
- 4) Tap **Copy**.
- 5) Browse to **My Device\Windows\Start Menu\Programs**.
Programs folder opens.
- 6) Tap and hold any vacant spot onscreen.
Context menu comes up
- 7) Tap **Paste Shortcut**.
The application shortcut is added to Start screen.

ADD BOOKMARKED WEBPAGE SHORTCUTS

- 1) On Start screen, tap File Explorer .
File Explorer opens.
- 2) Browse to **My Device\Windows\Favorites**.
- 3) Tap and hold the bookmark to create shortcut for.
Context menu comes up.
- 4) Tap **Copy**.
- 5) Browse to **My Device\Windows\Start Menu\Programs**.
Programs folder opens.
- 6) Tap and hold any vacant spot onscreen.
Context menu comes up
- 7) Tap **Paste Shortcut**.
Shortcut to the bookmarked page is added to Start screen.

ADD FILE SHORTCUTS

- 1) On Start screen, tap File Explorer .
File Explorer opens.
- 2) Browse to the file to create shortcut for.
- 3) Tap and hold it.
Context menu comes up.
- 4) Tap **Copy**
- 5) Browse to **My Device\Windows\Start Menu\Programs**.
Programs folder opens.
- 6) Tap and hold any vacant spot onscreen.
Context menu comes up.
- 7) Tap **Paste Shortcut**.
Shortcut to the file is added to Start screen.

REMOVE ITEMS FROM START SCREEN













The mobile computer relies on File Explorer  to remove an application shortcut from Start screen:

- 1) On Start screen, tap File Explorer .
File Explorer opens.
- 2) Browse to **My Device\Windows\StartMenu\Programs**.
Programs folder opens. This is where all applications/bookmarks/file shortcuts are.
- 3) Tap and hold the shortcut to remove.
Context menu comes up.
- 4) Tap **Delete**.
The shortcut is removed from Start screen.

4.3.5. START SCREEN ICONS

Start screen presents a number of icons in a staggered pattern that makes them easily touchable. Each icon opens an application, folder or a group of settings when it is tapped. This section will give an overview of these icons.

Icon	Name	Description
	Home (Today)	Opens Today screen. See Today Screen .
	E-mail	Pens and sends emails.
	Phone	Launches the mobile computer's phone. (Data transmission only)
	Internet Explorer	Browses world wide web.
	Calendar	Creates and manages events, meetings, and appointments.
	Settings	Accesses system settings. See System Settings for details.
	Getting Started	Opens Getting Started application to set up some OS basic features.
	Alarms	Opens Clock & Alarms application to: <ul style="list-style-type: none"> ▶ Set date, time, time zone for your locale. ▶ Set and manage alarms.
	Pictures & Videos	Views pictures and plays videos downloaded, copied or taken/shot with the built-in camera. See Pictures & Videos .
	Windows Media	Plays audio/video files.
	MSN Weather	Checks the weather of your locale and other parts of the world.
	Windows Live	Accesses Windows Live services (such as Hotmail) or searches world wide web.
	MSN Money	Checks stocks.

	Calculator	Performs mathematical calculations.
	Internet Sharing	Shares the mobile computer's mobile data connection with another computer through a USB or serial cable. See USB Internet Sharing & Bluetooth Internet Sharing for details.
	Search Phone	Searches contacts, files and other data on the mobile computer.
	Office Mobile 2000	Opens Microsoft Office suite applications including Excel Mobile, SharePoint WorkSpace Mobile, OneNote Mobile, Word Mobile, and PowerPoint Mobile.
	Notes	Creates notes by typing on the physical keypad or text entering on the onscreen keypad.
	Tasks	Creates, tracks, and manages tasks.
	File Explorer	Browses and manages the files on local storage.
	ActiveSync	Synchronizes Microsoft Office Outlook data between the mobile computer and another Windows-based computer such as your PC. See Syncing Tools and subsequent sections for more details.
	Task Manager	Monitors the active applications and CPU/memory usage on the mobile computer. See Task Manager .
	Help	Accesses OS online help.
	Remote Desktop Mobile	Connects to a remote computer.
	SimTKUI	Accesses the WAP/XML services provided by your mobile carrier.

4.4. SUSPEND & RESET MOBILE COMPUTER

To save from repeatedly charging and replacing batteries, suspend the mobile computer when you are not actively using it. "Suspension" is a state to hold the device from running without turning off power. It is a "soft-off" state which enables less power consumption, and also a state from which a device can quickly awake since there is no need to restart the software (applications).

4.4.1. SUSPEND MOBILE COMPUTER

The mobile computer is suspendible both manually and automatically. See also [Wake Up Mobile Computer](#).

MANUAL SUSPENSION

- 1) Press the power button without holding it.
Power menu opens.
- 2) Tap **Suspend** in the power menu.
The mobile computer enters suspension.

OR

After pressing the power button, take no actions and let the mobile computer enter suspension automatically after the five-second countdown.

AUTO-SUSPENSION

Set up a power plan to suspend the mobile computer in an apt timing.

To set up a power plan:

- 1) On Start screen, tap **Settings | System | Power Information**  .
Power setting opens showing Battery tabbed page.
- 2) Tap **Advanced** tab.

Advanced tabbed page opens.

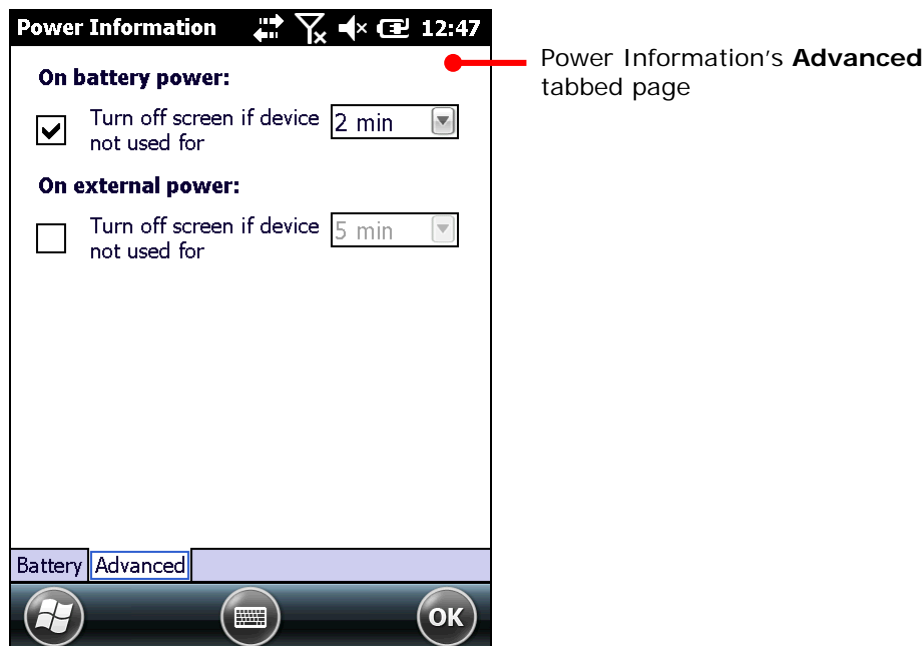

3) Set a time to turn off LCD and suspend the mobile computer.

Note the following cases also suspend the mobile computer:

- ▶ Battery door isn't in place.
- ▶ Battery fails.
- ▶ When the touchscreen of the mobile computer is facing down

To get the most from the battery power, see [Optimize Battery Life](#).

4.4.2. WAKE UP MOBILE COMPUTER

“Waking up” refers to restoring the suspended device to its previous working state. The mobile computer can be awoken both manually and automatically.

MANUAL AWAKENING

Press (without holding) the power button or central scan key to wake up the mobile computer.

AUTO-AWAKENING

The mobile computer wakes up by itself when either of the following happens:

- ▶ USB or serial cable is plugged in
- ▶ AC power cord is plugged in
- ▶ WWAN ringing signal occurs
- ▶ RTC alarm occurs

Note: There are certain cases when the mobile computer cannot be awoken:

- (1) When battery door isn't installed in place.
- (2) Imperfect contact exists between main battery and battery chamber contact pins.

4.4.3. RESET MOBILE COMPTUER

The mobile computer features two reset mechanisms, warm boot and cold boot. Performing these two resetting acts helps resolve certain problems within the OS and applications. These two actions can be performed by combined use of the power button and the reset toggle located on the mobile computer's keypad.

[1] Power button

[2] Reset toggle



Figure 16: Reset

WARM BOOT (SOFT RESET)

“Warm boot” is also known as “soft reset”. When the mobile computer runs slower than normal or when one or more active applications crash, perform warm boot to close all active applications and restart the mobile computer without turning off power supply to hardware.

After warm boot, all flash memory, system settings and clock/calendar time are kept, and all saved data are preserved. However unsaved data is gone after warm boot if the warm boot is performed when the application in question is still running.

To perform “warm boot”:

- ▶ Poke the reset toggle using the stylus.

COLD BOOT (HARD RESET)

“Cold boot” is also known as “hard reset”. In case one or more applications are misbehaving and the mobile computer doesn't cooperate, perform cold boot as the final act.

“Cold boot” restarts the mobile computer by turning power off and then powering on again. As “Cold boot” initializes DRAM, all data cached in DRAM is gone after cold boot. However all flash memory, system settings and clock/calendar time are preserved.

To perform “cold boot”:

- ▶ Press and hold the physical Power button and poke the reset toggle.

Note Power button should be held down and not released until the mobile computer powers on again.

4.5. SET SCREEN LOCK

For the sake of security, you may want to restrict the access to the mobile computer by a self-set password. The OS supports setting up a password to recover the access to the mobile computer.

To set up an unlock password:

- 1) On Start screen, tap **Settings | Lock**.
Password setting opens.
- 2) Configure how much time the mobile computer should be left unused before locking out the screen. Set up a unique password to unlock the screen.
- 3) Tap the "OK" command on the softkey bar to apply the change and quit setting.

4.5.1. UNLOCK SCREEN

Once a screen lock is set, the screen locks out all access after the mobile computer is left idled for the defined time. To recover access to the mobile computer:

- 1) On the locked screen, tap and drag the lock icon  to the right or left.
An onscreen keypad appears resembling an average phone keypad.
- 2) Enter either the password that unlocks the screen or an emergency call number.

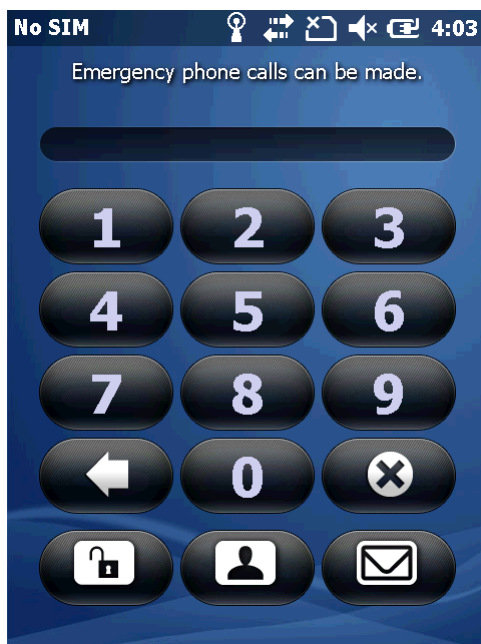

Enter the password to unlock screen.

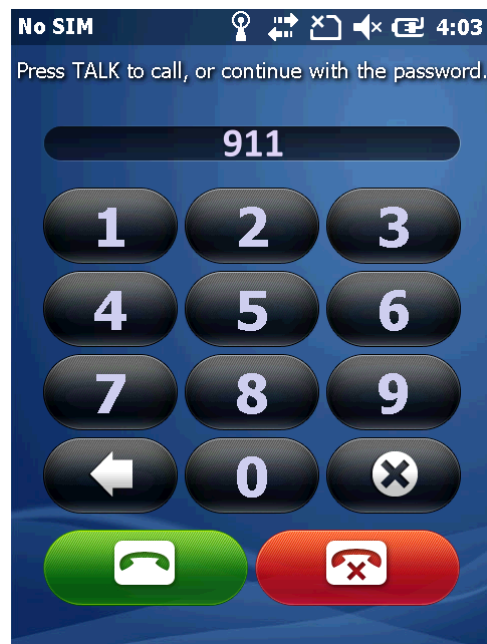

If an emergency call number is entered, the buttons to place and end calls display.

- 3) Follow onscreen instructions to proceed.

4.6. WORK WITH MENUS

The OS presents two kinds of menus: option menus and context menus. By these menus, users are able to operate onscreen and use applications.

4.6.1. OPTION MENU

Normally a screen or an active application features a “Menu” command  on the softkey bar to launch an “option menu”, which causes actions to be taken by the screen or the active application. Examples are:



Internet Explorer features a menu bar along the bottom that includes a “Menu” command to open a option menu.

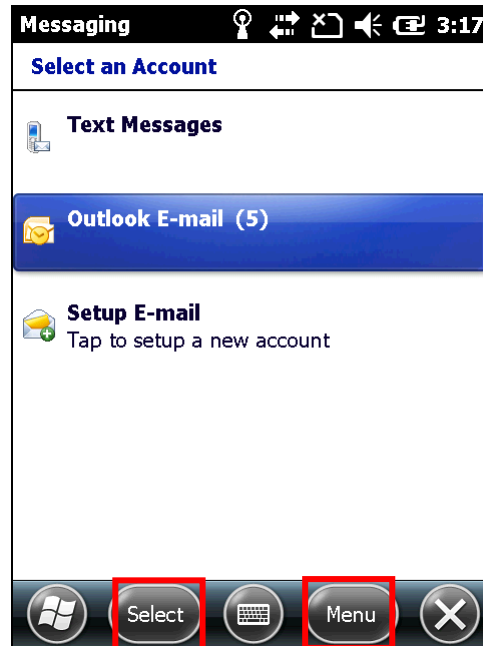

E-mail application features two commands on the softkey bar. Tap a command to produce actions taken by the application.

Note some screens/applications may not have an option menu.

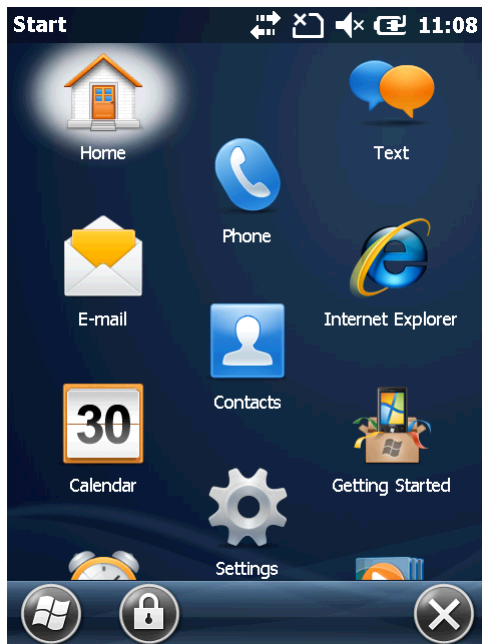

A screen that doesn't feature a "Menu" command on the softkey bar.

An example of Start screen.

4.6.2. CONTEXT MENUS

The context menu on the other hand contains the actions to be performed on a specific item selected onscreen. Tap and hold an onscreen item to open the context menu.

Not all items have context menus. Nothing happens if you tap and hold such an item.

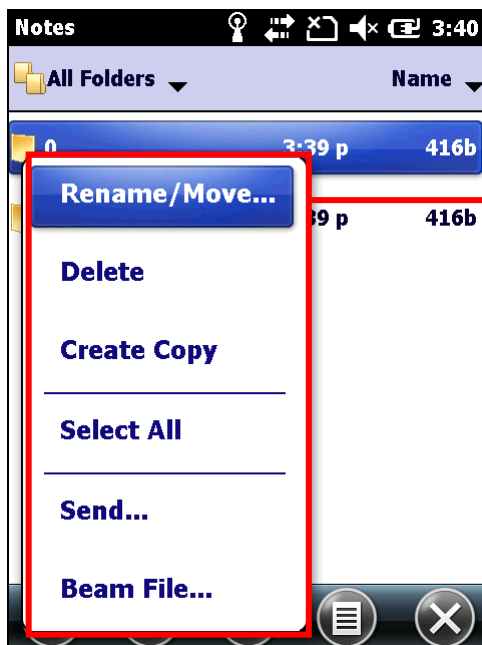

A context menu launches for a selected item.

An example of Notes application.

4.7. MANAGE APPLICATIONS

On Windows Embedded Handheld 6.5, Start screen is where all inherent applications of the OS are accessed from.

In the OS, when you run an application, the other applications that have been running don't shut down but keep on running whether it is music that is being played or a webpage that is being browsed.

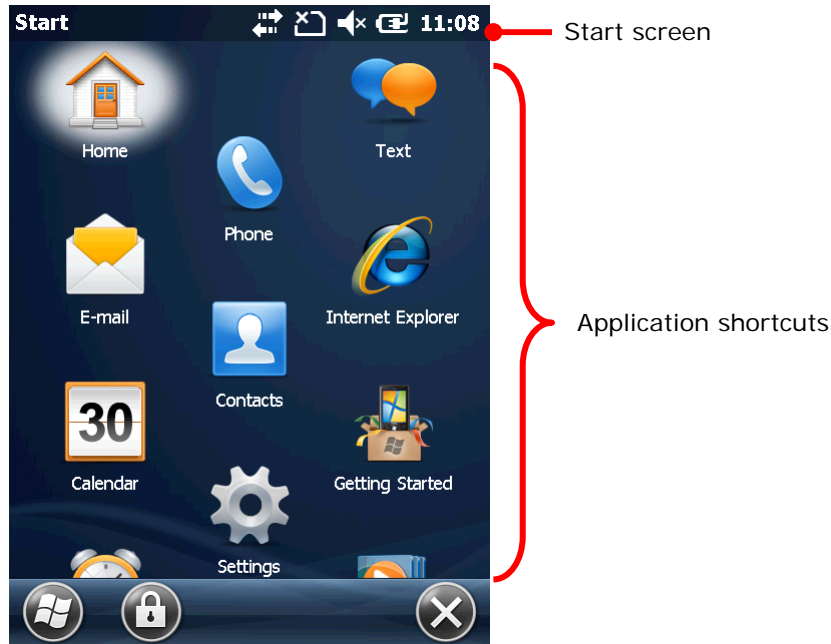

4.7.1. TASK MANAGER

The OS featured Task Manager  is a tool to monitor the memory and CPU resources consumed by each running application and cached process. Task Manager also provides an interface for users to close applications and switch between the opened applications.

LAUNCH TASK MANAGER

To launch Task Manager:

- 1) On Start screen, tap Task Manager icon .
Task Manager opens showing monitored applications.

MONITOR OPENED APPLICATIONS

Upon launch, Task Manager shows a list of all opened applications which are under monitor:

Task Manager screen

"Application" shows a list of opened applications which are being monitored

Closes the application selected onscreen

Delivers the application's memory usage. Tap to ascend/descend the entries

Deliver the application's CPU usage. Tap to ascend/descend the entries

Opens Task Manager's option menu

Application	Mem	CPU
ActiveSync	1.02M	0 %
IE Mobile Home	744K	0 %
Notes	196K	0 %
File Explorer	108K	0 %
Task Manager	100K	0 %

To monitor cached processes, see [Monitor Cached Processes](#).

CLOSE APPLICATIONS

Close an application when it isn't used, or when it is misbehaving. Check for any misbehaving applications by looking up its usage of memory and CPU.

In the OS, how to close an application varies. Some applications have inherent facilities to close themselves such as a GUI button or a menu command while others don't. When it is the latter case, Task Manager closes them for you.

To close an application by Task Manager:

- 1) Launch Task Manager as described in [Launch Task Manager](#).
Task Manager opens monitoring opened applications.
- 2) Tap and hold the application to close. From the context menu that comes up, tap **End Task**.

OR

Tap the application to close. The application is then highlighted onscreen. Tap the "End Task" command on the softkey bar.

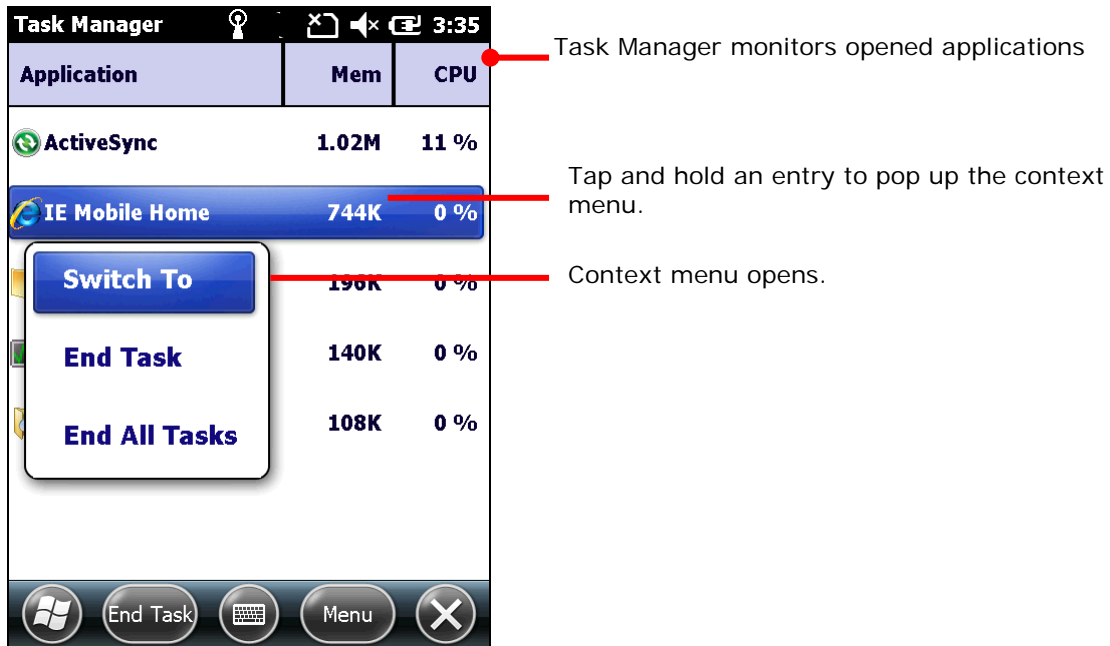

SWITCH TO ANOTHER OPENED APPLICATION

To switch to another opened application:

- 1) Launch Task Manager as described in [Launch Task Manager](#).
Task Manager opens monitoring opened applications.
- 2) Tap and hold the application to switch to.
Context menu shows up.
- 3) Tap **Switch to**.
The desired application opens onscreen.

MONITOR CACHED PROCESSES

Task Manager  also monitors how much RAM and CPU is being consumed by a cached processes.

To monitor cached processes:

- 1) Launch Task Manager as described in [Launch Task Manager](#).
Task Manager opens monitoring opened applications.
- 2) Tap the "Menu" command on the softkey bar.
Option menu opens.
- 3) Tap **View | Processes**.

Task Manager shifts to monitor processes.

Task Manager monitors cached processes.

Process	Mem	CPU
connmgr.exe	324K	0 %
cprog.exe	1.53M	0 %
device.exe	10.7M	1 %
fexplore.exe	108K	0 %
filesys.exe	14.0M	0 %
gwes.exe	5.59M	0 %
iexplore.exe	744K	0 %

Note: Stopping an application or process or service may interrupt one or more dependant functions on the mobile computer. You may need to restart the mobile computer to recover full functionality.

DOWNLOAD & INSTALL APPLICATIONS

A rich resource of applications is downloadable from the Internet to run on the OS. The executable files for installing on Windows Embedded Handheld 6.5 devices are named with the suffix ".cab", short for "cabinet". Download a ".cab" file that supports Windows Embedded Handheld 6.5.

Warning: To protect your mobile computer and personal data, always download applications from trusted sources.

As mentioned in [Add/Remove Programs](#), you can download and install an application on your PC first and offload it to the mobile computer later using Microsoft's ActiveSync.

Alternatively, the OS allows you to download and install an application right from the mobile computer.

To download an application, the mobile computer needs to connect to Internet first. See [Radios](#) or [USB Pass-through Networking](#) or [Bluetooth Pass-through Networking](#) to get data connections for the mobile computer.

After download finishes, use File Explorer  to browse to the application program in the local storage. Tap the program file to run the installation.

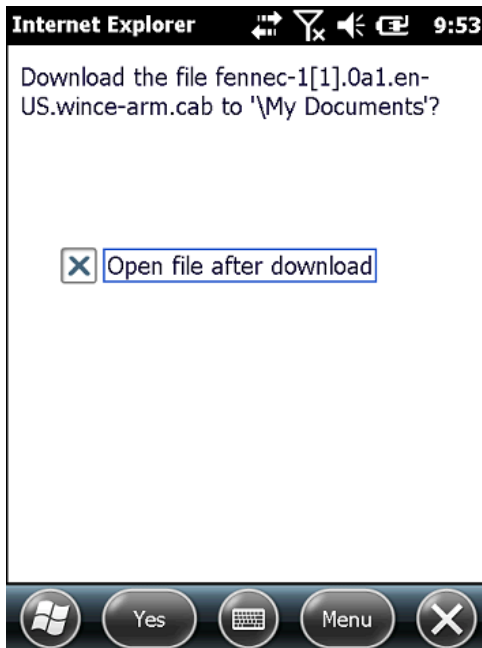

This screenshot shows downloading an application program to the mobile computer. When asked to confirm the download, tap the “Yes” command on the softkey bar.

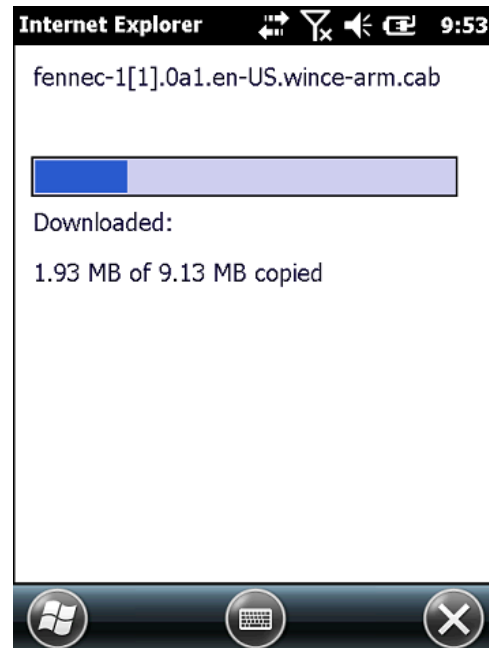

Download starts and proceeds.

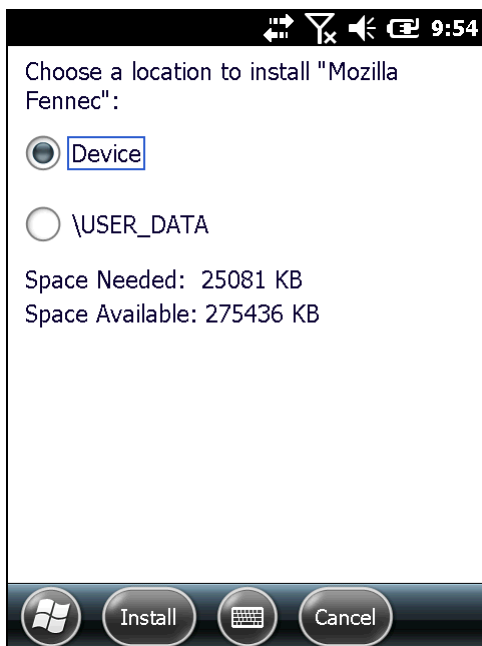

If the mobile computer is equipped with an SD card, you will be provided the option to install the application either on external or internal storage. If an SD card is not present on the mobile computer, only internal storage directories will show.

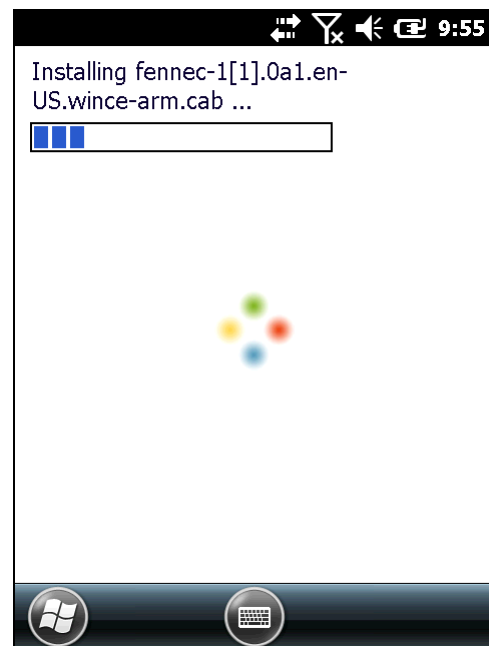

Installation begins.

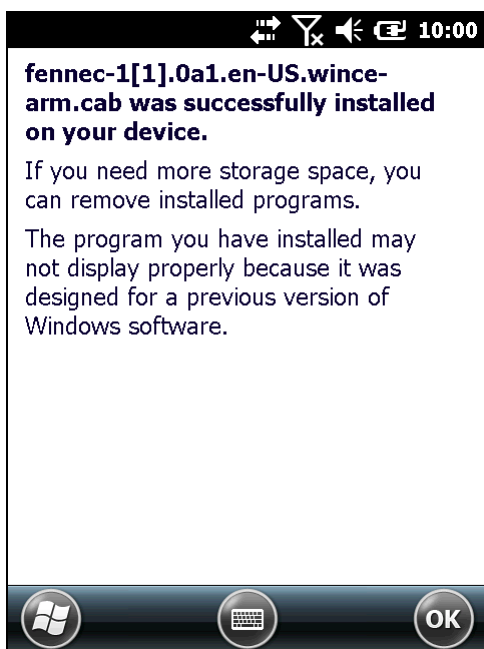

Installation is complete. Tap "OK" command to finish and quit installation.

UNINSTALL APPLICATIONS

On the mobile computer, the acquired (non-inherent) applications are subject to your manual uninstallation. To uninstall an application:

- 1) On Start screen, tap **Settings** | **System** | **Remove Programs** .

Remove Programs opens showing the applications downloaded and installed from external sources.
- 2) Tap the application to remove.

The lower-right "Remove" button becomes available.
- 3) Tap the "Remove" button to uninstall the application.
- 4) Follow onscreen instruction to complete through the uninstallation.

Currently available internal storage  Total storage memory available: 222488K

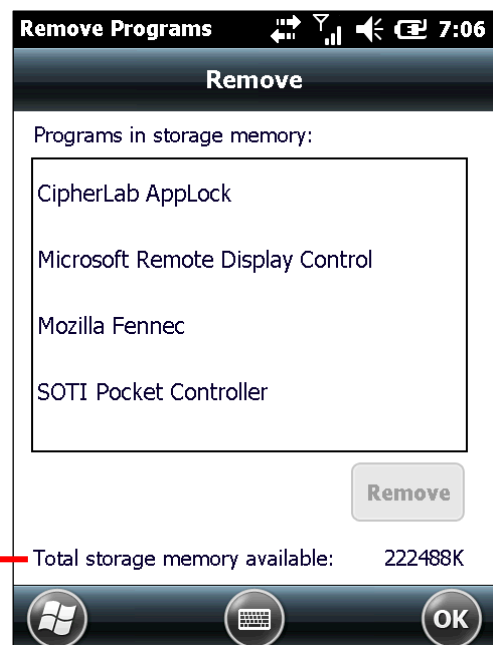

RADIOS

The mobile computer is a versatile networker. It integrates Wi-Fi and Bluetooth for wireless data, and optionally a HSPA+ (3.8G) module for mobile data. It also includes a GPS receiver which can detect your locations on earth with street-level accuracy. With the help of these radios, the mobile computer keeps users online all the time.

In this chapter, you will learn how these radios can work for you.

5. IN THIS CHAPTER

5.1 Access Cellular WAN.....	120
5.2 Use Wi-Fi.....	126
5.3 Use Bluetooth.....	150
5.4 Connect to Virtual Private Network	163
5.5 Install Secure Certificates	167
5.6 Location Discovery	169

5.1. ACCESS CELLULAR WAN













When you insert a SIM card in the mobile computer and power on the phone module, the mobile computer will connect to your mobile carrier's cellular wide area networks for data.

Different locations may have different mobile networks available. The mobile computer auto-connects to the fastest mobile network available for data.

To access the Internet, set the mobile computer to use either Wi-Fi or SIM-enabled cellular data. See also [Use Wi-Fi](#).

5.1.1. STATUS ICONS

The title bar features the following icons to deliver the mobile (WWAN) network connected to, with signal strength.

Icon	Description
	3G+ network available
	3G+ network connected
	3G network available
	3G network connected
	HSDPA network available
	HSDPA connected
	EDGE network available
	EDGE connected
	GPRS network available
	GPRS connected
	HSDPA/EDGE/GPRS in use
	Data limited to 2G only

5.1.2. CHECK NETWORK IN USE

To check what network you're using now:

- 1) On Start screen, tap **Settings** | **Connections** | **Wireless Manager** .
Wireless Manager opens.
- 2) Tap the "Menu" command on the softkey bar.
Option menu shows.
- 3) Tap **Phone Settings**.
Phone settings open showing **Sound** tabbed page.
- 4) Tap continuously on the tabs to bring **Network** tab into view.
- 5) Tap **Network** tab.

Network tabbed page opens showing the network currently connected to at the top.

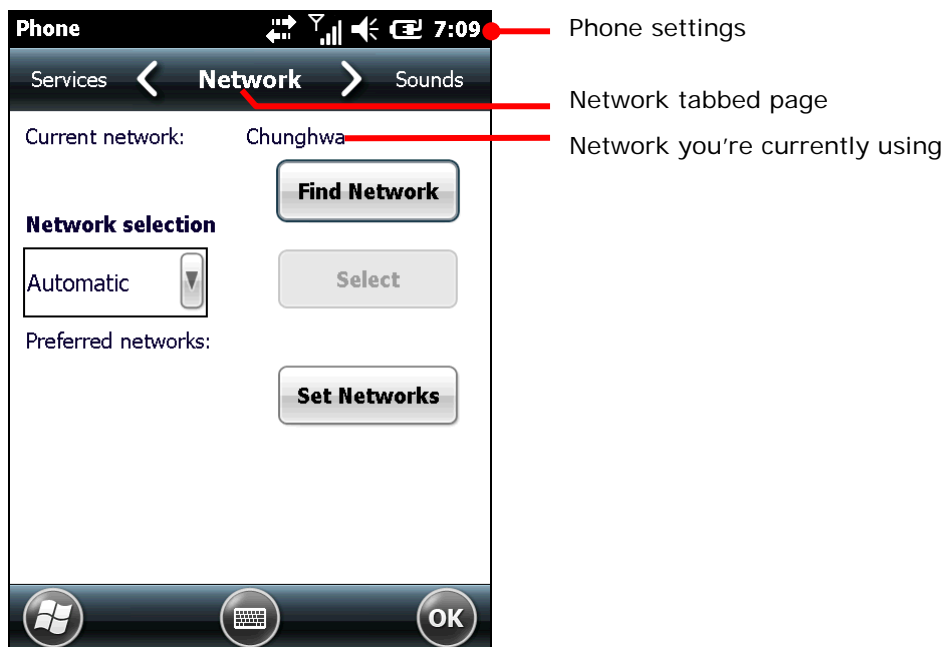

5.1.3. ENABLE/DISABLE MOBILE DATA

To turn on/off the mobile computer's mobile data (HSPA+):

- 1) On Start screen, tap **Settings** | **Connections** | **Wireless Manager** .
Wireless Manager opens.
- 2) Tap the "Menu" command on the softkey bar.
Option menu opens.
- 3) Tap **Disconnect Cellular Data**.
Mobile data is disabled.

5.1.4. USE ONLY 2G NETWORKS

Limit mobile data to 2G networks (GPRS or EDGE) to extend battery life or when you are not intensively transmitting data.

To limit mobile data to only 2G:

- 1) On Start screen, tap **Settings** | **Connections** | **Wireless Manager** .
Wireless Manager opens.
- 2) Tap the "Menu" command on the softkey bar.
Option menu opens.
- 3) Tap **Phone Settings**.
Phone settings open.
- 4) Tap continuously on the tabs to bring **GSM/UMTS** tab into view.
- 5) Tap **GSM/UMTS** tab.
GSM/UMTS tabbed page opens.
- 6) Tap **GSM (2G Only)** from the drop-down bar.
- 7) Tap **Apply** to apply the change.
- 8) Tap the "OK" command on the softkey bar to quit setting.

5.1.5. CELLULAR DATA SETUP

To set up mobile data (GPRS/EDGE/UMTS/HSPA):

- 1) On Start screen, tap **Settings** | **Connections** | **Connections** (Manager) .
Connections setting opens showing **Tasks** tabbed page.
- 2) Tap **Add a new modem connection** under **My ISP**.
Make New Connection page opens.
- 3) Name the connection.
- 4) From **Select a modem** drop-down menu, tap **Cellular Line (GPRS)**.

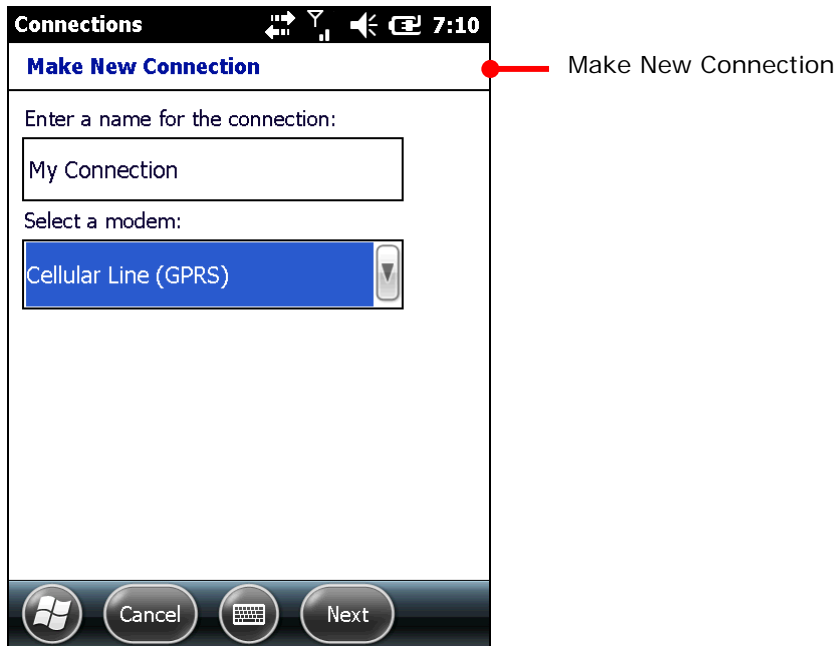

- 5) Tap **Next** to proceed.
- 6) Enter the Access Point Name (APN) of the connection. Consult your mobile carrier for such APN (for instance, "Internet").
- 7) Enter the username, password, and domain if your connection needs them. And tap the **Advanced...** button if your connection needs TCP/IP and specific server address.
- 8) Tap **Finish** on the softkey bar to apply the settings.

The mobile computer tries to connect to your mobile service. Once connected, you can check for connection as described in [Check Network in Use](#).

If you have two or more different networks set up, tapping and holding an item provides options for you to either delete or connect to the selected network.

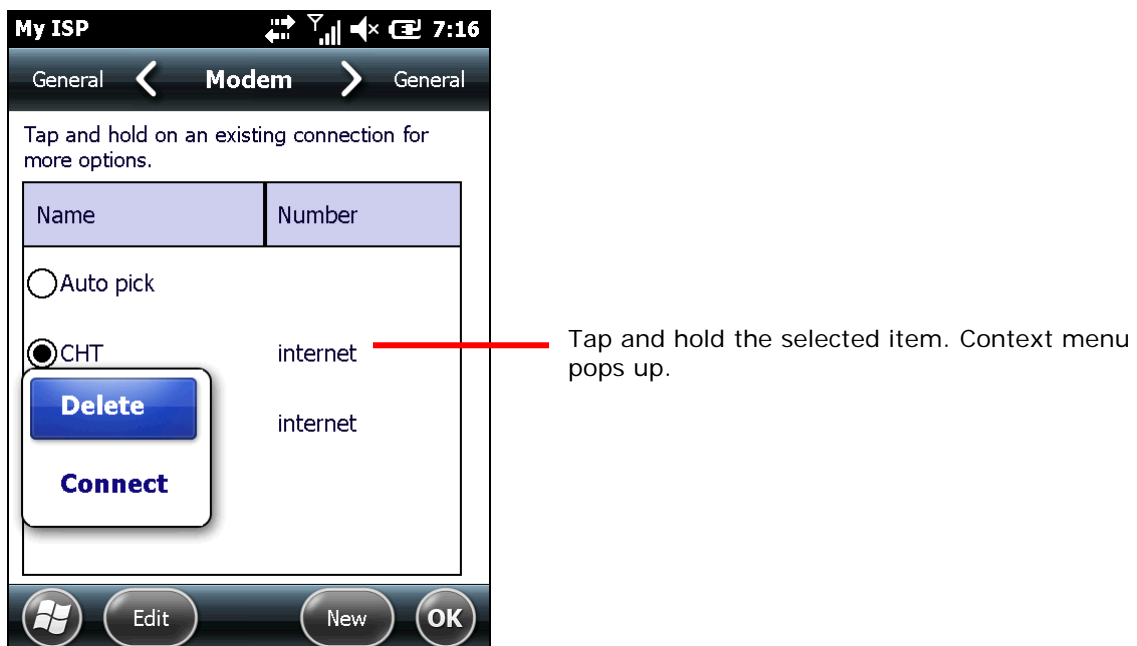

Note to turn off Wi-Fi to access mobile data because Wi-Fi supersedes mobile data.

5.1.6. EDIT & ADD ACCESS POINTS

If it is agreed between you and your mobile carrier that the current Access Point Name (APN) should be changed or a new access point needs to be created, consult your mobile carrier for the APN and detailed settings in order to have it edited.

To edit an existing APN:

- 1) On Start screen, tap **Settings | Connections | Connections** (Manager) . **Connections** setting opens showing **Task** tabbed page.
- 2) Under **My ISP** label, tap **Manage existing connections** link.

My ISP settings opens showing Modem tabbed page.

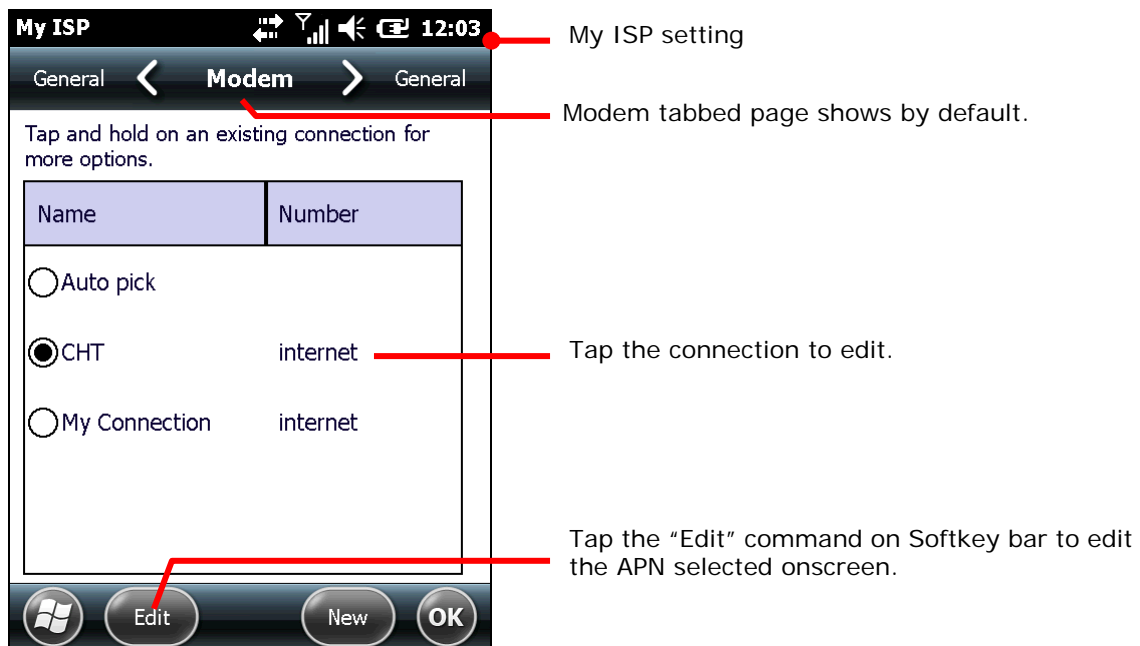

- 3) Tap the APN to edit.
The APN to edit is selected onscreen, and the "Edit" command becomes available on the softkey bar.
- 4) Tap the "Edit" command on the softkey bar.
- 5) Follow onscreen instructions to finish editing.

5.1.7. USB INTERNET SHARING

“Internet Sharing” or “Internet Tethering” enables your Windows-based PC to connect to Internet using the mobile computer’s mobile data (or dial-up data). The mobile computer functions as a Wi-Fi “hotspot” (a.k.a “access point”) that your PC connects to.

By “Internet Sharing” , the mobile computer uses USB or Bluetooth to tether your PC to Internet. For Bluetooth-based internet tethering, see [Bluetooth Internet Sharing](#).

To USB-tether your PC to Internet:

- 1) Connect the mobile computer and your PC with a USB cable that came with your purchase as described in [Direct Data Communication](#).
- 2) On the mobile computer, tap **Internet Sharing**  from Start screen.

Internet Sharing opens.

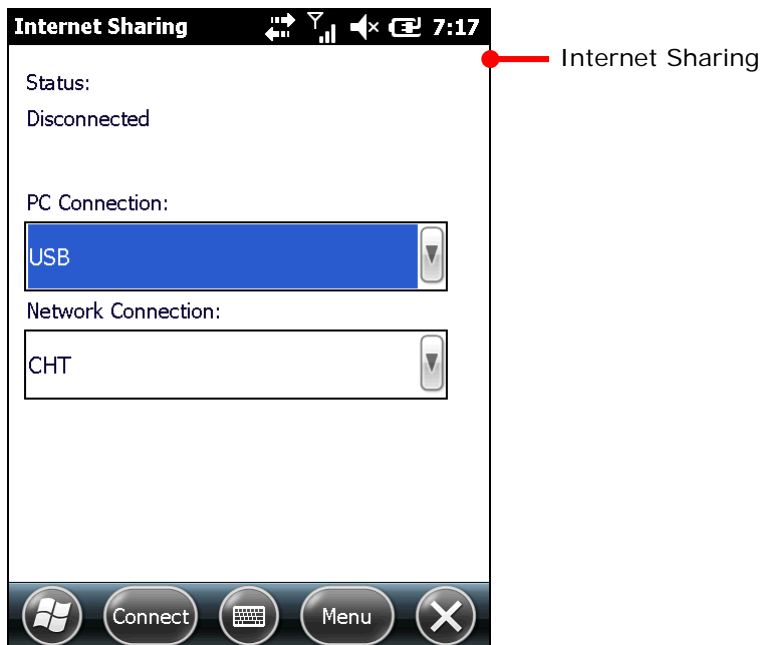

- 3) Select **USB** for **PC Connection**, and select your mobile service for **Network Connection**.
- 4) Tap the “Connect” command on the softkey bar to start Internet tethering.

The mobile computer prompts “Connected” in a few seconds when the PC connects to Internet.

Tap the “Discon...” command on the mobile computer to disconnect.

In case of problems, open Start screen | **Settings** | **System** | **USB to PC**, and make sure **Enable advanced network functionality** is selected.

5.2. USE WI-FI

The mobile computer is capable of Wi-Fi, a wireless networking technology making use of an access point, also known as “hotspot”, to connect to a wireless local area network.

To use Wi-Fi, the mobile computer has to connect to a hotspot. Some hotspots are open for connection while others request a key to authenticate access. If this is the case, the authentication key must be included in the mobile computer’s Wi-Fi settings.

For authentications based on secure certificates, see [Install Secure Certificates](#).

Wi-Fi settings and power are controlled via Summit Client Utility (SCU). Windows Zero Configuration (Wireless Manager) can only be used to view Wi-Fi power and connection status.

Turn off Wi-Fi when it isn’t used to extend battery life. See [Turn On/Off Wi-Fi Power](#).

Summit Client Utility functions by the use of Wi-Fi profiles. Profiles are a set of radio and security settings that are stored in the registry. You may create, rename, edit and delete profiles, as well as alter global settings that apply to every profile or to Summit Client Utility (SCU) itself. For more details on profile settings, please visit the following websites:

<http://www.summitdata.com/documentation.html>

http://www.summitdata.com/Documents/summit_users_guide_3_03.html

http://www.summitdata.com/Documents/summit_quick_start_v3_03.html

5.2.1. LAUNCH SCU

Wi-Fi settings can be adjusted with Summit Client Utility. Within this application are three tabbed pages which allow users to select the access point for connection, create profiles for better management, perform diagnostics on connectivity, and fine-tune property settings to meet their individual requirements.

To launch SCU:

- 1) On Start screen, tap **Settings | System | SCU** .

SCU opens showing three tabbed pages: **Status**, **Configuration**, and **Diagnostics**.

The following sections explicate in detail the settings on each of these pages.

5.2.2. STATUS TABBED PAGE

The Status tabbed page provides basic information on WLAN connection and Bluetooth status. Wi-Fi settings can be configured in [Configuration Tabbed Page](#).

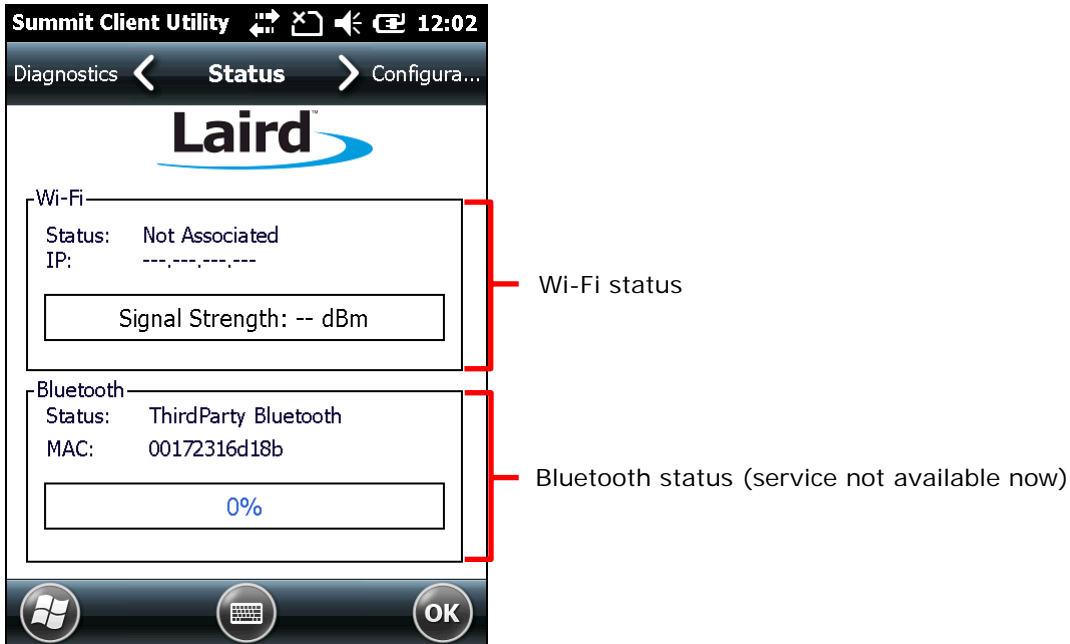

Note: SCU does not currently support viewing or configuring Bluetooth settings.

5.2.3. CONFIGURATION TABBED PAGE

TURN ON/OFF WI-FI POWER

Select the Wi-Fi checkbox to turn on Wi-Fi power. Deselect it to shut down Wi-Fi.



Note:

- (1) Wi-Fi connection status will be reflected under **Wireless Manager**, which can be accessed by tapping the **Title bar | Wireless Manager** icon, or **Start Screen | Settings | Connections | Wireless Manager**. When Wi-Fi power is off, the status will display as "No signal". When Wi-Fi power is on but no active connection is established, the status will display as "Available". When a WLAN connection is established, the status will display as "Network Card". Wireless Manager cannot be used to control Wi-Fi power.
- (2) SCU does not allow configuration of Bluetooth settings. To establish and manage Bluetooth connections, tap **Start Screen | Settings | Bluetooth**.

ACTIVE PROFILE

A profile is a set of parameters that define the manner which a device associates to a wireless LAN (WLAN) infrastructure. A profile contains information including the System Set Identifier (SSID, the "name" of the WLAN infrastructure), means of data encryption, authentication type, and security credentials.

Select an active profile in the drop-down box on the **Configuration** tabbed page. To add a profile other than the "Default" profile, see [Create Wi-Fi Profile](#).

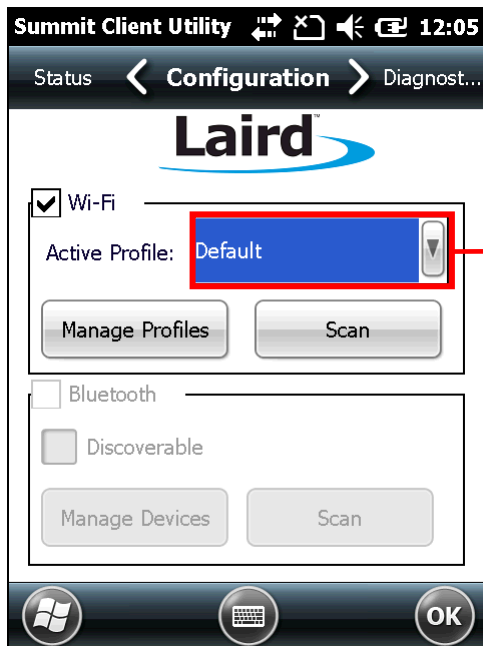

Tap to select an active profile in the drop-down bar

CREATE WI-FI PROFILE

To create a Wi-Fi Profile:

- 1) Open SCU as described in [Launch SCU](#).
- 2) Tap the **Configuration** tab to show the Configuration tabbed page.
- 3) Tap **Scan** to view a list of access points that are broadcasting their SSIDs. You may sort the list by tapping the column headers.

Tap **Refresh** to update the list of available access points.

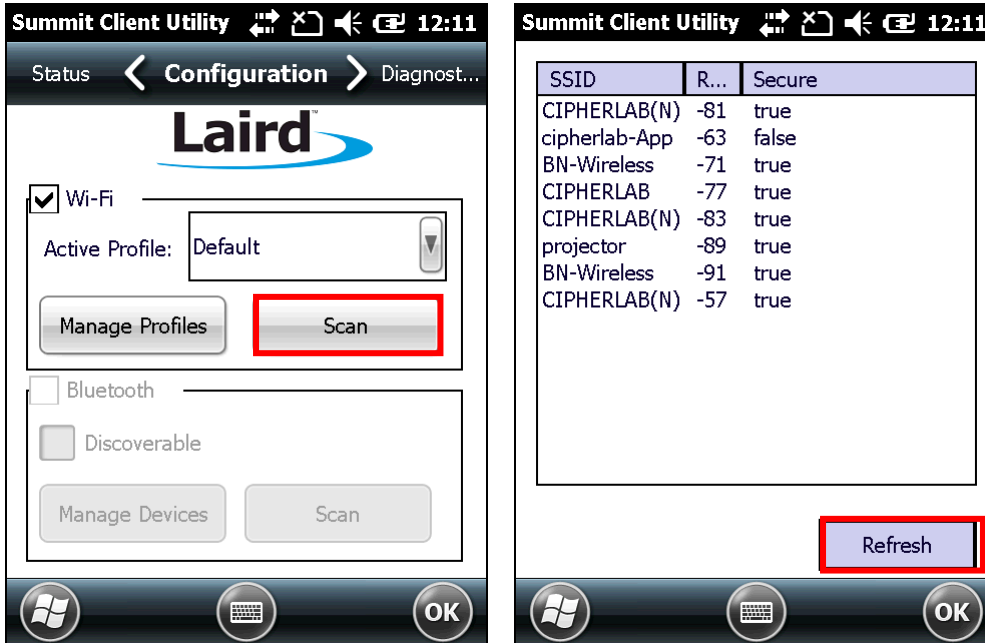

Item	Description
SSID	Service Set Identifier (SSID)
RSSI	Received Signal Strength Indication (RSSI)
Secure	Indicates whether data encryption is enabled: true or false

- 4) Tap twice on any of the access points to create a new profile for it. A prompt shows confirming whether to create a profile with the identified SSID, encryption and EAP type. Tap **Yes** to continue.

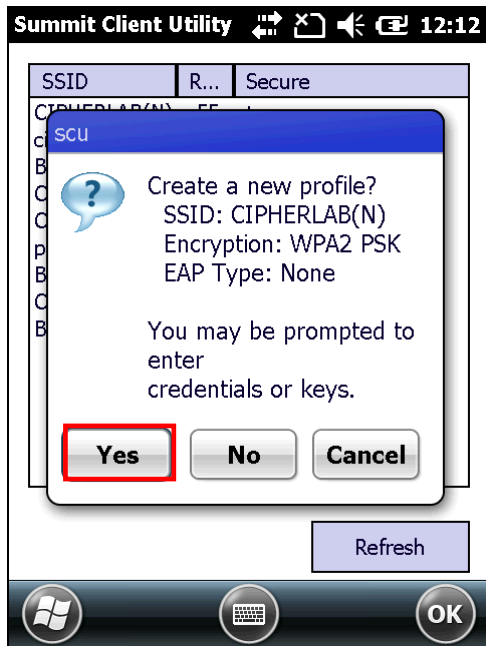

- 5) A profile settings page opens showing detailed radio settings. Tap each item and adjust its **Value** to suit your needs.

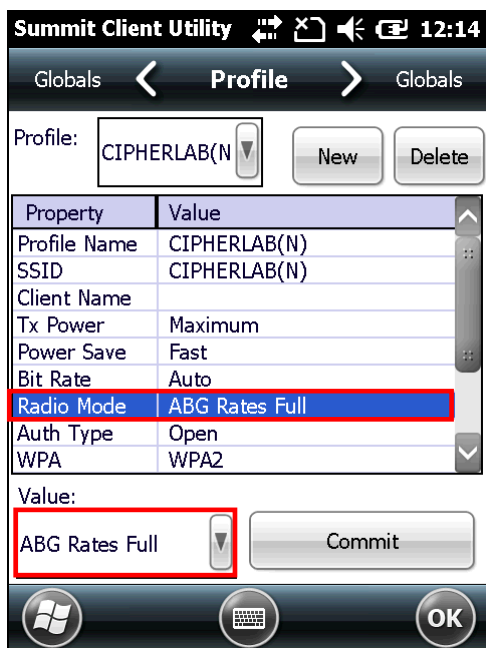

- 6) When finished fine-tuning all settings, tap **Commit** to save the profile.
- 7) Tap **OK** on the softkey bar to close Profile Settings page and return to Configuration settings.

If you would like to directly activate the newly created profile, select it as the [Active Profile](#) on the Configuration settings page.

MANAGE WI-FI PROFILE

To manage your profiles:

- 1) Open SCU's **Configuration** tabbed page as described in [Create Wi-Fi Profile](#).
- 2) Tap **Manage Profiles** to open the Profile settings page.

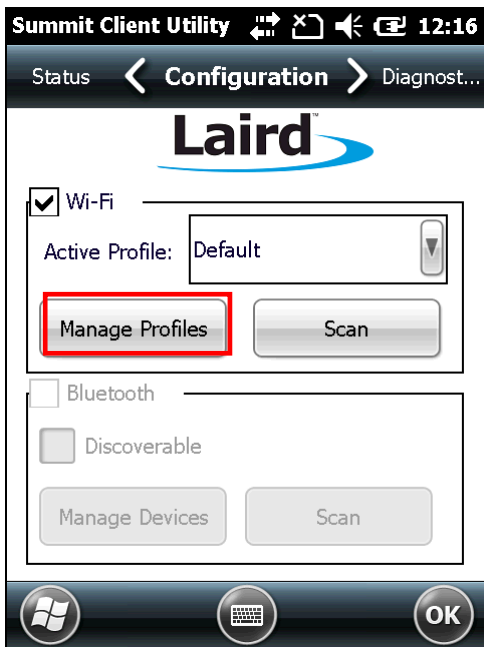

Item	Description
Profile	<p>When SCU is first launched, "Default" is the active profile. Unless it is modified, this profile does not specify an SSID, EAP type or encryption method. You can chose to do the following:</p> <ul style="list-style-type: none"> ▶ Modify the default profile ▶ Tap New to add a new profile ▶ Select an existing profile from the drop-down menu and configure

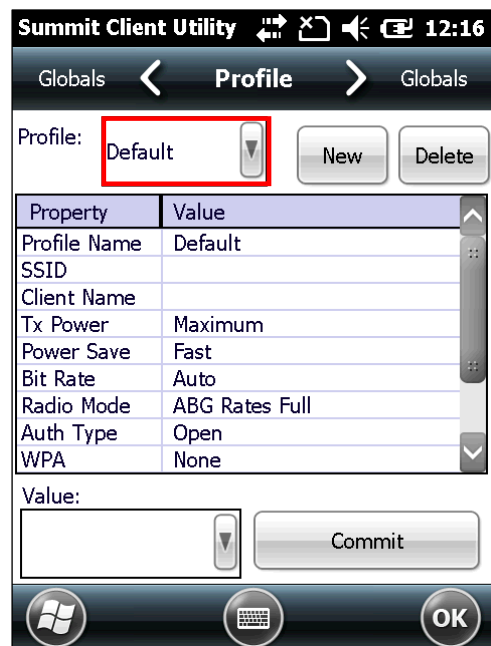

New

Tap **New** and enter a unique name for the profile. Configure the Radio settings, Encryption, EAP Type, and other settings for this new profile.

- ▶ The name for each profile must be unique
- ▶ You can define up to 20 profiles

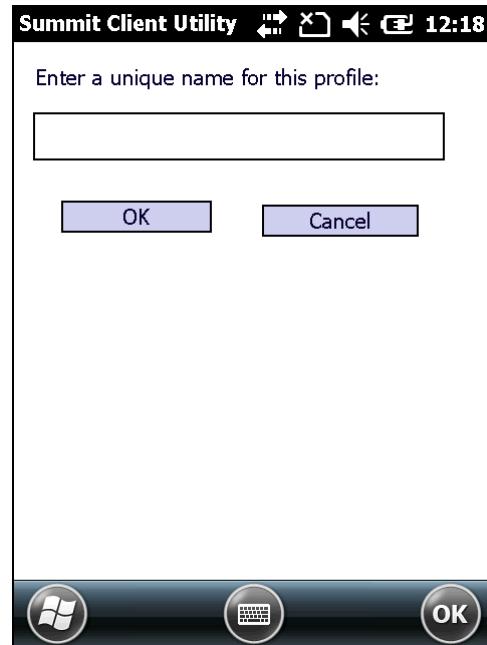
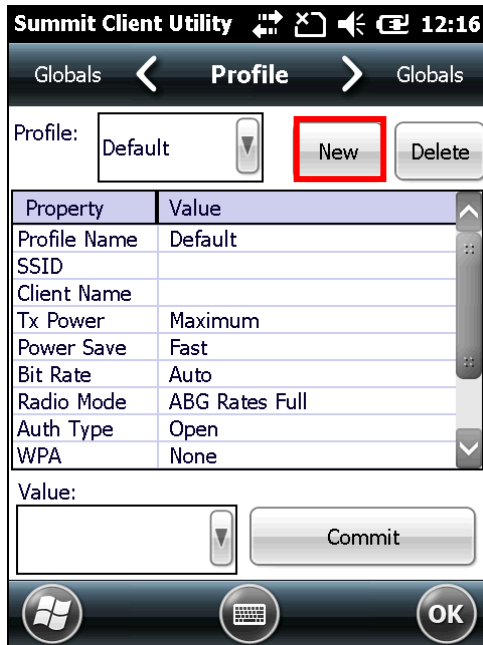

Delete

Select a profile from the drop-down menu and tap **Delete**.

- ▶ You cannot delete the [Active Profile](#). Make sure the selected profile is not the active profile under **Configuration** tabbed page.

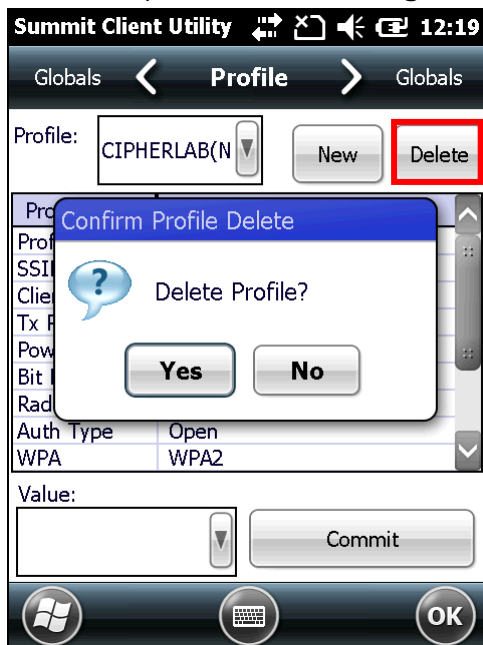

Radio Settings

After selecting a profile in the **Profile** drop-down bar, configure radio settings in the scrollable menu below.

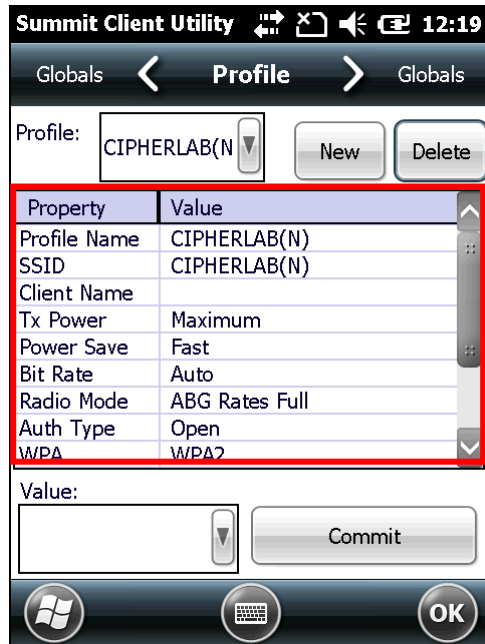

Property	Description		
Profile Name	Tap to rename the selected profile. Up to 32 characters allowed.		
SSID	Service Set Identifier (SSID) for the WLAN infrastructure to which the radio will connect. If no SSID is specified, the radio will only associate to an access point that broadcasts its SSID. <ul style="list-style-type: none"> ▶ Value: A string of up to 32 characters ▶ Default: None 		
Client Name	Name assigned to the mobile computer with Summit radio installed. <ul style="list-style-type: none"> ▶ Value: A string of up to 16 characters ▶ Default: None 		
Tx Power	The power of the radio in milliwatts (mW). In certain cases this value will be overwritten by the access point, which will dictate to the radio which power to use. <ul style="list-style-type: none"> ▶ Value: Maximum (Maximum power defined for the current regulatory domain) or a specified percentage 75%, 50%, 25%, 10% ▶ Default: Maximum 		
Power Save	Power save mode for the radio. Set the radio to its optimum power-consumption setting. <ul style="list-style-type: none"> ▶ Value: <table border="1" data-bbox="619 1861 1334 1998"> <tr> <td>CAM</td> <td>Constantly Awake Mode (CAM) keeps the radio powered up continuously so there is minimal lag in message response time. This mode consumes</td> </tr> </table> 	CAM	Constantly Awake Mode (CAM) keeps the radio powered up continuously so there is minimal lag in message response time. This mode consumes
CAM	Constantly Awake Mode (CAM) keeps the radio powered up continuously so there is minimal lag in message response time. This mode consumes		

				the most power but offers the highest throughput. It is recommended when AC power is in use.
		Maximum		In Max Power Savings (Max PSP) mode, the access point buffers incoming messages for the radio, which wakes up periodically and connects to the access point to see if any buffered messages are waiting. The radio requests buffered messages and then goes back to sleep. It conserves the most power but offers the lowest throughput. It is recommended when battery power is in use.
		Fast		Power Save Mode (Fast PSP) switches between the two modes described above, depending on network traffic. This mode switches to CAM when retrieving a large number of packets and switches back to PSP (= Power Save Polling) after the packets have been retrieved. It is recommended when power consumption is a concern but you need greater throughput than that allowed by Max PSP.
			▶ Default: Fast	
Bit Rate	The measurement of how much data is transmitted in a given amount of time from one location to another.			
	▶ Value: Auto (rate is negotiated automatically with the AP)			
	▶ Default: Auto			
Radio Mode	Use of 802.11a/b/g/n frequencies and data rates when interacting with an AP, or the use of ad hoc to associate to a station radio.			
	▶ Value: B rates only, BG rates full, G rates only, BG LRS, A rates only, ABG rates full, BGA rates full, Ad Hoc			
	B rates only	1, 2, 5.5, and 11 Mbps.		
	BG rates full	All B and G rates, plus N rates if supported.		
	G rates only	6, 9, 12, 18, 24, 36, 48, and 54 Mbps.		
	BG LRS	1, 2, 5.5, 6, 11, 24, 36, and 54 Mbps. This should only be used with Cisco APs running IOS in autonomous mode (without controllers).		

		<table border="1"> <tr> <td>A rates only</td> <td>6, 9, 12, 18, 24, 36, 48, and 54 Mbps, plus N rates if supported.</td> </tr> <tr> <td>ABG rates full</td> <td>All A rates and all B and G rates, with A rates (the 802.11a radio) preferred, plus N if supported.</td> </tr> <tr> <td>BGA rates full</td> <td>All B and G rates and all A rates, with B and G rates (the .11g radio) preferred, plus N rates if supported.</td> </tr> <tr> <td>Ad Hoc</td> <td>When selected, the Summit radio associates to another station radio that is in ad hoc mode and has the same SSID and, if configured, static WEP key.</td> </tr> </table> <p>▶ Default: ABG rates full</p>	A rates only	6, 9, 12, 18, 24, 36, 48, and 54 Mbps, plus N rates if supported.	ABG rates full	All A rates and all B and G rates, with A rates (the 802.11a radio) preferred, plus N if supported.	BGA rates full	All B and G rates and all A rates, with B and G rates (the .11g radio) preferred, plus N rates if supported.	Ad Hoc	When selected, the Summit radio associates to another station radio that is in ad hoc mode and has the same SSID and, if configured, static WEP key.
A rates only	6, 9, 12, 18, 24, 36, 48, and 54 Mbps, plus N rates if supported.									
ABG rates full	All A rates and all B and G rates, with A rates (the 802.11a radio) preferred, plus N if supported.									
BGA rates full	All B and G rates and all A rates, with B and G rates (the .11g radio) preferred, plus N rates if supported.									
Ad Hoc	When selected, the Summit radio associates to another station radio that is in ad hoc mode and has the same SSID and, if configured, static WEP key.									
Auth Type	<p>802.11 authentication type used when associating to an AP.</p> <ul style="list-style-type: none"> ▶ Value: Open, Shared (shared-key), LEAP (Network-EAP) ▶ Default: Open ▶ It is recommended that the default setting Open is selected. 									
WPA	<p>WPA and WPA2 support the same authentication methods and similar key management methods; the difference is mainly in area of encryption. WPA defines TKIP as the primary encryption method, while WPA2 defines AES-CCMP as the primary encryption method.</p> <ul style="list-style-type: none"> ▶ Value: None, WPA, WPA2 ▶ Default: None 									

	Encryption	<p>This specifies the type of key used to encrypt and decrypt transmitted data, and how that key is specified or derived. Select Encryption type in the Value drop-down box.</p> <table border="1" data-bbox="576 342 1348 987"> <thead> <tr> <th data-bbox="576 342 762 409">Item</th> <th data-bbox="762 342 1348 409">Description</th> </tr> </thead> <tbody> <tr> <td data-bbox="576 409 762 465">None</td> <td data-bbox="762 409 1348 465">N/A</td> </tr> <tr> <td data-bbox="576 465 762 544">TKIP</td> <td data-bbox="762 465 1348 544">The encryption method defined with WPA. TKIP uses RC4 encryption as does WEP.</td> </tr> <tr> <td data-bbox="576 544 762 656">AES-CCMP</td> <td data-bbox="762 544 1348 656">The encryption method defined with IEEE 802.11i and certified with WPA2. AES-CCMP is stronger than RC4</td> </tr> <tr> <td data-bbox="576 656 762 808">WEP</td> <td data-bbox="762 656 1348 808">The encryption method defined with the original IEEE 802.11 standards; encrypts transmitted data using 64-bit or 128-bit encryption.</td> </tr> <tr> <td data-bbox="576 808 762 987">CKIP</td> <td data-bbox="762 808 1348 987">CKIP is supported for use only with static WEP. For CKIP, encryption keys need to be defined in SCU; for CKIP-EAP, encryption keys are derived dynamically from an EAP authentication.</td> </tr> </tbody> </table>	Item	Description	None	N/A	TKIP	The encryption method defined with WPA. TKIP uses RC4 encryption as does WEP.	AES-CCMP	The encryption method defined with IEEE 802.11i and certified with WPA2. AES-CCMP is stronger than RC4	WEP	The encryption method defined with the original IEEE 802.11 standards; encrypts transmitted data using 64-bit or 128-bit encryption.	CKIP	CKIP is supported for use only with static WEP. For CKIP, encryption keys need to be defined in SCU; for CKIP-EAP, encryption keys are derived dynamically from an EAP authentication.	
Item	Description														
None	N/A														
TKIP	The encryption method defined with WPA. TKIP uses RC4 encryption as does WEP.														
AES-CCMP	The encryption method defined with IEEE 802.11i and certified with WPA2. AES-CCMP is stronger than RC4														
WEP	The encryption method defined with the original IEEE 802.11 standards; encrypts transmitted data using 64-bit or 128-bit encryption.														
CKIP	CKIP is supported for use only with static WEP. For CKIP, encryption keys need to be defined in SCU; for CKIP-EAP, encryption keys are derived dynamically from an EAP authentication.														
	Authentication	<p>This is the protocol used to authenticate the device and its user if the WLAN uses the Enterprise version of Wi-Fi Protected Access (WPA) and WPA2. Select Authentication type in the Value drop-down box, then enter the credentials necessary for each type in the appeared fields.</p> <table border="1" data-bbox="576 1167 1348 1984"> <thead> <tr> <th data-bbox="576 1167 794 1234">Item</th> <th data-bbox="794 1167 1348 1234">Description</th> </tr> </thead> <tbody> <tr> <td data-bbox="576 1234 794 1290">None</td> <td data-bbox="794 1234 1348 1290">N/A</td> </tr> <tr> <td data-bbox="576 1290 794 1413">LEAP</td> <td data-bbox="794 1290 1348 1413"> Credentials values for LEAP: <ul style="list-style-type: none"> ▶ User Name (up to 64 characters) ▶ Password (up to 32 characters) </td> </tr> <tr> <td data-bbox="576 1413 794 1872">EAP-FAST</td> <td data-bbox="794 1413 1348 1872"> Credentials values for EAP-FAST <ul style="list-style-type: none"> ▶ User Name (up to 64 characters) ▶ Password (up to 32 characters) ▶ PAC Filename (up to 32 characters): You may create a protected access credential (PAC) for each client device. When creating a PAC manually, you must store it in the directory identified in Certs Path on the Globals settings page. To use automatic provisioning, leave this field blank. ▶ PAC Password (up to 32 characters) </td> </tr> <tr> <td data-bbox="576 1872 794 1984">PEAP-MSCHAP</td> <td data-bbox="794 1872 1348 1984"> Credentials values for PEAP-MSCHAP, PEAP-GTC, EAP-TTLS: <ul style="list-style-type: none"> ▶ User Name (up to 64 characters) </td> </tr> </tbody> </table>	Item	Description	None	N/A	LEAP	Credentials values for LEAP: <ul style="list-style-type: none"> ▶ User Name (up to 64 characters) ▶ Password (up to 32 characters) 	EAP-FAST	Credentials values for EAP-FAST <ul style="list-style-type: none"> ▶ User Name (up to 64 characters) ▶ Password (up to 32 characters) ▶ PAC Filename (up to 32 characters): You may create a protected access credential (PAC) for each client device. When creating a PAC manually, you must store it in the directory identified in Certs Path on the Globals settings page. To use automatic provisioning, leave this field blank. ▶ PAC Password (up to 32 characters) 	PEAP-MSCHAP	Credentials values for PEAP-MSCHAP, PEAP-GTC, EAP-TTLS: <ul style="list-style-type: none"> ▶ User Name (up to 64 characters) 			
Item	Description														
None	N/A														
LEAP	Credentials values for LEAP: <ul style="list-style-type: none"> ▶ User Name (up to 64 characters) ▶ Password (up to 32 characters) 														
EAP-FAST	Credentials values for EAP-FAST <ul style="list-style-type: none"> ▶ User Name (up to 64 characters) ▶ Password (up to 32 characters) ▶ PAC Filename (up to 32 characters): You may create a protected access credential (PAC) for each client device. When creating a PAC manually, you must store it in the directory identified in Certs Path on the Globals settings page. To use automatic provisioning, leave this field blank. ▶ PAC Password (up to 32 characters) 														
PEAP-MSCHAP	Credentials values for PEAP-MSCHAP, PEAP-GTC, EAP-TTLS: <ul style="list-style-type: none"> ▶ User Name (up to 64 characters) 														

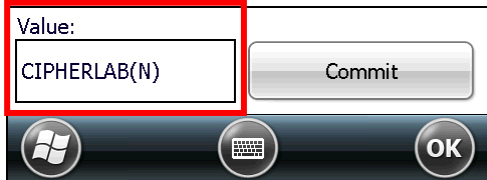
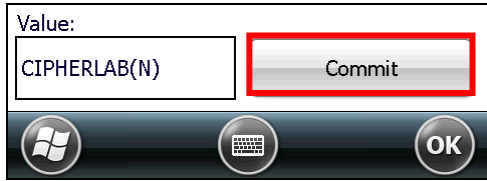
		<p>PEAP-GTC</p> <hr/> <p>EAP-TTLS</p> <hr/> <p>EAP-TLS</p> <hr/> <p>PEAP-TLS</p> <hr/> <p>PSK</p>	<ul style="list-style-type: none"> ▶ User Name (up to 64 characters) ▶ Password (up to 32 characters) ▶ CA Cert: Filename and extension of root certificate authority (CA) digital certificate (up to 32 characters). Specify the Certs Path in Globals settings page > Certs Path. <p>Credentials values for EAP-TLS and PEAP-TLS:</p> <ul style="list-style-type: none"> ▶ User: Username or Domain/Username (up to 64 characters) ▶ User Cert: Filename and extension of user certificate residing in the Microsoft certificate store. See View Secure Certificates. ▶ CA Cert: Filename and extension of root certificate authority (CA) digital certificate (up to 32 characters). Specify the Certs Path in Globals settings page > Certs Path. <p>Pre-shared keys (PSK) consist of up to 256 bits entered as a string of up to 64 hexadecimal digits.</p>
	<p>Fast Reauth</p>	<p>The expedited WPA key handshake used to reduce roaming time to 125 msec or less. Available for WPA TKIP and WPA2 AES-CCMP.</p> <ul style="list-style-type: none"> ▶ Value: None, CCKM ▶ Default: None 	
<p>Value</p>	<p>Use this box to change the value of a selected item. Depending on the item property, this can be done by choosing a value from a drop-down list, or entering the desired value with the on-screen or physical keypad.</p> 		
<p>Commit</p>	<p>After making any changes on the Profile tabbed page, the Commit button must be tapped in order for the settings to take effect.</p> 		

MANAGE GLOBAL SETTINGS

Global settings include radio and security settings that apply to all profiles in SCU.

To open the Global settings page:

- 1) Open SCU's Configuration tabbed page as described in [Create Wi-Fi Profile](#).
- 2) Tap **Manage Profiles** to open the Profile settings page.
- 3) Tap the **Globals** tab to open the Global settings page.

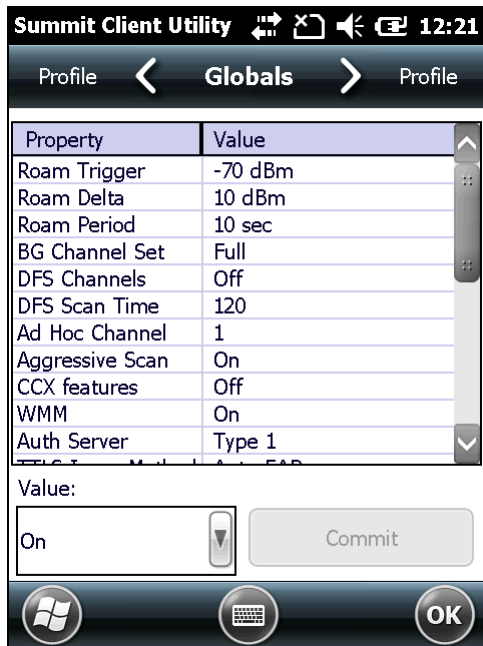

Property	Value						
Roam Trigger	<p>When the moving average RSSI from the current AP is weaker than Roam Trigger, radio does a roam scan where it probes for an AP with a signal that is at least Roam Delta dBm stronger.</p> <ul style="list-style-type: none"> ▶ Value (dBm): -50, -55, -60, -65, -70, -75, -80, -85, -90, Custom ▶ Default: -70 dBm 						
Roam Delta	<p>When Roam Trigger is met, a second AP's signal strength (RSSI) must be Roam Delta dBm stronger than the moving average RSSI for the current AP before radio will attempt to roam to the second AP.</p> <ul style="list-style-type: none"> ▶ Value (dBm): 5, 10, 15, 20, 25, 30, 35 ▶ Default: 10 dBm 						
Roam Period	<p>After association or roam scan (with no roam), radio will collect RSSI scan data from Roam Period seconds before considering roaming.</p> <ul style="list-style-type: none"> ▶ Value (sec): 5, 10, 15, 20, 25, 30, 35, 40, 45, 50, 55, 60, Custom ▶ Default: 10 (seconds) 						
BG Channel Set	<p>Defines the 2.4 GHz channels to be scanned when the radio is contemplating a roam and needs to determine what APs are available.</p> <table border="1" style="width: 100%;"> <thead> <tr> <th>Item</th> <th>Description</th> </tr> </thead> <tbody> <tr> <td>Full</td> <td>All channels</td> </tr> <tr> <td>1, 6, 11</td> <td>The most commonly used 2.4 GHz channels</td> </tr> </tbody> </table>	Item	Description	Full	All channels	1, 6, 11	The most commonly used 2.4 GHz channels
Item	Description						
Full	All channels						
1, 6, 11	The most commonly used 2.4 GHz channels						

	<table border="1"> <tr> <td>1, 7, 13</td> <td>For ETSI and TELEC radios only</td> </tr> <tr> <td>Custom</td> <td>Indicates the system registry has been edited to include a value other than those available in the drop-down value</td> </tr> </table> <ul style="list-style-type: none"> ▶ Default: Full 	1, 7, 13	For ETSI and TELEC radios only	Custom	Indicates the system registry has been edited to include a value other than those available in the drop-down value
1, 7, 13	For ETSI and TELEC radios only				
Custom	Indicates the system registry has been edited to include a value other than those available in the drop-down value				
DFS Channels	<p>Indicates whether to support 5 GHz (802.11a) channels where dynamic frequency selection (DFS) is required.</p> <ul style="list-style-type: none"> ▶ Value: On, Off ▶ Default: Off 				
DFS Scan Time	<p>Enables determining the dwell (listen) time when passively scanning on a DFS channel.</p> <ul style="list-style-type: none"> ▶ Valid range of 20-500 ms configurable ▶ Default: 120 ▶ When the DFS Scan Time is changed to a value lower than default, it is recommended that the beacon period in the WLAN infrastructure is changed as well. Ideally, the dwell time should be 1.5 times than that of the beacon period. 				
Ad Hoc Channel	<p>The channel to be used for an ad hoc connection if the active profile has a Radio Mode value of "Ad Hoc".</p> <ul style="list-style-type: none"> ▶ Value: <table border="1"> <tr> <td>1~14</td> <td>One of the 2.4 GHz channels</td> </tr> <tr> <td>36, 40, 44, 48</td> <td>UNII-1 channels</td> </tr> </table> ▶ Default: 1 ▶ If a channel that is not supported is selected, then SCU will automatically apply the default channel setting (1). 	1~14	One of the 2.4 GHz channels	36, 40, 44, 48	UNII-1 channels
1~14	One of the 2.4 GHz channels				
36, 40, 44, 48	UNII-1 channels				
Aggressive Scan	<p>Aggressive scanning complements and works in conjunction with the standard scanning that is configured through the Roam Trigger, Roam Delta, and Roam Period settings. It is recommended that aggressive scanning is enabled unless there is significant co-channel interference because of overlapping coverage from APs that are on the same channel.</p> <ul style="list-style-type: none"> ▶ Value: On, Off ▶ Default: On 				
CCX features	<p>Whether to allow the use of Cisco information element (IE) and CCX version number to authorize support for CCX features.</p> <ul style="list-style-type: none"> ▶ Value: Full, Off <p>Full mode uses Cisco IE and CCX version number and enables support for all CCX features. Off mode disables all support for Cisco IE and CCX version number.</p> <ul style="list-style-type: none"> ▶ Default: N/A ▶ If the radio fails to connect to an 802.11n wireless network, set CCX features as "Off" and try again. 				
WMM	<p>Whether to allow the use of Wi-Fi Multimedia (WMM) Extensions or not.</p> <ul style="list-style-type: none"> ▶ Value: On, Off ▶ Default: Off ▶ Changing this setting requires suspend/resume of the mobile computer to take effect. 				

Auth Server	<p>Type of authentication server being used for EAP authentication.</p> <ul style="list-style-type: none"> ▶ Value: <table border="1" data-bbox="512 309 1382 517"> <tr> <td data-bbox="512 309 823 416">Type 1</td> <td data-bbox="823 309 1382 416">Cisco Secure ACS or another server that uses PEAPv1 for PEAP with EAP-MSCHAPV2 (PEAP-MSCHAP)</td> </tr> <tr> <td data-bbox="512 416 823 517">Type 2</td> <td data-bbox="823 416 1382 517">A different authentication server, such as Juniper Networks Steel Belted RADIUS, that uses PEAPv0 for PEAP-MSCHAP</td> </tr> </table> ▶ Default: Type 1 	Type 1	Cisco Secure ACS or another server that uses PEAPv1 for PEAP with EAP-MSCHAPV2 (PEAP-MSCHAP)	Type 2	A different authentication server, such as Juniper Networks Steel Belted RADIUS, that uses PEAPv0 for PEAP-MSCHAP								
Type 1	Cisco Secure ACS or another server that uses PEAPv1 for PEAP with EAP-MSCHAPV2 (PEAP-MSCHAP)												
Type 2	A different authentication server, such as Juniper Networks Steel Belted RADIUS, that uses PEAPv0 for PEAP-MSCHAP												
TTLS Inner Method	<p>Authentication method used within secure tunnel created by EAP-TTLS.</p> <ul style="list-style-type: none"> ▶ Value: <table border="1" data-bbox="512 645 1382 927"> <tr> <td data-bbox="512 645 823 689">Auto-EAP</td> <td data-bbox="823 645 1382 689">Any available EAP method</td> </tr> <tr> <td data-bbox="512 689 823 734">MSCHAPV2</td> <td data-bbox="823 689 1382 734"></td> </tr> <tr> <td data-bbox="512 734 823 779">MSCHAP</td> <td data-bbox="823 734 1382 779"></td> </tr> <tr> <td data-bbox="512 779 823 824">PAP</td> <td data-bbox="823 779 1382 824"></td> </tr> <tr> <td data-bbox="512 824 823 869">CHAP</td> <td data-bbox="823 824 1382 869"></td> </tr> <tr> <td data-bbox="512 869 823 927">EAP-MSCHAPV2</td> <td data-bbox="823 869 1382 927"></td> </tr> </table> ▶ Default: Auto-EAP 	Auto-EAP	Any available EAP method	MSCHAPV2		MSCHAP		PAP		CHAP		EAP-MSCHAPV2	
Auto-EAP	Any available EAP method												
MSCHAPV2													
MSCHAP													
PAP													
CHAP													
EAP-MSCHAPV2													
PMK Caching	<p>The type of Pairwise Master Key (PMK) caching to use with a WPA2 encryption type (alternative to WPA2 CCKM).</p> <ul style="list-style-type: none"> ▶ Value: Standard or OPMK (opportunistic PMK) ▶ Default: Standard 												
TX Diversity	<p>How to handle antenna diversity when transmitting data to AP.</p> <ul style="list-style-type: none"> ▶ Value: <table border="1" data-bbox="512 1198 1382 1341"> <tr> <td data-bbox="512 1198 823 1243">Main Only</td> <td data-bbox="823 1198 1382 1243">Use main antenna only</td> </tr> <tr> <td data-bbox="512 1243 823 1288">Aux Only</td> <td data-bbox="823 1243 1382 1288">Use auxiliary antenna only</td> </tr> <tr> <td data-bbox="512 1288 823 1341">On</td> <td data-bbox="823 1288 1382 1341">Use diversity</td> </tr> </table> ▶ Default: On 	Main Only	Use main antenna only	Aux Only	Use auxiliary antenna only	On	Use diversity						
Main Only	Use main antenna only												
Aux Only	Use auxiliary antenna only												
On	Use diversity												
RX Diversity	<p>How to handle antenna diversity when receiving data from AP.</p> <ul style="list-style-type: none"> ▶ Default: On-start on Main ▶ This is a fixed setting; on startup, the main antenna is always used 												
Frag Thresh	<p>When packet size exceeds the set threshold, it becomes fragmented.</p> <ul style="list-style-type: none"> ▶ Value: 256 ~ 2346 ▶ Default: 2346 (bytes) 												
RTS Thresh	<p>When packet size exceeds the set threshold, RTS/CTS is required on link.</p> <ul style="list-style-type: none"> ▶ Value: 0 ~ 2347 ▶ Default: 2347 (bytes) 												
LED	<p>Indicates whether or not an LED is used.</p> <ul style="list-style-type: none"> ▶ Value: On, Off ▶ Default: Off 												
Tray Icon	<p>Whether to enable the system tray icon or not.</p> <ul style="list-style-type: none"> ▶ Value: On, Off ▶ Default: On 												

Admin Password	N/A
Auth Timeout (s)	<p>Specifies how long it will wait for an EAP authentication request to succeed or fail. If authentication credentials are specified in the active profile and the authentication times out, then association will fail. If authentication credentials are not specified in the active profile and the authentication times out, then the user will be required to enter credentials again.</p> <ul style="list-style-type: none"> ▶ Value: 3 ~ 60 ▶ Default: 8 (seconds)
Certs path	<p>File path where the certificate for EAP authentication is stored.</p> <ul style="list-style-type: none"> ▶ Value: A valid directory path of up to 64 characters ▶ Default: Depends on device
Supplicant	<p>The user (client) making a request to gain access to system resources through the authentication server.</p> <ul style="list-style-type: none"> ▶ Value: Summit, Third Party ▶ Default: Summit
Auto Profile	<p>Activate or deactivate automatic profile selection.</p> <ul style="list-style-type: none"> ▶ Value: On, Off ▶ Default: Off <p>When On is selected, proceed to the Profile settings page and select from the existing profiles those which you would like to add to the Auto Profile list. The number of profiles in this list is limited to 19.</p> <p>When Auto Profile is activated, the Summit radio will attempt to associate to an access point after a device startup or resume, and it will try out each listed profile in order until the radio associates to an access point. The successful profile becomes the active profile and remains active until one of the following occurs:</p> <ul style="list-style-type: none"> ▶ The device goes through suspension and resume, power-cycling, or restart, which causes the radio to go through the automatic profile selection process once more. ▶ Auto Profile is turned off and an active profile is manually selected on the SCU Configuration tab.

5.2.4. DIAGNOSTICS TABBED PAGE

Perform diagnostic tests to troubleshoot connection issues when necessary.

To open the Diagnostics page:

- 1) Open SCU as described in [Launch SCU](#).
- 2) Tap the **Diagnostics** tab to show the Diagnostics page.

Diagnostics status for Wi-Fi and Bluetooth shows, along with on-screen buttons to open Advanced settings and view software version information.

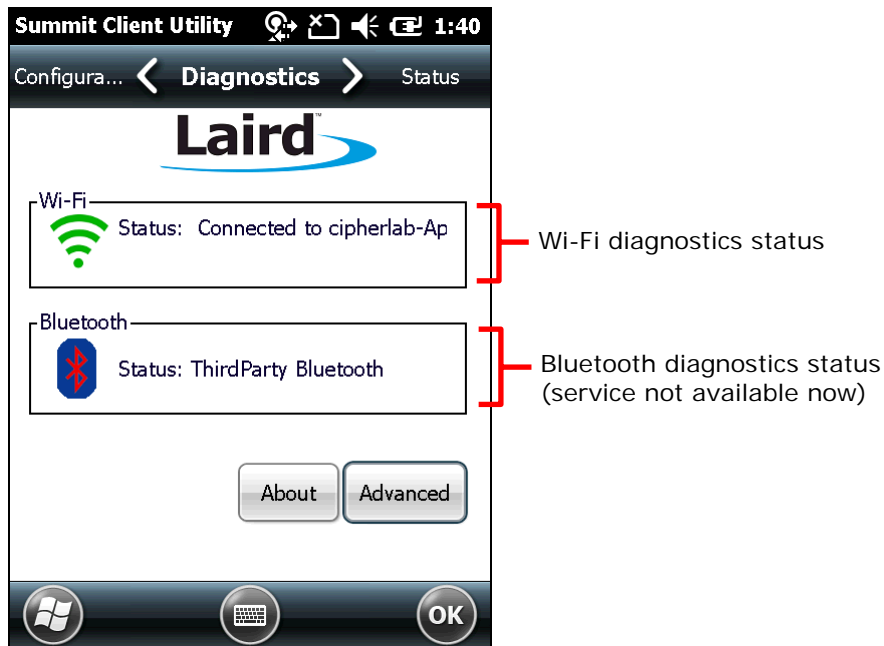

ADVANCED DIAGNOSTICS

To access Advanced diagnostics settings:

- 1) Open [Diagnostics Tabbed Page](#).
- 2) Tap the **Advanced** button to open advanced diagnostics settings.



CHECK STATUS

To check diagnostics status, select **Status** in the drop-down bar.

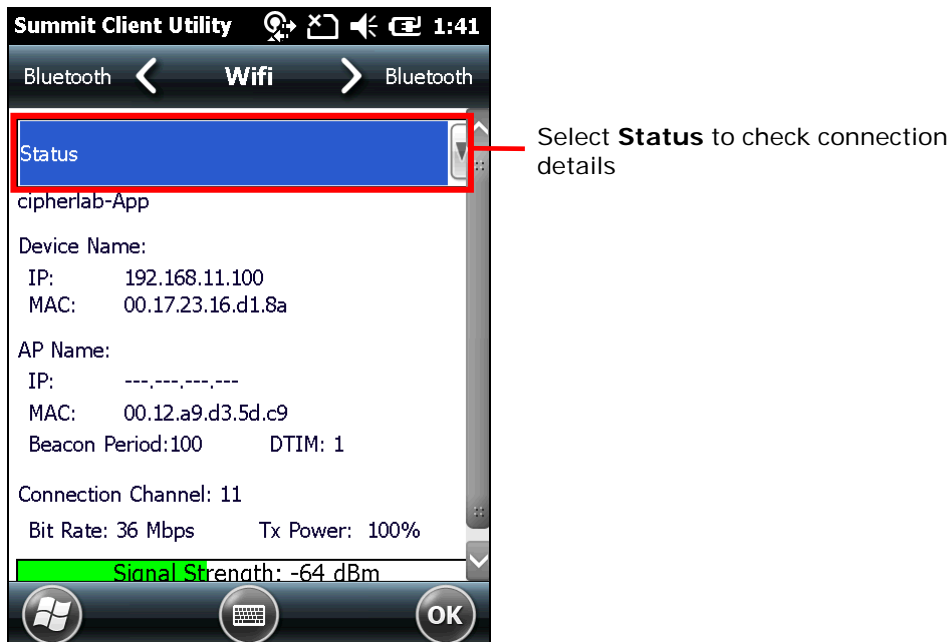

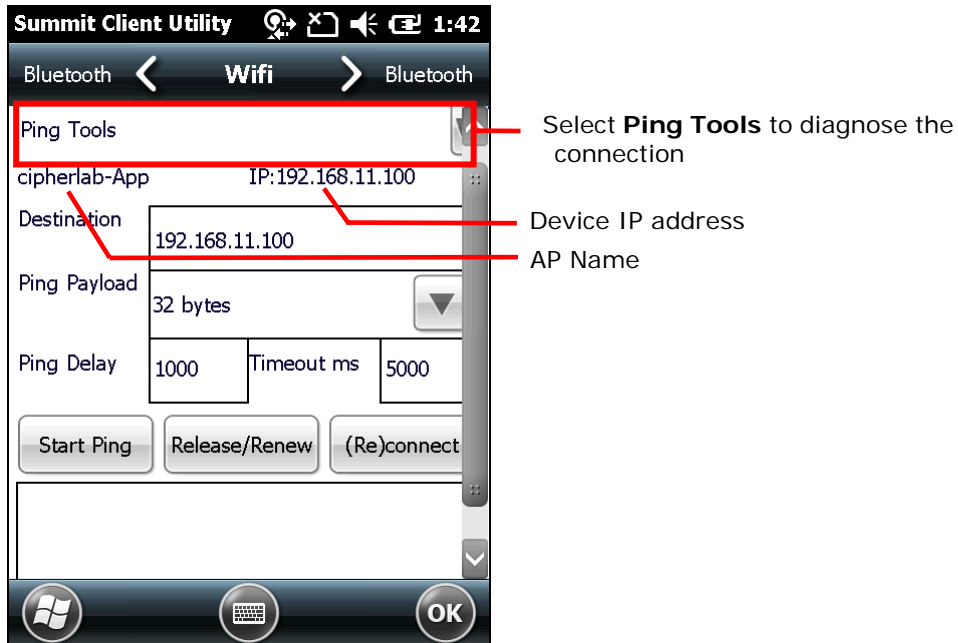

USE PING TOOLS

To perform ping tests, select **Ping Tools** in the drop-down bar.

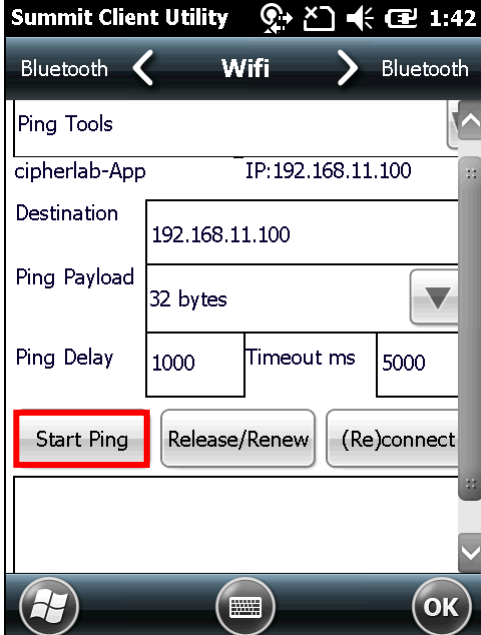

Item	Description
Destination	Enter the address to ping.
Ping Payload	The amount of data to be transmitted on a ping. <ul style="list-style-type: none"> ▶ Value: 32, 64, 128, 256, 512, 1024 ▶ Default: 32 (bytes)
Ping Delay	The amount of time that elapses between successive ping requests. <ul style="list-style-type: none"> ▶ Value: 0~7200000 ▶ Default: 1000 (milliseconds)
Timeout ms	The amount of time that elapses without a response before ping request is considered a failure. <ul style="list-style-type: none"> ▶ Value: 0~30000 ▶ Default: 5000 (milliseconds)
Start Ping	Enter the address to ping to in the Destination field and tap Start Ping . A continuous ping will begin until the following happens: Stop Ping is tapped, the application is exited, or the radio is removed. Activity status will be logged in the output box below.

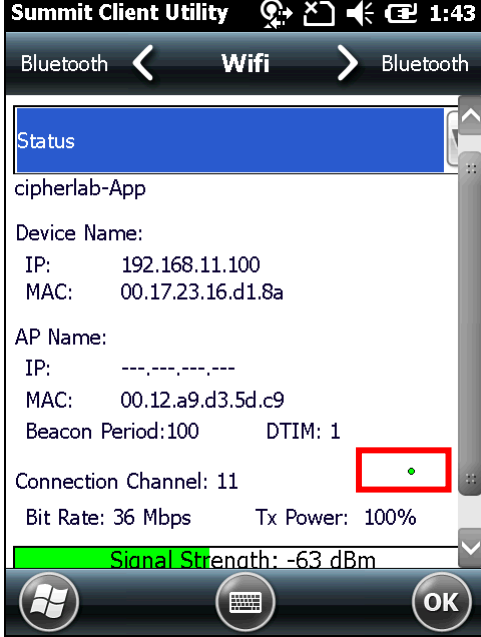
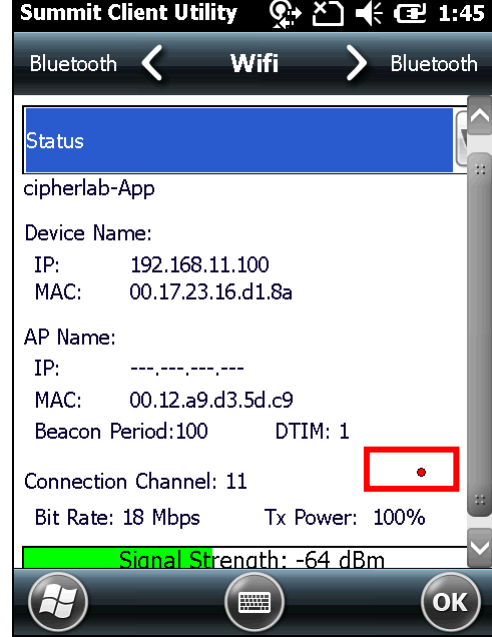
<p>Start Ping</p>		
<p>When an active ping is initiated, the screen displays a ping indicator that blinks in green (for a successful ping) or red (for an unsuccessful ping). The ping indicator is hidden when the screen is switched to a tab other than Diags or Status.</p>		
<p>Release/Renew</p>		
<p>Release/Renew</p>	<p>Obtain a new IP address through DHCP release/renew, and log all activity in the output area at the bottom.</p>	

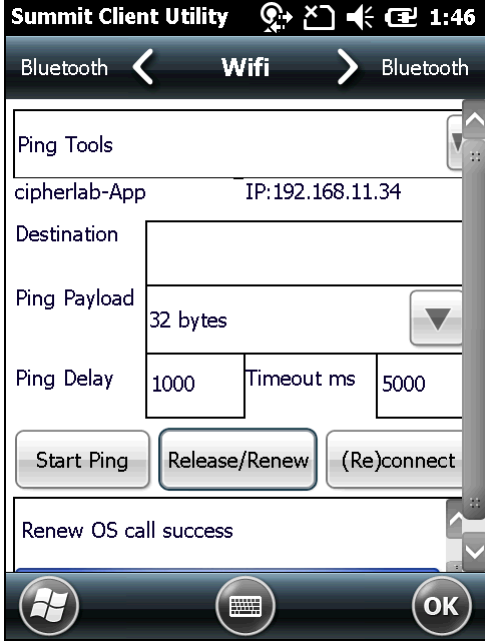
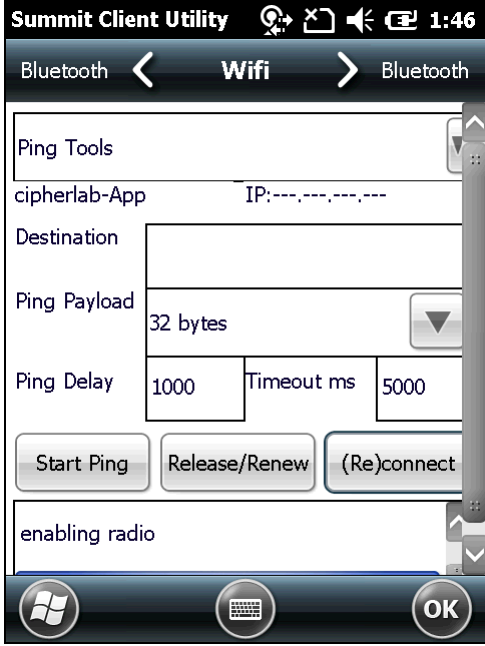
	
(Re)connect	<p>Disable and enable the radio, apply or re-apply the current profile, attempt to associate and authenticate to the wireless network, and log all activity in the output area at the bottom.</p> 

USE DEBUG TOOLS

To check debug settings, select **Debug** in the drop-down bar.

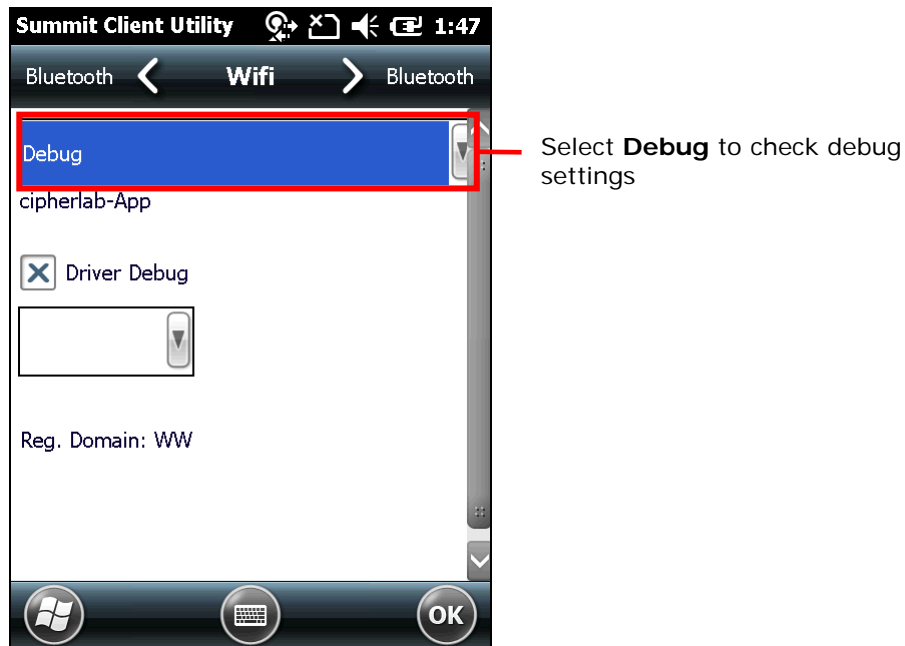

Item	Description
Driver Debug	<p>Select whether to debug the WLAN driver, and the output mode for driver debug.</p> <ul style="list-style-type: none"> ▶ Value: Not set, 1-Text(Low), 2-Text, 3-Text(High), 4-Serial(Low), 5-Serial, 6-Serial(High) ▶ Default: Not set ▶ When set as 1-Text(Low), 2-Text, or 3-Text(High), SCU will continue to export debug logs to the mobile computer's internal storage. Do not select any of these options unless necessary.
Reg. Domain	<p>Indicates the regulatory domain or domains for which the radio is configured by default. Default setting is "Worldwide", which means that the radio can be used in any domain.</p>

Note: It is recommended that Driver Debug output settings are kept as default and not changed.

SOFTWARE VERSION INFORMATION

To check software version information:

- 1) Open [Diagnostics Tabbed Page](#).
- 2) Tap the **About** button to view information about SCU version, device driver, and software developer.

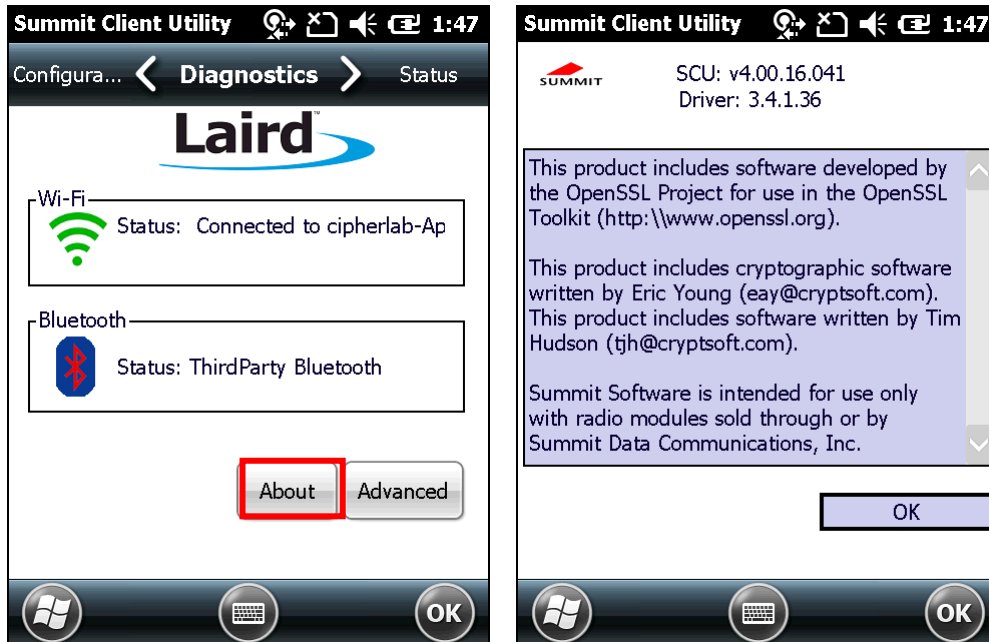

5.3. USE BLUETOOTH



The mobile computer is Bluetooth-enabled to synchronize data with other devices such as PCs, car hands-free kits, headsets, printers, PDAs, and cell phones.

Class II Bluetooth devices enable wireless connections over a short distance of around 10 meters. It is specified in IEEE 802.15.1 as a “wireless personal area network” (WPAN).

To connect a Bluetooth device for the first time, the mobile computer needs to “pair” with it. Such “pairing” involves authentication between two devices to justify their accesses to each other. After this initial pairing, the two devices can connect to each other without a second pairing procedure.

5.3.1. STATUS ICONS

According to the Bluetooth connection status, the following status icons will appear on the title bar:

Status Icon	Description
	Bluetooth in use (data transmission ongoing)
	Bluetooth headset in use

5.3.2. CHANGE BLUETOOTH NAME

By default, the mobile computer uses the device name for its Bluetooth name. Change the device name to make it more recognizable.

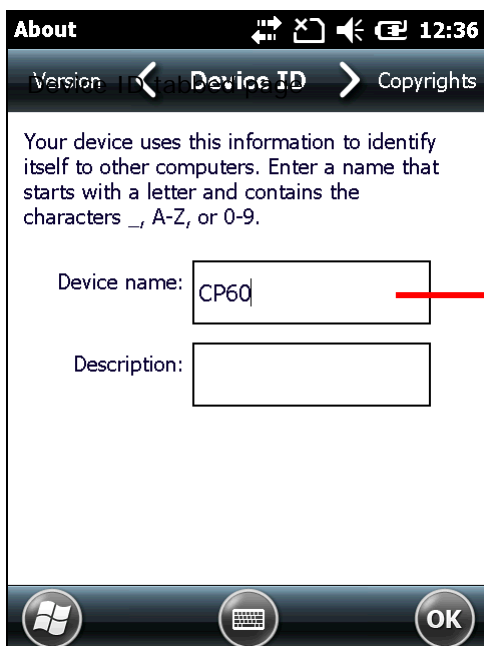

Change device name to make the mobile computer more recognizable.

To change the mobile computer’s device name:

- 1) On Start screen, tap **Settings** | **System** | **About**  .
About screen opens showing Version tabbed page.
- 2) Tap **Device ID** tab.

Device ID tabbed page opens.

- 3) Enter a name following the prompted rule.
- 4) Tap the "OK" command on the softkey bar to apply the change.

5.3.3. TURN ON/OFF BLUETOOTH

To turn on/off Bluetooth power:

- 1) On Start screen, tap **Settings** | **Connections** | **Wireless Manager** .

Wireless Manager opens.
- 2) Tap the **Bluetooth** entry.

Bluetooth power is switched on.

To turn off Bluetooth power, simply tap the **Bluetooth** entry again.

OR

- 1) On Start screen, tap **Settings** | **Bluetooth** .

Bluetooth settings opens showing **Devices** tabbed page.
- 2) Tap **Mode** tab.

Mode tabbed page opens.
- 3) Select **Turn on Bluetooth**.
- 4) Tap the **OK** command on the softkey bar.

Bluetooth powers on.

To turn off Bluetooth power, simply deselect **Turn on Bluetooth** and tap **OK** to apply the change.

5.3.4. EXPOSE MOBILE COMPUTER

In default state, the mobile computer is hidden from other Bluetooth devices. To allow other devices to be able to find mobile computer, set the mobile computer as follows:

- 1) On Start screen, tap **Settings** | **Bluetooth** .

Bluetooth settings open showing **Devices** tabbed page.
- 2) Tap **Mode** tab.

Mode tabbed page opens.
- 3) Check Turn on Bluetooth and **Make this device visible to other devices**.

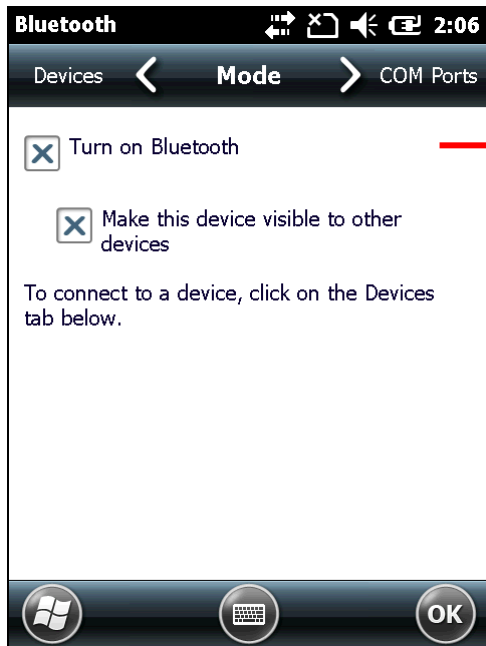

Select **Turn on Bluetooth** and **Make this device visible to other devices**.

- 4) Tap the **OK** command on the softkey bar.

Once set, the mobile computer becomes discoverable by other Bluetooth devices.

When **Settings | Connections | Wireless Manager** is opened, a "Visible" label appears under Bluetooth entry.



Bluetooth entry shows a "Visible" label on Wireless Manager screen.

5.3.5. PAIR & CONNECT BLUETOOTH DEVICES

Prior to connecting to another Bluetooth device, the mobile computer needs to pair with that device. Once they are paired, the two devices will stay paired unless they are unpaired.

To pair with and connect to a Bluetooth device:

- 1) On the mobile computer, turn on Bluetooth as described in [Turn On/Off Bluetooth](#).
- 2) On Start screen, tap **Settings** | **Bluetooth** .

Bluetooth settings open showing **Devices** tabbed page.

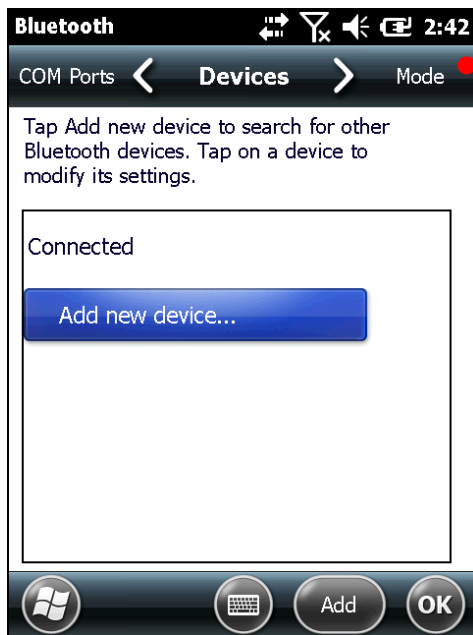

Devices tabbed page under Bluetooth settings

- 3) Tap **Add new device...**

The mobile computer scans and displays the names of all Bluetooth devices found within reach.

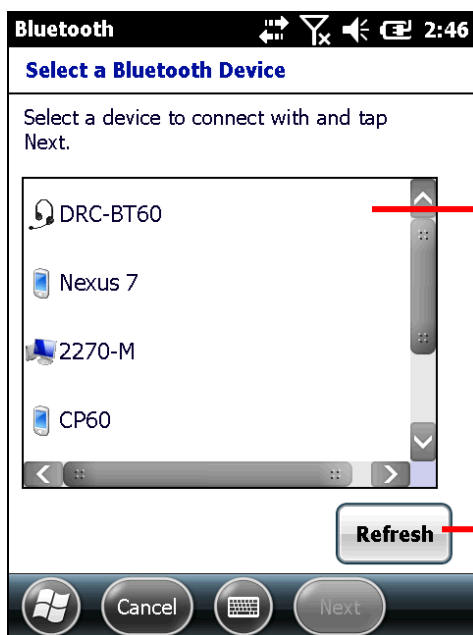

Bluetooth scanning results

Tap to scan again

If the device to pair with is not displayed, make sure it is currently set as discoverable. If the mobile computer stops scanning before that device becomes discoverable, tap **Refresh** to repeat the scan

- 4) Tap the name of the found device that you wish to connect. Tap **Next**.

The two devices pair with each other. You may be asked for a passcode for a secure connection. Try entering "0000" or '1234" (the most common passcodes). On some occasions you may need to refer to the documentation of the Bluetooth device to obtain this code.

Once the device is paired (and connected), you are prompted by a dialog indicating that the connection is established.



Bluetooth device paired and connected

- 5) Tap **Done** on the softkey bar.

OR

Tap the **Advanced** command on the softkey bar to configure the Bluetooth features to use with that device. Then tap **Save**.



Devices tabbed page re-opens listing the newly connected Bluetooth device among others.

A connected device is listed under **Connected** label. A paired but unconnected device is listed under **Disconnected** label.

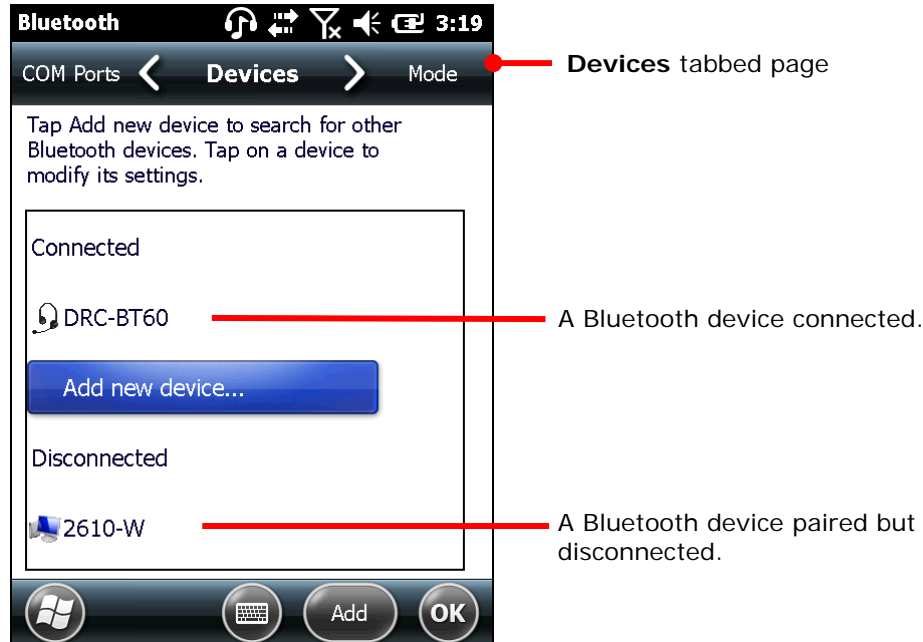

- 6) Tap and hold a connected device to edit its Bluetooth features to use, disconnect it or delete (unpair) it.

OR

Tap and hold a disconnected device to edit its Bluetooth features to use, reconnect it, or delete (unpair) it.

5.3.6. DISCONNECT BLUETOOTH DEVICES

To disconnect the mobile computer from a Bluetooth device, there are two approaches:

Simply turn off the Bluetooth as described in [Turn On/Off Bluetooth](#). The mobile computer is disconnected from all connected Bluetooth devices.

OR

- 1) Open Bluetooth settings by tapping Start screen | **Settings** | **Bluetooth**, or Start screen | **Settings** | **Connections** | **Wireless Manager** | Menu on softkey bar | **Bluetooth Settings**.

Bluetooth settings open showing **Devices** tabbed page.

- 2) Tap and hold the device to disconnect from.

Context menu opens.

- 3) Tap **Disconnect**.

The mobile computer is disconnected from the Bluetooth device.

5.3.7. UNPAIR BLUETOOTH DEVICES

To unpair a Bluetooth device:

- 1) Open Bluetooth settings by tapping **Start screen** | **Settings** | **Bluetooth**.
Bluetooth settings open showing **Devices** tabbed page.
- 2) Tap and hold the device to unpair from.
Context menu opens.
- 3) Tap **Delete**.
The Bluetooth device is unpaired. The mobile computer needs to pair with it again to reconnect to it.

5.3.8. RECONNECT BLUETOOTH DEVICES

Before the mobile computer reconnects to a Bluetooth device, make sure the two devices are paired and placed within each other's wireless reach.

To reconnect to a Bluetooth device:

- 1) Open Bluetooth settings by tapping **Start screen** | **Settings** | **Bluetooth**.
Bluetooth settings open showing **Devices** tabbed page.
- 2) Tap and hold the device to reconnect (normally it will be under **Disconnected** label).
Context menu opens.
- 3) Tap **Connect**.
The Bluetooth device is reconnected and its name displays under **Connected** label.

5.3.9. EDIT BLUETOOTH FEATURES TO USE

A Bluetooth profile defines the features and communications supported by a Bluetooth device. For two Bluetooth devices to share files with each other, they need to both support the due profiles. Some Bluetooth devices have multiple profiles. Profiles can cover the ability to play music in stereo, to transfer files or other data and more. The mobile computer enables configuring the profiles you want to use on the mobile computer.

- 1) Open Bluetooth settings. (Start screen | **Settings** | **Bluetooth**.)
Bluetooth settings open showing **Devices** tabbed page.
- 2) Tap and hold the device to configure.
Context menu opens.
- 3) Tap **Edit**.

Partnership Settings opens listing the device's available profiles.

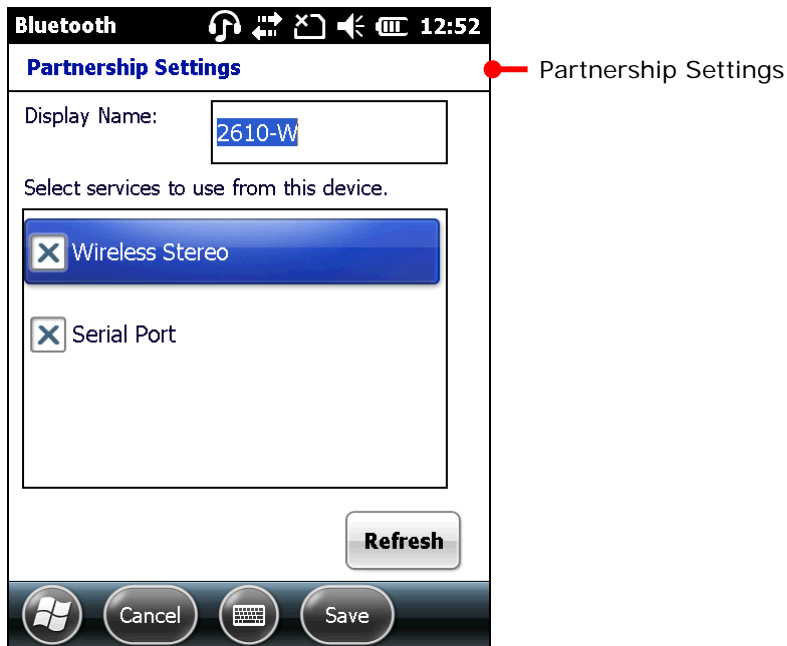

- 4) Select or deselect a profile to use it or not.

5.3.10. BLUETOOTH FILE EXCHANGE

Once connected with other devices using Bluetooth, the mobile computer can offload or download files to/from them. Basically it relies on File Explorer  to get it done.

OFFLOAD FILES

- 1) On the mobile computer, turn on Bluetooth as described in [Turn On/Off Bluetooth](#) if you haven't.
- 2) Open File Explorer .
- 3) Browse to the file to offload.
- 4) Tap and hold the file to offload.
Context menu comes up.
- 5) Tap **Beam File...**

The Bluetooth application generates a list of Bluetooth devices found.

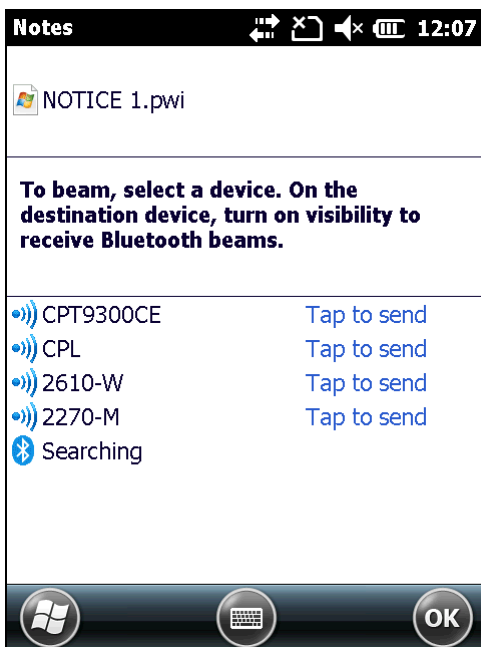

- 6) Select the device to offload the file to.
The device will receive a notification asking for confirmation to accept the file.
- 7) Confirm accept.
The device proceeds to receive it inbound.

DOWNLOAD FILES

For the mobile computer to download files from other devices using Bluetooth, “Beam mode” must be enabled first:

To enable Beam mode:

- 1) On Start screen, tap **Settings | Connections | Beam** .
- 2) Select **Receive all incoming beams**.

To download files from other devices using Bluetooth:

- 3) Enable the mobile computer’s “Beam” as mentioned above.
- 4) Turn on Bluetooth as described in [Turn On/Off Bluetooth](#) if you haven’t.
- 5) Make the mobile computer discoverable as mentioned in [Expose Mobile Computer](#).

The mobile computer readies to receive an inbound file with Bluetooth. The mobile computer asks if you what to accept the file when it is coming in.

- 6) Confirm **Yes** or **No**.

The file is saved to the mobile computer or rejected.

5.3.11. BLUETOOTH ACTIVESYNC

The advantage of Bluetooth ActiveSync is to save the trouble perpetually switching between multiple devices by changing cables or adapters.

Note to disable network bridging on your PC (specifically bridging to a Remote NDIS adapter) before connecting Bluetooth ActiveSync. For more information on network bridging, see Windows Help on the PC.

To use ActiveSync using Bluetooth:

- 1) Note the virtual Bluetooth COM port on your PC. If your PC doesn’t have any, add one.
- 2) Run ActiveSync on your PC. From the menu bar, click **File | Connection Settings**.
- 3) Deselect **Allow USB connection** and select **Allow connections to one of the following**.
- 4) Select the COM port you noted in step 1.
- 5) Press OK button to apply change and quit setting.
- 6) On the mobile computer, tap **ActiveSync**  from Start screen.

ActiveSync opens. If this is your first time opening it, it shows some guidelines to set up sync. Proceed as described in the following.

- 7) Tap the “Menu” command on the softkey bar.

Option menu opens.

- 8) Tap **Connect via Bluetooth**.

For 1st setup, you are prompted to set up Bluetooth partnership with your PC.

- 9) Tap **Yes** in the popup dialog inquiring if a partnership should be set up.

You are taken to Bluetooth’s Mode tabbed page.

- 10) Turn on Bluetooth if you haven’t.
- 11) Tap **Device** tab.

Bluetooth's Device tabbed page open.

- 12) For the 1st setup, tap **Add new device** and complete through pairing and connection as described in [Pair & Connect Bluetooth Devices](#).

OR

Select the name of your PC if it is connected before.

Once paired and/or connected, you are taken back to Device tabbed page.

- 13) Reopen **ActiveSync**  on the mobile computer.
- 14) Tap the "Menu" command on the softkey bar on the softkey bar.

Option menu opens.

- 15) Tap **Connect via Bluetooth**.

Bluetooth connection is established within a few seconds. ActiveSync on your PC opens its **Sync Setup Wizard**.

- 16) Set up the sync partnership you desire. See [1st USB Sync](#) for the setting.

DISCONNECT BLUETOOTH ACTIVESYNC

To disconnect Bluetooth ActiveSync:

- 1) On the mobile computer, tap **ActiveSync**  from Start screen.
ActiveSync opens.
- 2) Tap the "Menu" command on the softkey bar.
Option menu opens.
- 3) Tap **Disconnect**.
Bluetooth ActiveSync is disconnected.

5.3.12. BLUETOOTH INTERNET SHARING

As mentioned in [USB Internet Sharing](#), “Internet Sharing” or “Internet Tethering” enables a Windows-based PC to connect to Internet using the mobile computer’s mobile data (or other dial-up). Well “Internet Sharing” is supported by Bluetooth too. To tether to Internet using Bluetooth, make the follow setting:

- 1) Set up Bluetooth connection between the mobile computer and your PC as described in [Pair & Connect Bluetooth Devices](#).
- 2) On the mobile computer, tap **Internet Sharing**  from Start screen.

Internet Sharing opens.

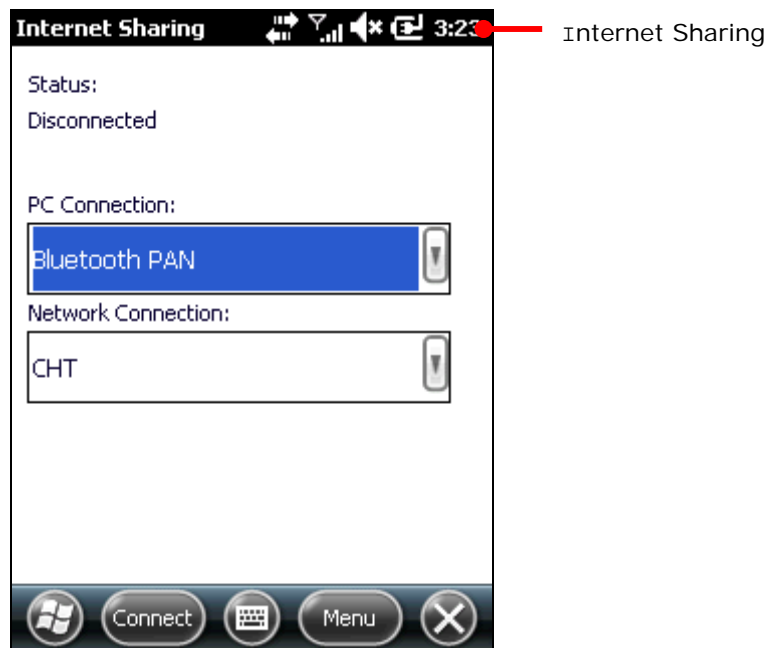

- 3) Select **Bluetooth PAN** for **PC Connection**, and select your wireless service for **Network Connection**.
- 4) Tap the “Connect” command on the softkey bar.
- 5) On your PC, set up a **Bluetooth Personal Area Network** with the mobile computer.

Setting up a Bluetooth PAN varies between different Bluetooth utilities. Consult the documentation of your Bluetooth utility or Windows Help on your PC to know about the setup.

In a few seconds Internet Sharing prompts “Connected” on the mobile computer. Your PC connects to Internet.

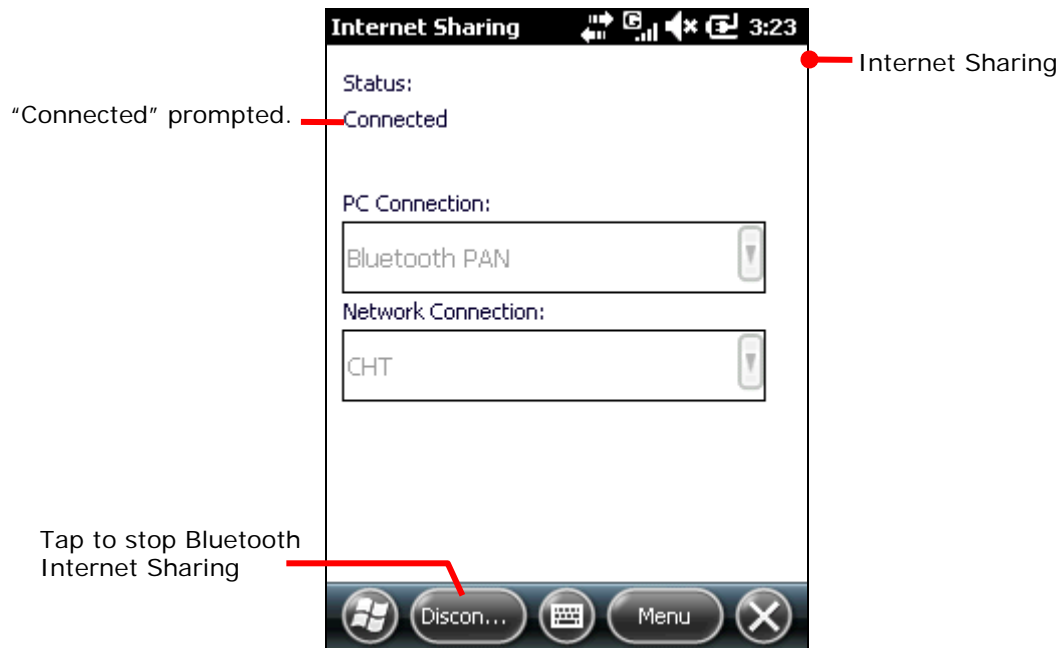

Tap the "Discon..." command on the softkey bar to stop.

For the internet sharing using USB, see [USB Internet Sharing](#).

5.3.13. BLUETOOTH PASS-THROUGH NETWORKING

"Pass-Through Networking" enables the mobile computer to network using your PC's data connection, courtesy that two computers are synced, whether by a hardwired USB approach or wirelessly by Bluetooth.

- 1) Establish sync partnership between the mobile computer and your PC using Bluetooth as described in [Bluetooth ActiveSync](#).
- 2) On your PC, from the menu bar of ActiveSync, select **File | Connection Settings**.
Connection Settings open.
- 3) For **This computer is connected to**, select a connection to which your PC should connect when passing through ActiveSync.
- 4) Select **Open ActiveSync when my device connects**.
- 5) Press **OK** button to apply the change and quit settings.

You can proceed to network connection on the mobile computer.

For the pass-through networking with USB, see [USB Pass-through Networking](#).

5.4. CONNECT TO VIRTUAL PRIVATE NETWORK

Virtual Private Networks (VPN) are a group of individual networks on a public network (such as the Internet) that connect to each other by private lines and communicate among themselves by encryption technology so their data are kept safe from unauthorized access. The mobile computer supports VPN connection to access the resources inside a secured network from the outside.

There are a variety of security protocols for VPN. Some of them work based on secure certificates while others require passwords to permit access. To access a VPN with secure certificates, see [Install Secure Certificates](#).

To be able to set up a VPN connection on the mobile computer, obtain the necessary credentials from your network administrator, and also note VPN is always accessed via mobile data connection, i.e. the mobile computer's HSPA+ data transfer.

5.4.1. VPN CONNECTION SETUP

To add a VPN connection to the mobile computer:

- 1) On Start screen, tap **Settings | Connections | Connections** (Manager) .

Connections (Manager) opens showing Tasks tabbed page.

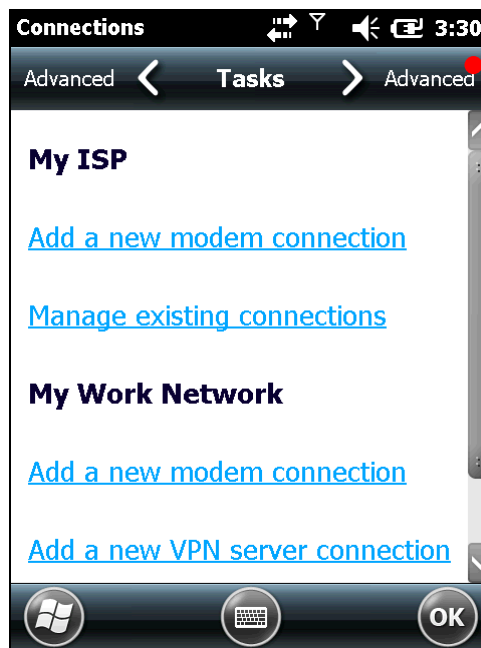

Connections (Manager) opens showing Tasks tabbed page.

- 2) Under **My Work Network** label, tap **Add a new VPN server connection**.

“Make New Connection” page opens.

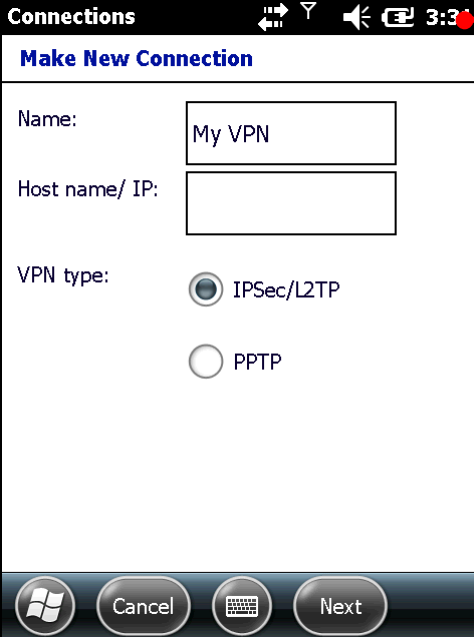

The screenshot shows a mobile application interface for creating a new VPN connection. The title bar at the top reads "Connections" and "Make New Connection". The form contains the following fields and options:

- Name: My VPN
- Host name/ IP: (empty field)
- VPN type: IPSec/L2TP, PPTP

At the bottom, there is a navigation bar with a Windows logo, a "Cancel" button, and a "Next" button.

“Make New Connection” page

- 3) Complete the VPN settings. Consult your network administrator for the protocol employed on the VPN and other requested credentials.
- 4) Follow onscreen instructions to proceed.

Once a VPN connection is set up, a link **Edit my VPN servers** shows up under **My Work Network** label.

Proceed to connect to your VPN as described in [Connect To VPN](#).

5.4.2. CONNECT TO VPN

After a VPN connection is set up as described in [VPN Connection Setup](#), a link **Edit my VPN servers** shows up under **My Work Network**. Move on to connect to the prospective VPN.

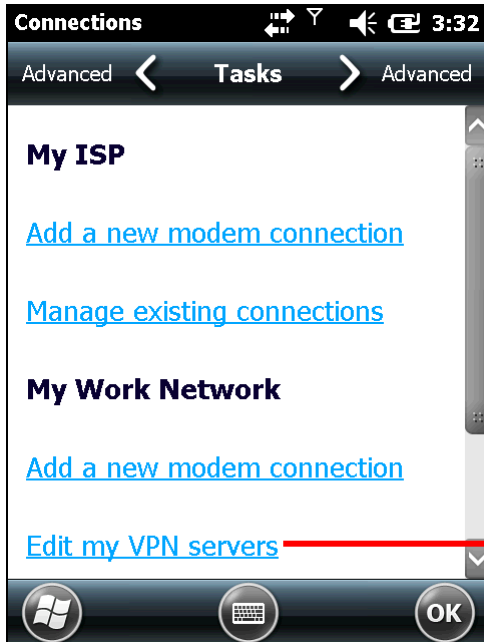

A link **Edit my VPN servers** shows up.

To connect via VPN:

- 1) Tap **Edit my VPN servers** link.

My Work Network opens showing VPN tabbed page.

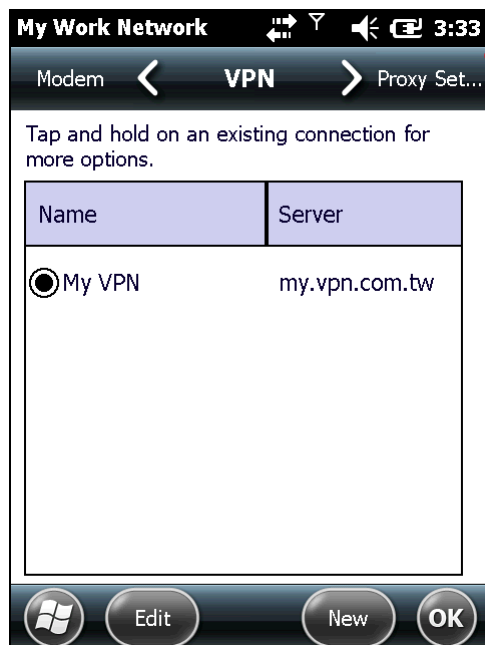

My Work Network's VPN tabbed page

Tap and hold to pop up context menu.

- 2) Tap and hold the VPN to connect.
Context menu shows up.
- 3) Tap **Connect**.

A dialog briefly displays noticing the attempt to connect. VPN is connected shortly. Once connected, the mobile computer makes a sound as per settings in Sounds & Notifications.

5.4.3. EDIT VPN

To edit a VPN:

- 1) On Start screen, tap **Settings** | **Connections** | **Connections** (Manager)  .
Connections (Manager) opens showing Tasks tabbed page.
- 2) Tap **Edit my VPN servers** link.
My Work Network's VPN tabbed page opens.
- 3) Select the VPN to edit.
- 4) Tap the "Edit" command on the softkey bar.
- 5) Follow onscreen instructions to follow through editing.

5.4.4. DELETE VPN

To delete a VPN:

- 1) On Start screen, tap **Settings** | **Connections** | **Connections** (Manager)  .
Connections (Manager)'s Tasks tabbed page opens.
- 2) Tap **Edit my VPN servers** link.
My Work Network's VPN tabbed page opens.
- 3) Tap and hold the VPN to edit.
Context menu shows up.
- 4) Tap **Delete**.
The VPN is deleted.

5.5. INSTALL SECURE CERTIFICATES

To connect to a VPN or Wi-Fi network that deploys secure certificates, the mobile computer must possess these certificates. Where the mobile computer stores these secure certificates is called a “certificate store”.

Windows Embedded Handheld 6.5 has three “certificate stores” – the Personal, Intermediate and Root certificate stores. A certificate store usually has numerous certificates, possibly issued from a number of different certification authorities. To view the certificates stored on the mobile computer, see [View Secure Certificates](#).

5.5.1. SUPPORTED CERTIFICATE FORMATS

Windows Embedded Handheld 6.5 supports installing the following certificate formats:

- ▶ .PFX/.P12 – Public-Key Cryptography Standards #12 (PKCS #12): This file format includes personal certificates with private keys. They install into the intermediate and root certificate stores.
- ▶ CER – Base64-encoded or DER-encoded X.509 certificates that install into the intermediate and root certificate stores.
- ▶ P7B - Public-Key Cryptography Standards #7 (PKCS #7) format files that install multiple certificates to any certificate store on the device.

Certificates with their features:

File Type	Private Key Support	Installs a certificate chain	Installs only one certificate	Installs multiple certificates (can include chains)
.PFX/.P12	Yes	Optional	Optional	Yes
.CER	No	No	Yes	No
.P7B	No	Optional	Optional	Optional

Note: If you are referred to download a certificate from a website, you will be asked to set a password for the credential storage when you download it.

5.5.2. VIEW SECURE CERTIFICATES

Certificates  is the OS’ featured tool to view to the “certificate stores” on the mobile computer.

To view the secure certificates:

On Start screen, tap **Settings** | **System** | **Certificates** .

Certificates open showing Personal certificate store.

5.5.3. INSTALL SECURE CERTIFICATES

It is recommended that you install a certificate issued by a trusted authority. To install a secure certificate:

- 1) Copy the certificate file to the mobile computer first.
- 2) Browse to the file using File Explorer.
- 3) Tap the certificate file to install.

Certificate installer starts to install the file.

- 4) Follow the onscreen instructions to proceed.

Once the installation completes, it can be viewed in Certificates .

5.6. LOCATION DISCOVERY

Adorned with a GPS module, the mobile computer is capable of finding your location on earth. GPS relies on the satellites covering the sky around the world to pinpoint your whereabouts.

A location-aware application is necessary, such as CipherLab's GPS Viewer for NMEA-based location discovery. There are other applications downloadable from Internet. Download ".cab"-suffixed programs that confirm the compatibility with Windows Embedded Handheld 6.5. Note always download programs from trusted sources.

As GPS is a big power consumer, close GPS application when you are not using it.

5.6.1. LAUNCH GPS

The OS doesn't feature any facility to turn on/off GPS module but a GPS intermediate driver (hereinafter "GPSID"), a software layer between GPS hardware and GPS software to stream GPS data from hardware to software without parsing NMEA syntax and in the meanwhile enable multiple applications to simultaneously access GPS data.

Hence the approach to turn on GPS module is to launch a GPS software or a location-aware application on the mobile computer because the software COM port for GPS is turned on then. In case of any difficulty launching GPS, open **Start screen | Settings | System | External GPS | Access** tabbed page to check if **Manage GPS automatically** is selected.

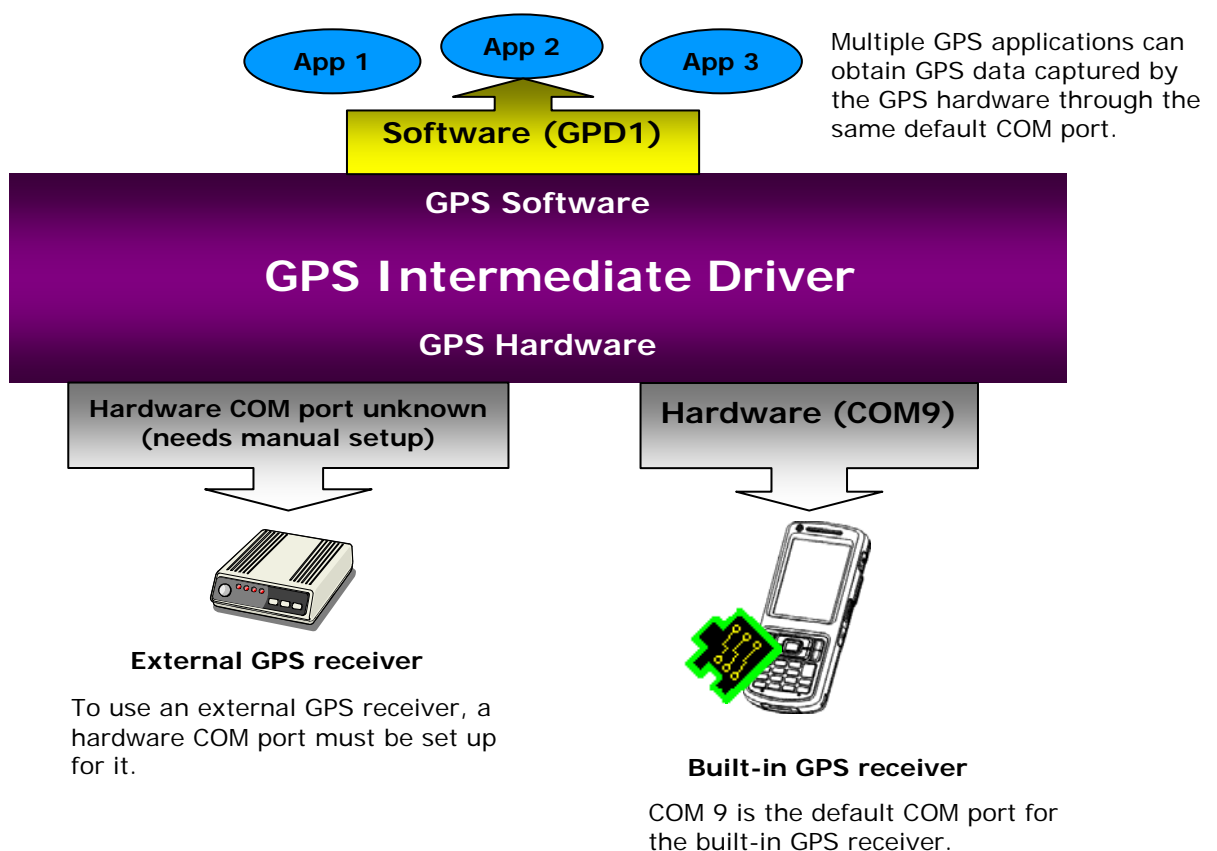

5.6.2. USE GPS

To discover locations by GPS:

- 1) Launch GPS as described in [Launch GPS](#).
- 2) Launch a GPS software or location-aware application (for instance, CipherLab provided GPS Viewer).

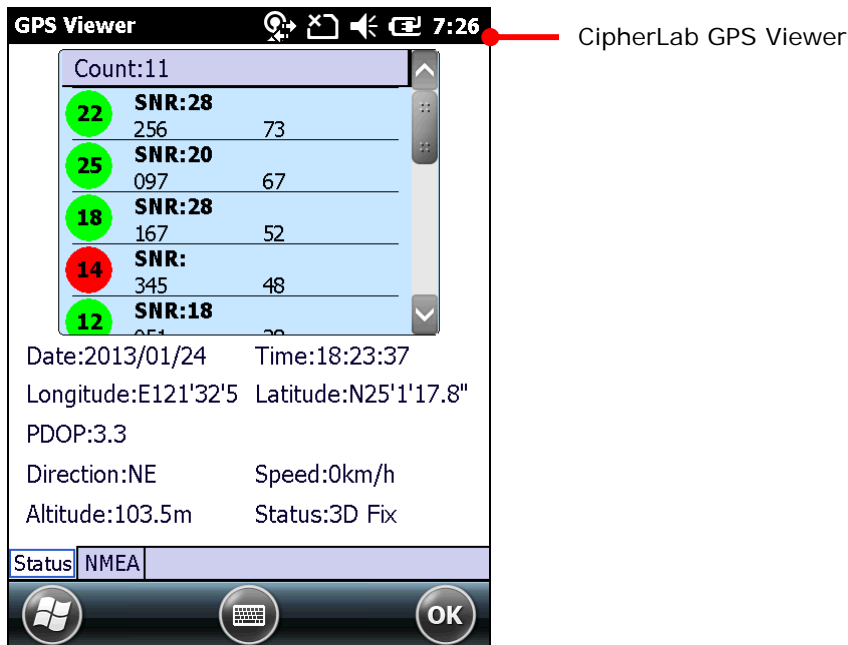

5.6.3. USE EXTERNAL GPS RECEIVER WITH BLUETOOTH

To use an external GPS receiver via Bluetooth connection involves two-phase setup. The first phase is to set up a Bluetooth connection between your mobile computer and the external GPS receiver. The second phase is to set a hardware COM port for the external GPS receiver, as denoted in [Launch GPS](#). Follow the steps below to complete the two-phase setup.

- 1) Power on the external GPS receiver.
- 2) Power on Bluetooth and make it discoverable as described in [Turn On/Off Bluetooth](#) and [Expose Mobile Computer](#).
- 3) Open Bluetooth settings by tapping **Start screen | Settings | Bluetooth** .
- 4) Tap **Add new device...** on the **Devices** tabbed page.

The application will search for and list the discoverable Bluetooth devices within wireless coverage.



Devices tabbed page under Bluetooth

Tap **Add new device...** to search for discoverable Bluetooth devices within wireless coverage

- 5) Select the GPS receiver and tap **Next** on the softkey bar. The mobile computer then attempts to pair with the selected Bluetooth device.

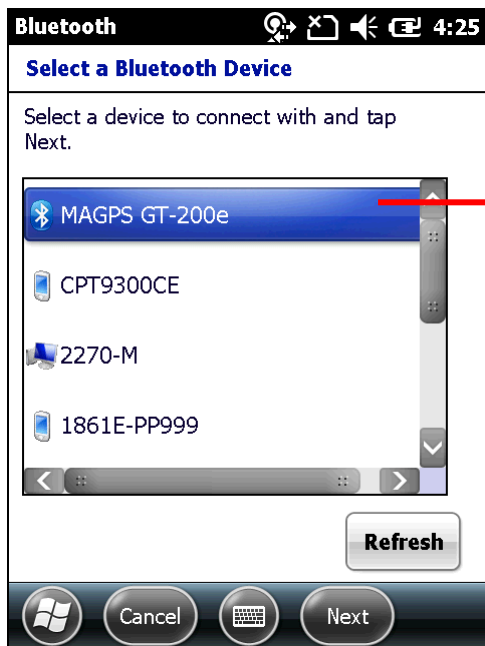

Tap the Bluetooth device you would like to pair with

Your Bluetooth device may request a passcode to create a secure connection. Check the documentation provided by the device manufacturer for more details on the passcode.

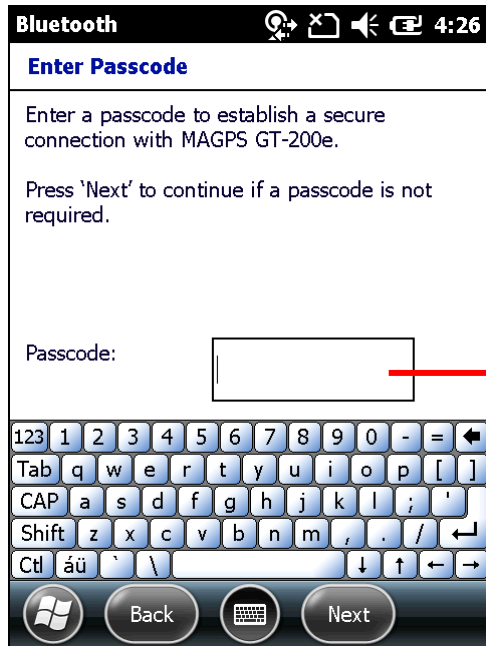

Enter the passcode to complete Bluetooth pairing

Once two devices are connected, you are prompted shortly with a dialog.



The mobile computer is paired with the Bluetooth device

- 6) **Devices** tabbed page opens once more with your GPS receiver added in the paired device list. If the device is paired and connected, it is listed under **Connected** label. If it is paired but unconnected, it is listed under **Disconnected** label. Connection status depends on the Bluetooth feature(s) enabled for the device at the moment.



A paired but currently disconnected device is listed under **Disconnected** label

- 7) Tap your GPS receiver to open **Partnership Settings**. Services available for that device will be listed on this page.

Select **Serial Port** and tap **Save** on the softkey bar. A Bluetooth SPP connection will be established between the mobile computer and the GPS receiver.

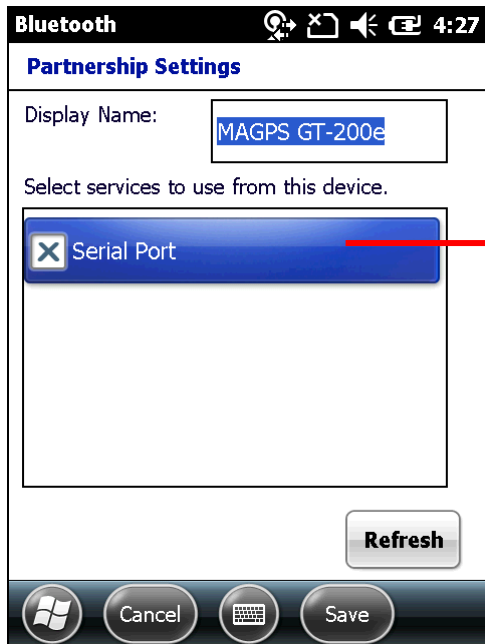

Select Serial Port to establish an SPP connection

- 8) Devices tabbed page opens once more.

- 9) Tap **COM Ports** tab to open **COM Ports** tabbed page.
Tap **New Outgoing Port**, then tap **OK** on the softkey bar.

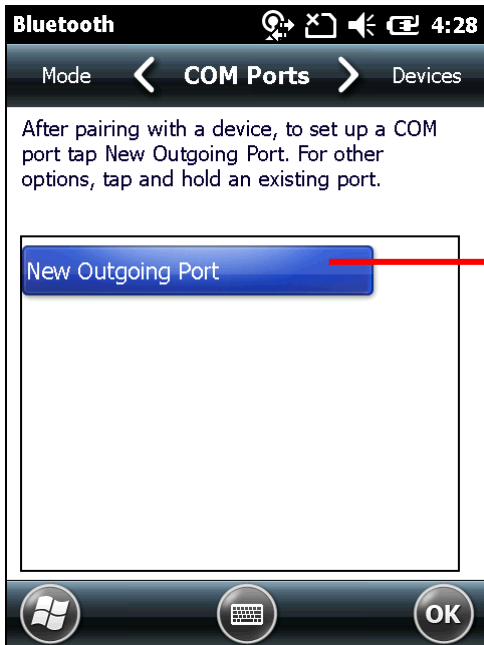

Tap to add an outgoing port for the paired Bluetooth device.

- 10) **Add a Device** page opens.
Select the GPS receiver and tap **Next** on the softkey bar.

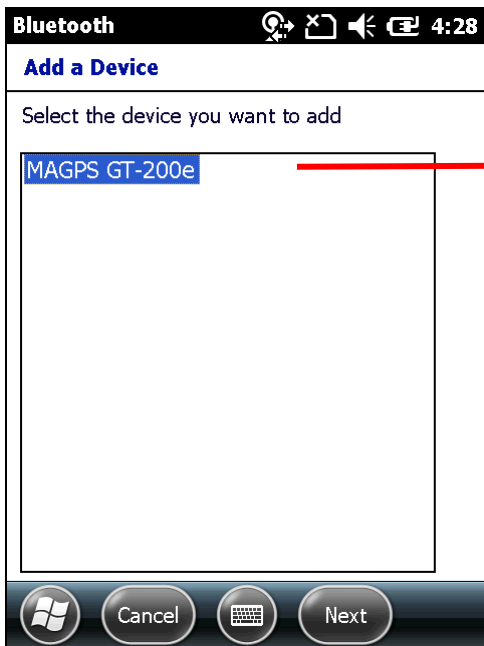

Select the Bluetooth device

- Bluetooth page opens showing a drop-down list for port selection and a checkbox to set secure connection.

Select a port number. You can check the available ports on your mobile computer by tapping **Start screen** | **Settings** | **System** | **COM Port Mapping**. See [COM Port Mapping](#) for details.

Remember the port that you choose.

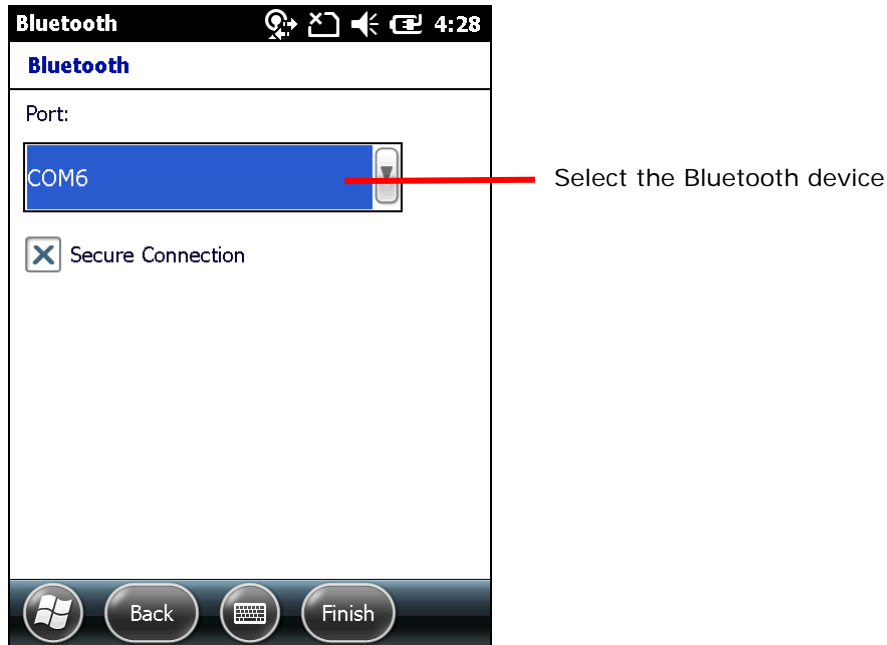

- Tap **Finish** on the softkey bar to re-open **COM Ports** tabbed page. Your GPS receiver and its designated COM port are listed. Tap and hold the GPS receiver to edit the COM port setting.

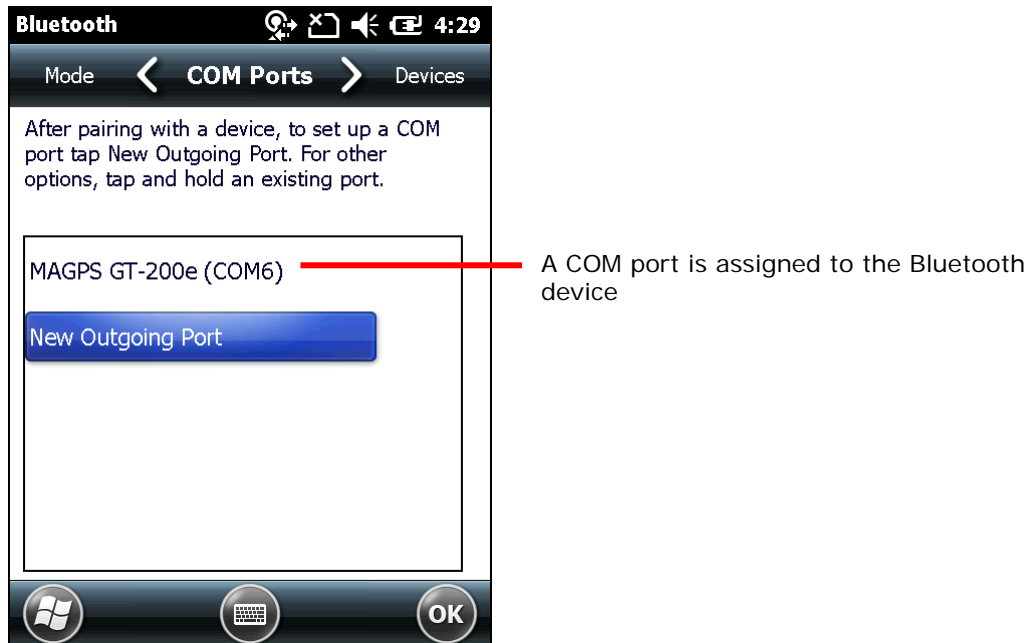

- 13) On Start screen, tap **Settings** | **System** | **External GPS** .

GPS Settings opens to show **Programs** tabbed page.

This page shows the default COM port through which GPS data obtained by GPS hardware is streamed to location discovery applications on the mobile computer. Do not change the settings on this page.

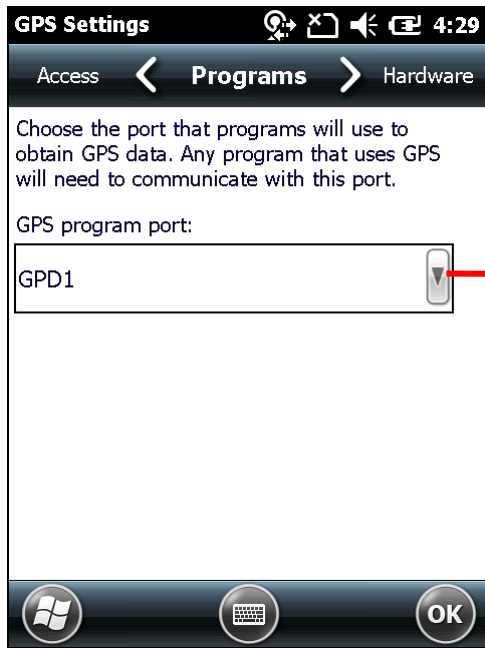

The default COM port the mobile computer uses to stream GPS data to applications

- 14) Tap **Hardware** tab.

Hardware tabbed page opens showing GPS hardware port. The default GPS hardware port on the mobile computer is COM 9. Change this port to the port number you selected in step 10. The mobile computer will use this port to capture GPS data using the external GPS receiver.

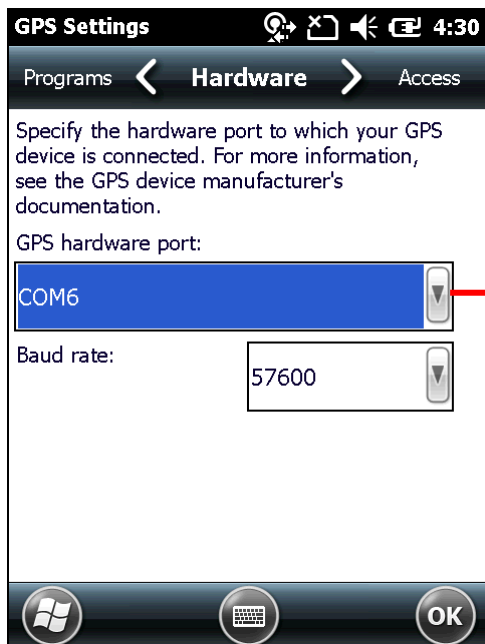

Change GPS hardware port to the port added for the external GPS receiver

15) Tap **Access** tab.

Make sure Manage GPS automatically is selected. Tap **OK** to confirm settings.

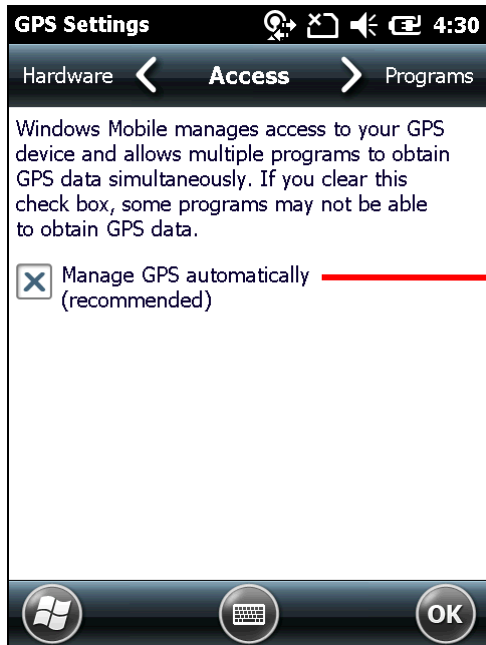

Manage GPS automatically should be selected

16) Run your GPS software or location aware application.

GPS data is streamed to the software to assist location finding.

PHONE

With a SIM card inserted, the mobile computer is capable of data transmission through WWAN.

This chapter depicts SIM card installation and status icons associated with phone status. For the phone's data usage, see [Access Cellular WAN](#).

Note: Phone calling and receiving functions are reserved on CP60. Related settings such as phone volume, phone ring tone, voice mail and so on are reserved as well.

6. IN THIS CHAPTER

6.1 About Phone	180
6.2 SIM Card	180
6.3 Status Icons.....	181

6.1. ABOUT PHONE

The mobile computer supports the following type of cellular technology:

- ▶ GSM
- ▶ UMTS

6.2. SIM CARD

To use the mobile computer's phone, first obtain a SIM card from your mobile carrier. Activate the SIM card and assemble it to the mobile computer. The phone is enabled by default and connects to your wireless network when the mobile computer powers on.

The mobile computer may ask you for a PIN to unlock the SIM card when it powers on. Contact your mobile carrier for their default PIN.

6.2.1. INSTALL SIM CARD

To assemble a SIM card, follow the steps below:

- 1) Power off the mobile computer. Unhook the hand strap and remove the battery door and main battery.
- 2) Using a screwdriver, remove the back cover located at the bottom of the battery chamber.
- 3) Locate the SIM card socket inside the battery chamber. (See also [Inside Battery Chamber](#).)
SIM card socket has a hinged cover.
- 4) Push back the hinged cover to unlock it.
- 5) Swivel up the hinged cover.
- 6) Insert SIM card into the cover slot in the direction indicated . The metal contact pins should face down.
- 7) Put down the hinged cover.
- 8) Lock the hinged cover into place.
- 9) Restore the battery chamber back cover, battery, battery door, and hand strap.

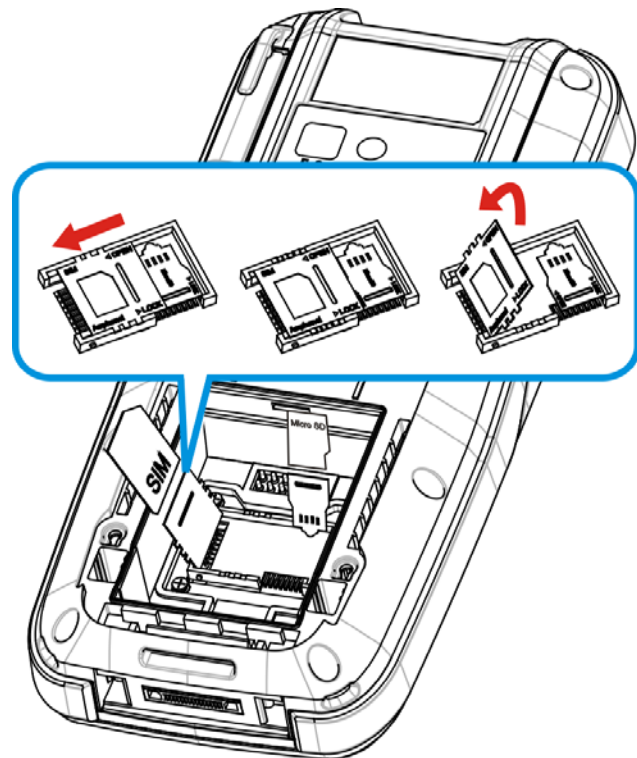







Figure 17: Inserting SIM Card

6.3. STATUS ICONS

Status icons for phone status:

Status Icon	Description
	No SIM card installed
	Phone off
	SIM card locked. PIN code required to turn on phone.
	Phone on with signal strength. The more bars lit, the stronger the signal.
	Connected to another mobile carrier's network (roaming)

Chapter 7

MORE APPLICATIONS

Aside from the dedicated Reader Configuration which empowers the mobile computer's with a specialty in data capture as mentioned in [Data Capture](#), more manufacturer-developed applications are preinstalled to strengthen user's system management and make the mobile computer more eligible.

These applications include:

Applications	Description
Button Assignment	Assigns new functions to some physical keys.
GPS Viewer	Discovers locations.
Signature Utility	Captures, views, edits signatures.
Push to Talk	Allows real-time audio message communication with group members.

7. IN THIS CHAPTER

7.1 Button Assignment.....	184
7.2 GPS Viewer.....	195
7.3 Signature Utility.....	198
7.4 Push to Talk.....	202

7.1. BUTTON ASSIGNMENT

Button Assignment can re-define the functions of physical keys so that they trigger different actions. Settings made to one or more keys can be saved as a profile, allowing users to switch conveniently in between different sets of settings. Key functions under Function Mode (which can be entered by pressing the [Function Key](#)) can also be re-defined.

7.1.1. LAUNCH BUTTON ASSIGNMENT

To launch button assignment:

- 1) On Start screen, tap **Settings | System | Button Assignment** 

Button Assignment opens showing **Normal Mode** tabbed page with an additional **Function Mode** tabbed page.

The Normal Mode tabbed page consists of a table listing three columns: **Icon** column displaying the buttons available for reassignment, **Key** column showing the assigned function of each button, and **Enabled** column to enable or disable the indicated buttons in a single tap.

At the bottom of the screen is a taskbar that can be used to open additional settings, save a profile or refresh settings to the stored profile.

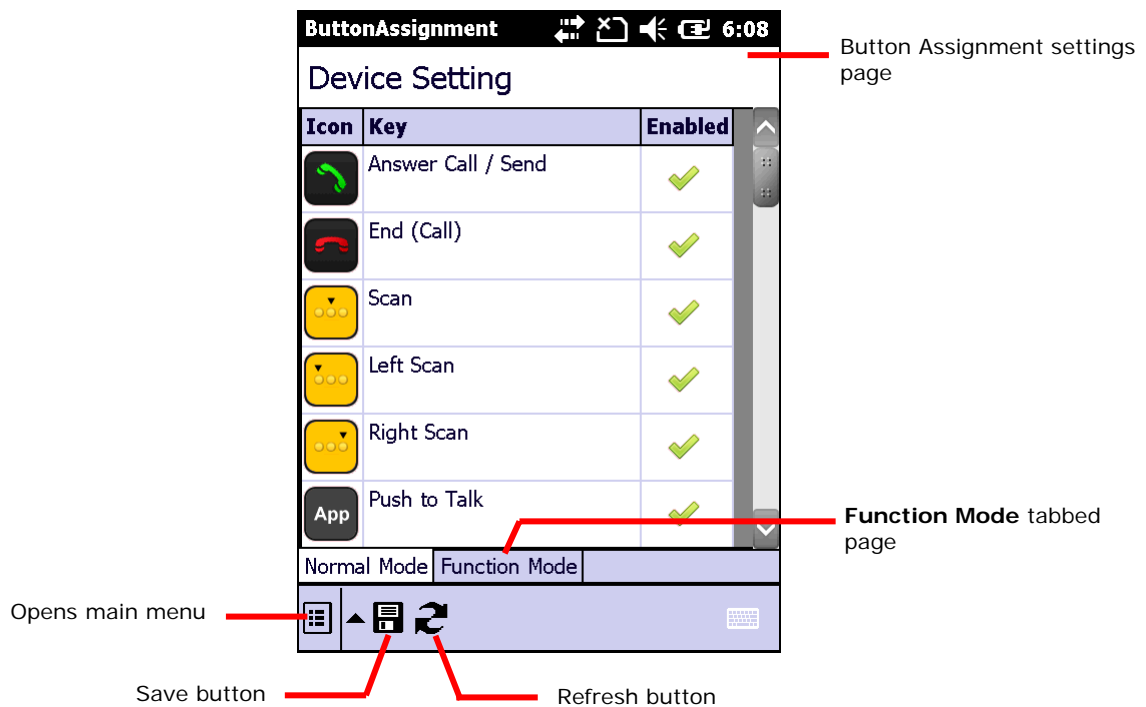

TOOLBAR

Toolbar icon	Description
	Opens Button Assignment main menu which can be used to manage profiles, reset settings to default, obtain version information, or exit the application.
	Saves current settings as a new profile, or saves changes made to the profile currently opened.
	Refreshes the screen to profile settings as stored.
	Opens onscreen keypad.

7.1.2. REDEFINE KEYS



To assign a new function for a re-definable key:

- 1) Launch Button Assignment as described in [Launch Button Assignment](#).
- 2) Scroll to the button you would like to re-define, and tap twice on the icon or text.

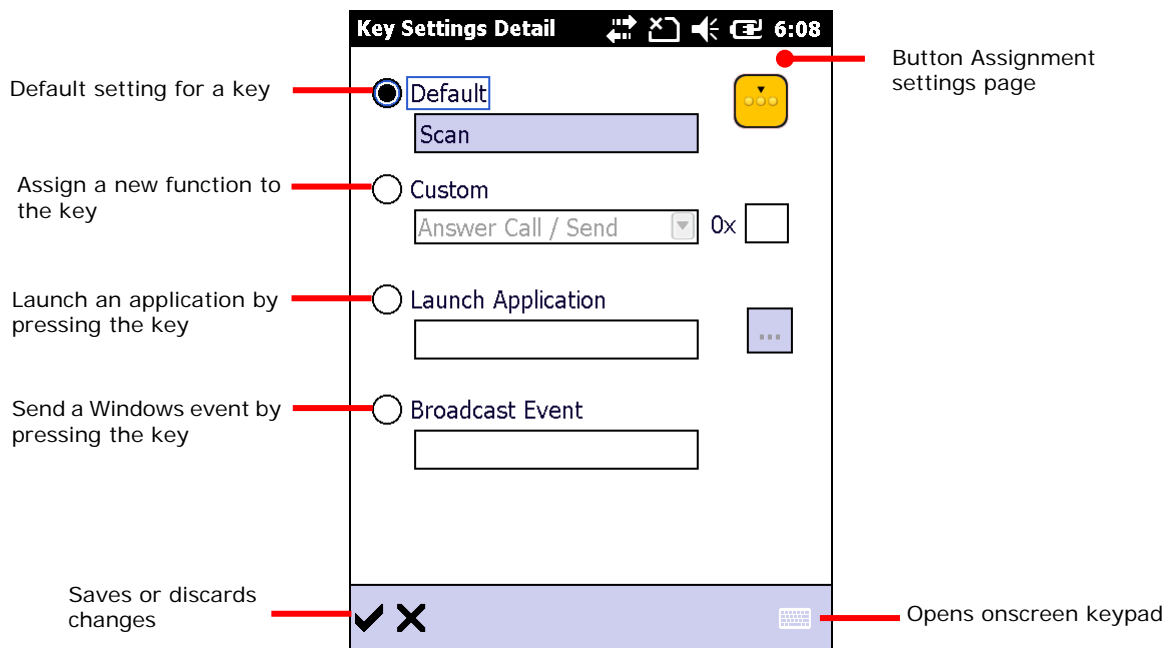
Settings page for that button will open showing four options to set button function.





Item	Value
Default	Sets the key function back to factory default.
Custom	Provides a drop-down list to select the preferred function for the specific key. (Options available differ with the key.) Either select a pre-defined function, or select ""User define" and enter a valid ASCII key code (0x00~0xFF) in the text box.
Launch Application	Opens an application by pressing the specific key. Browse to the .exe file of the desired application.
Broadcast Event	Input a Windows message event which will be triggered each time the button is pressed.

- 3) Re-assign the button as desired, and tap  to save, or  to cancel.
- 4) Open the Button Assignment main menu and tap **Write to device** to apply changes.

DISABLE/ENABLE KEY FUNCTION

The last column in the Device Setting list gives an overview of key status. Users can disable or enable a key by giving a single tap on this column. By disabling keys, keys are "locked" as no actual function will take place when they are pressed.

Enabled items will display as  while disabled items will appear as .

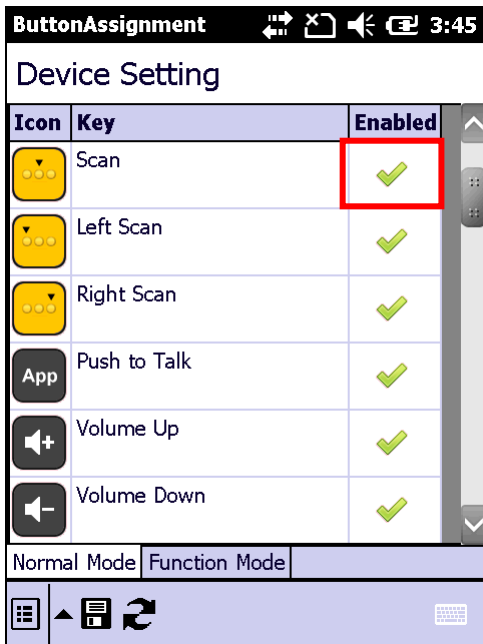

Tap the "Enabled" column to enable or disable the indicated function.

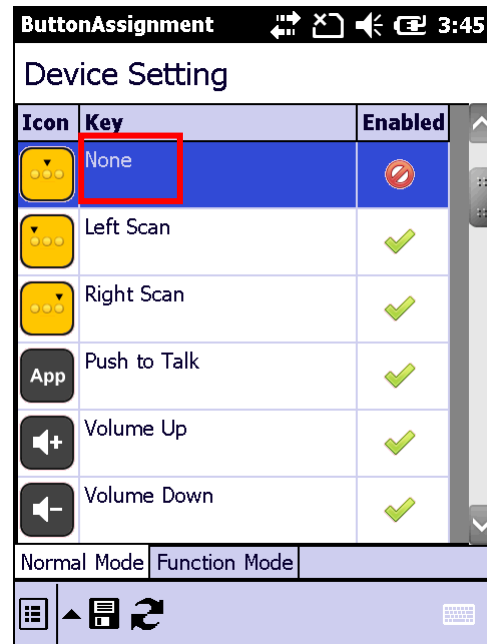





















Once keys are disabled, the icon changes and the function for that key will appear as "None".

Note:

- (1) To access the settings page for a key, its status needs to be set as "Enabled".
- (2) When a key is disabled and then enabled, its function will return to default settings.

7.1.3. MAIN MENU



When the main menu button  is tapped, an option menu opens providing the following functions:

Item	Description												
User Profile	<p>Displays the existing profiles (not including default settings), and a toolbar to manage profiles:     </p> <table border="1"> <thead> <tr> <th>Toolbar icon</th> <th>Description</th> </tr> </thead> <tbody> <tr> <td></td> <td>Applies the selected profile.</td> </tr> <tr> <td></td> <td>Returns to the previous page.</td> </tr> <tr> <td></td> <td>Deletes the selected profile.</td> </tr> <tr> <td></td> <td>Imports a previously exported profile.</td> </tr> <tr> <td></td> <td>Exports the selected profile as an .xml file.</td> </tr> </tbody> </table>	Toolbar icon	Description		Applies the selected profile.		Returns to the previous page.		Deletes the selected profile.		Imports a previously exported profile.		Exports the selected profile as an .xml file.
Toolbar icon	Description												
	Applies the selected profile.												
	Returns to the previous page.												
	Deletes the selected profile.												
	Imports a previously exported profile.												
	Exports the selected profile as an .xml file.												
Read from device	<p>Reads and displays the current settings on the mobile computer. This should be done:</p> <ul style="list-style-type: none"> ▶ Before creating a new profile ▶ To check the current environment on the mobile computer. 												
Write to device	<p>Applies the currently displayed settings to the mobile computer. Button functions on the device will not alter until Write to device is tapped. This should be done:</p> <ul style="list-style-type: none"> ▶ After creating a new profile ▶ After changing an existing profile ▶ After settings are reset to default ▶ After the active profile has been deleted, and the user wishes to replace previous settings on the device. <p>Only by tapping this option will the displayed settings come into action.</p>												
Reset to default	Resets the displayed settings to default. For default settings to take effect on the mobile computer, Write to device must be tapped.												
About	Displays copyright and version information.												
Exit	Exits the application.												

MANAGE PROFILES



CREATE PROFILE

To create a new profile:

- 1) Load factory default settings, or read current settings from device first.
- 2) Modify the settings directly according to your needs, then tap  to open a page where you can enter a name for the new profile.
- 3) Tap  to save, or  to cancel.



EDIT PROFILE

To edit an existing profile:

- 1) Tap the main menu button  and tap **User Profile** in the option menu.
- 2) Select the profile you wish to edit, then tap .
The selected profile opens.
- 3) Modify the profile according to your needs, then tap .
- 4) In the dialog box that appears, tap **Yes** to proceed, or **No** to cancel.

DELETE PROFILE

To delete an existing profile:

- 1) Tap the main menu button  and tap **User Profile** in the option menu.
- 2) Select the profile you wish to delete, then tap .
- 3) In the dialog box that appears, tap **Yes** to proceed, or **No** to cancel.

IMPORT/EXPORT PROFILE

Profile settings can be exported as an independent .xml file, which may be transferred to other devices so they can share identical button assignment settings.

- 1) Open the main menu button  and tap **User Profile** in the option menu.
- 2) Tap  to import a previously exported profile.

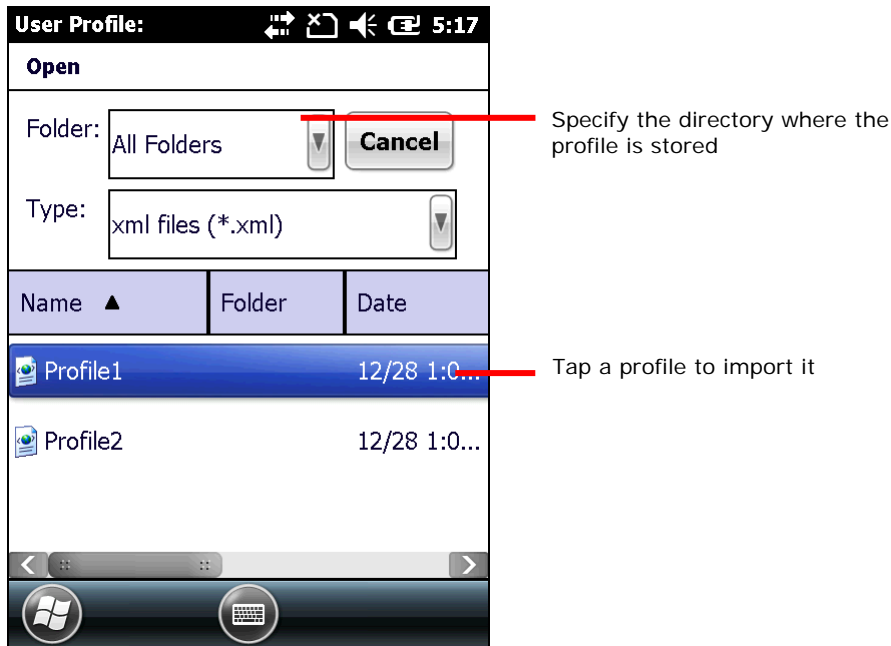

OR

Select the profile you wish to export, then tap  to enter export settings.

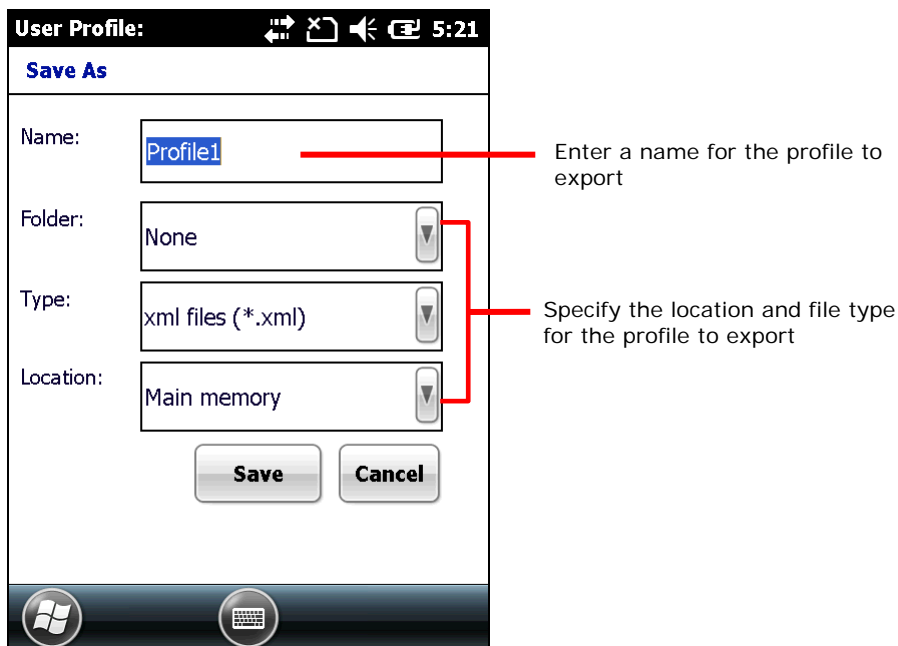

Note: The **All Folders** directory refers to all folders under **My Device\My Documents**. If no subfolder is selected upon export, the exported file will be stored directly under this directory.

3) In the dialog box that appears, tap **Yes** to proceed, or **No** to cancel.

READ/WRITE SETTINGS

Use **Read from device** and **Write to device** to read the current settings on the device, or write the newly changed settings to the device in order for them to take effect. See [Main Menu](#) for when to use these options.

When Button Assignment application is launched, tapping **Read from device** will get the settings currently active on the device, which may be either default settings, a saved profile, or settings previously written to the device. Regardless of where the active settings derive from, they will be presented as “Device Setting” as denoted at the top of the page.

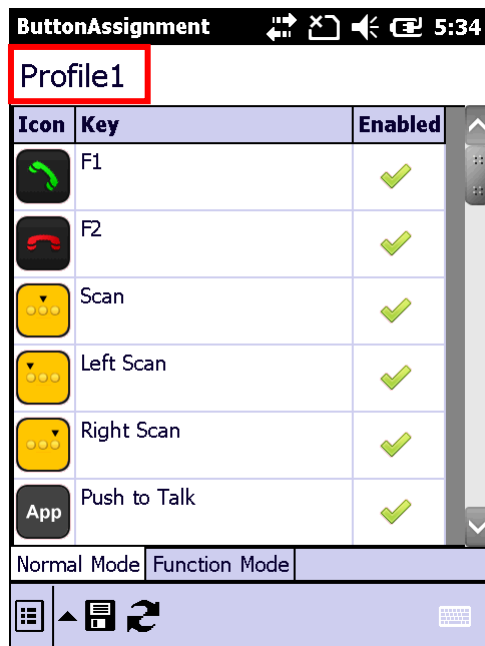

When a new profile is created and saved, the profile name will appear at the top left of the page.

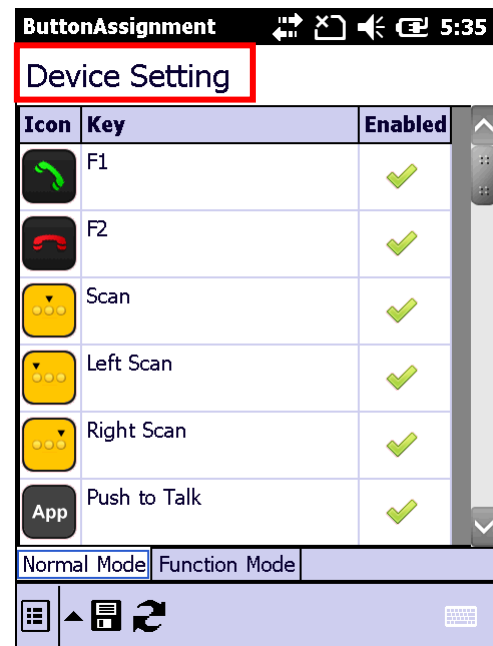

After the profile is written to the device, the profile name will be replaced with “Device Setting” the next time the application is opened, or when **Read from device** is tapped.

RESET TO DEFAULT

















Tapping **Reset to default** in the option menu will display default settings. This can be followed by the steps below.

- ▶ To apply default settings to the mobile computer, tap **Write to device** in the option menu.
- ▶ To create a new profile from default settings, make changes directly and tap the save button

7.1.4. KEYPAD MODES



















Both the numeric and QWERTY keypad provide two different modes, normal mode and function mode. To enable the function mode, simply press the Function key . For behaviors of the Function key, see [Function Key](#).

NUMERIC KEYPAD

Button	Normal mode	Function mode	General options	Special options (Normal mode only)
	Answer Call / Send	Start Screen	Answer Call / Send End (Call)	
	End (Call)	OK	Start Screen OK	
	Scan	N/A	Home End Left	Camera Push to Talk Scan + User define
	Left Scan	N/A	Right Up Down	Camera Push to Talk Scan + User define
	Right Scan	N/A	Page Up Page Down Volume Down Volume Up	Camera Push to Talk Scan + User define
	Application	N/A	Increase Backlight Brightness	Camera Push to Talk
	Volume Up	N/A	Decrease Backlight Brightness	
	Volume Down	N/A	Backspace Enter	
	Left	Home	Esc Tab	
	Right	End	-	
	Up	Page Up	.	
	Down	Page Down	*	
	Backspace	Lock	!	
	Enter	Enter	@	
	Esc	Esc	\$	
	Tab	Tab	%	
			^	
			&	
			(
)	
			1, 2, 3.....9, 0	

	[*] Asterisk key	Increase Backlight Brightness	F1-24 User Define
	[-] Hyphen key	N/A	
	[.] Period key	N/A	
	[#] Number key	Decrease Backlight Brightness	
	Keys 1, 2, 3.....9, 0	--	
	--	F1-12	

QWERTY KEYPAD

Button	Normal mode	Function mode	General options	Special options (Normal mode only)
	Answer Call / Send	Start Screen	Answer Call / Send End (Call)	
	End (Call)	OK	Start Screen OK	
	Scan	N/A	Home End Left	Camera Push to Talk Scan + User define
	Left Scan	N/A	Right Up Down	Camera Push to Talk Scan + User define
	Right Scan	N/A	Page Up Page Down Volume Down Volume Up	Camera Push to Talk Scan + User define
	Application	N/A	Increase Backlight Brightness	Camera Push to Talk
	Volume Up	N/A	Decrease Backlight Brightness	
	Volume Down	N/A	Backspace Enter	
	Left	Home	Esc Tab	
	Right	End	-	
	Up	Page Up	.	
	Down	Page Down	*	
	Backspace	Lock	#	
	Enter	Enter	!	
	Esc	Esc	@	
	Tab	Tab	\$	
	Space	Space	%	
	[&] Ampersand key	--	^	
	[.] Period key	Increase Backlight Brightness	&	
			(
)	
			1, 2, 3.....9, 0	
			F1-24	
			User Define	

	[.] Comma key	Decrease Backlight Brightness
Keys A-Z		--
--	F1-24	

Note: (1) Direct keys (scan key, side trigger keys, volume up/down keys, Application key) on the mobile computer are available for re-assigning only under normal mode.

(2) Several of the direct keys provide special functions under normal mode. These special functions include Camera, Push to Talk , and Scan + User Define.

7.2. GPS VIEWER

The mobile computer includes a GPS module (GPS hardware). This module communicates with the Global Positioning System and discovers your location on earth if it has a piece of GPS software to work with. As previously mentioned in [Launch GPS](#), the GPS module turns on automatically once GPS software launches on the mobile computer.

The preinstalled GPS Viewer is such GPS software. It streams NMEA-based data from the GPS hardware through GPSID.

As per [Launch GPS](#), any GPS software on the mobile computer receives data from GPS hardware through COM port GPD1. Therefore, when GPS viewer is launched, GPD1 opens and readies to stream data on the mobile computer.

7.2.1. LAUNCH GPS VIEWER

To launch GPS Viewer:

- 1) On Start screen, tap **CipherLabUtilities**  .
CipherLabUtilities opens.

- 2) Tap GPS Viewer icon  .

GPS Viewer opens showing **Status** tabbed page. GPS module and turns on.

If there is clear view of the sky, the built-in GPS module auto-searches for available satellites and gets the mobile computer's current location. When finished, time, location, signal-to-noise ratio (SNR) and other positioning information then display onscreen.

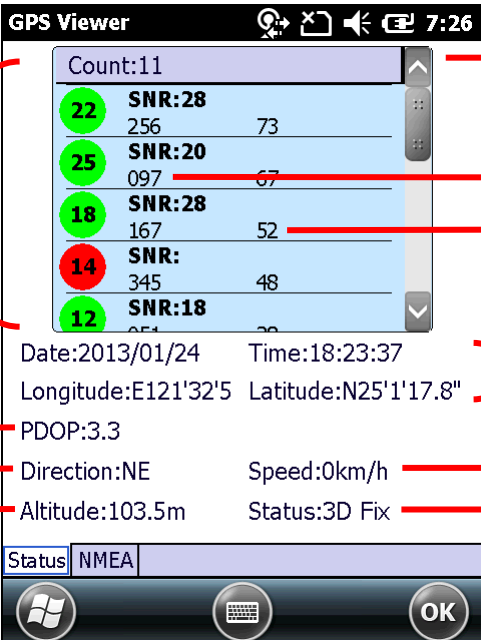

The screenshot shows the GPS Viewer application with the following data and annotations:

- Count:** 11
- Satellite Data:**

22	SNR:28	256	73
25	SNR:20	097	67
18	SNR:28	167	52
14	SNR:	345	48
12	SNR:18		
- Date:** 2013/01/24 **Time:** 18:23:37
- Longitude:** E121'32'5 **Latitude:** N25'1'17.8"
- PDOP:** 3.3
- Direction:** NE **Speed:** 0km/h
- Altitude:** 103.5m **Status:** 3D Fix

Annotations on the right side of the screenshot:

- GPS Viewer opens
- Direction
- Height
- Date, time, longitude, latitude
- In-motion info
- Positioning progress

Annotations on the left side of the screenshot:

- Satellite coverage and SNR
- Satellite signal strength
- In-motion info
- Altitude

- ▶ Red for no signal (< 9 dB)
- ▶ Green for fair signal strength (10 ~ 29 dB)
- ▶ Blue for strong signal strength (30 ~ 50 dB)

Item	Description
Date, Time	Current date and time
Longitude, Latitude, Altitude	Together they deliver the user's location on earth
PDOP	Positional (3D) Dilution of Precision, an indicator about the relationship between the error in user position and the error in satellite position. <ul style="list-style-type: none">▶ Small PDOP value indicates good positioning. Values greater than 7 are considered poor
Direction	Direction when user is in motion
Speed	Relative speed when user is in motion
Status	Delivers positioning progress. <ul style="list-style-type: none">▶ Depending on the number of visible satellites, the status changes from "Tracking" to "2D Fix" to "3D Fix". Under 3D Fix, latitude, longitude and altitude information are all obtained.

Note: (1) To use an external GPS receiver with GPS Viewer, see [Use External GPS Receiver With Bluetooth](#).

(2) To speed up initial startup, download the ephemeris. See [GPS Manager](#) for details.

7.2.2. VIEW NMEA-BASED DATA

The data standard for GPS communication is NMEA. NMEA uses a simple serial protocol to define data syntax. GPS Viewer enables viewing such NMEA data streamed from GPS hardware to software (the application layer). To view NMEA data:

- 1) Launch GPS Viewer as described in [Launch GPS Viewer](#).

GPS Viewer opens showing **Status** tabbed page.

- 2) Tap **NMEA View** tab.

NMEA View tabbed page opens.

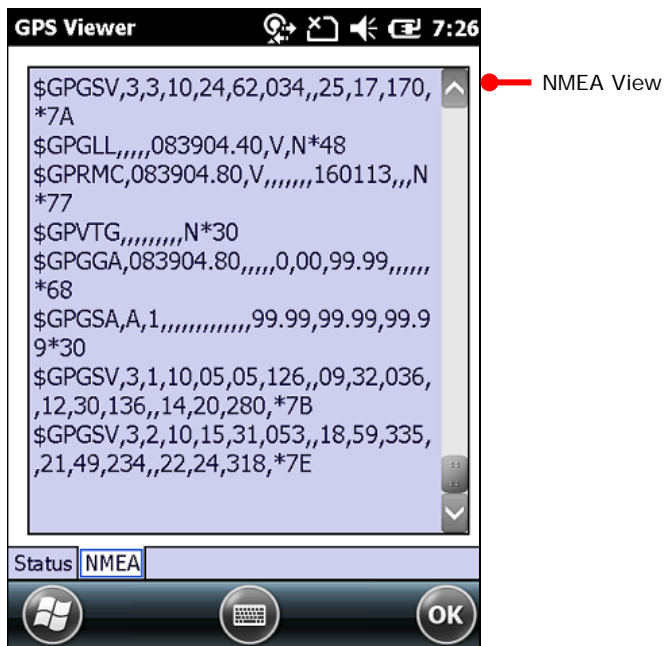

7.3. SIGNATURE UTILITY

Signature utility captures, views and edits signature files.

7.3.1. LAUNCH SIGNATURE UTILITY

To launch Signature utility:





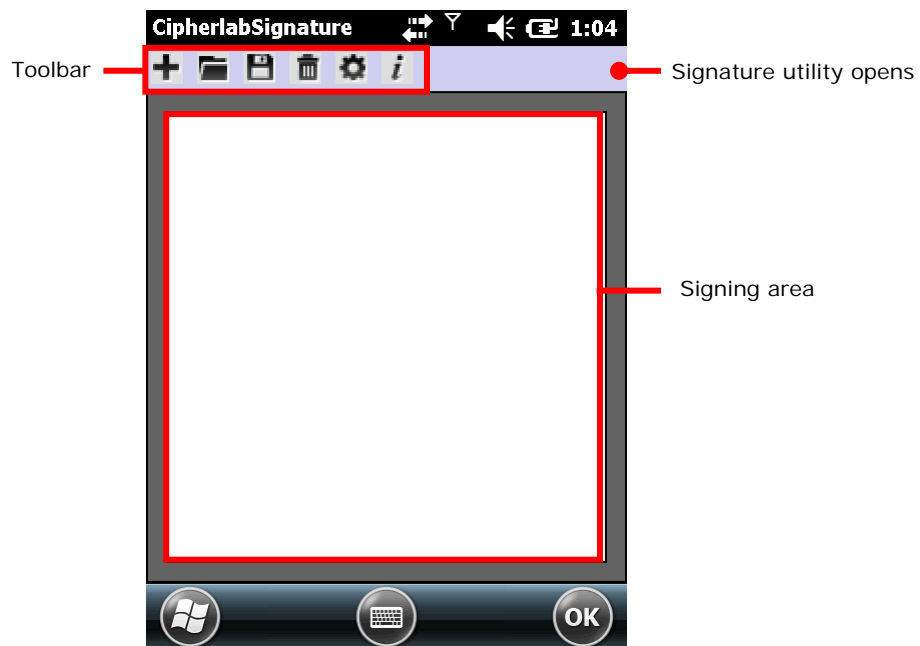

- 1) On Start screen, tap **Signature** .

Signature utility opens showing a toolbar along the top and a signing area within its window.



TOOLBAR & SIGNING AREA

Toolbar features a few icons to launch actions from the utility.

Toolbar icon	Description
	Creates a new file.
	Loads a signature image.
	Saves the affixed signature to an image file (BMP, JPG or Locus format).
	Clears signing area.
	Opens preferences settings.
	Views utility info including developer and software version.

7.3.2. CAPTURE SIGNATURE

To capture a signature:

- 1) Launch Signature utility as described in [Launch Signature Utility](#).
Signature utility launches.
- 2) Use the stylus to sign a name in the signing area.

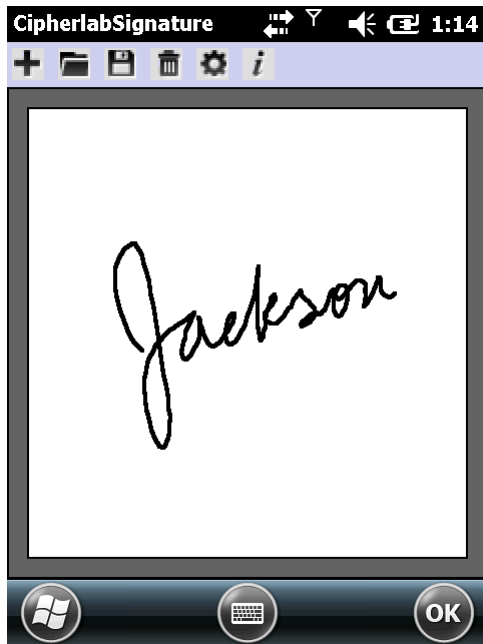

- 3) Tap  icon to save the signature as an image in BMP, JPG or Locus format.

OR

- Tap  icon to discard the signature and sign again.
- 4) Tap the "OK" command on the softkey bar to quit Signature utility.

7.3.3. VIEW OR EDIT EXISTING SIGNATURES

To view the existing signature(s) on the storage of the mobile computer:

- 1) Launch Signature utility as described in [Launch Signature Utility](#).

Signature utility launches.

- 2) Tap  icon on toolbar.

The utility opens a screen allowing users to select the location and file type of the signature to view.

- 3) Browse to the folder where the signature is stored, and select which file type of signature to view.

All signature files meeting the requirements are listed.

- 4) Tap the signature file to view.

The file opens onscreen overlaid by a dialog asking if you want to modify the opened signature file.

- 5) Confirm **Yes** if you want to change the opened signature.

OR

Confirm **No** if you only want to view it.

Note:

- (1) Signature utility loads images of maximum 640 x 480 pixels. If it tries to load an image beyond this limit, an error message will prompt and the image cannot be opened.
 - (2) The **All Folders** directory refers to all folders under **My Device\My Documents**.
-

7.3.4. PREFERENCES

The utility supports preferences settings which change the utility's behaviours when it is used. Users are able to change the size and color of the signing pen stroke, and customize the background color of the signing area.

To access the utility's preferences settings:

- 1) Launch Signature utility as described in [Launch Signature Utility](#).

Signature utility launches.

- 2) Tap  icon on toolbar.

Preferences settings open showing **Pen Width** tabbed page.

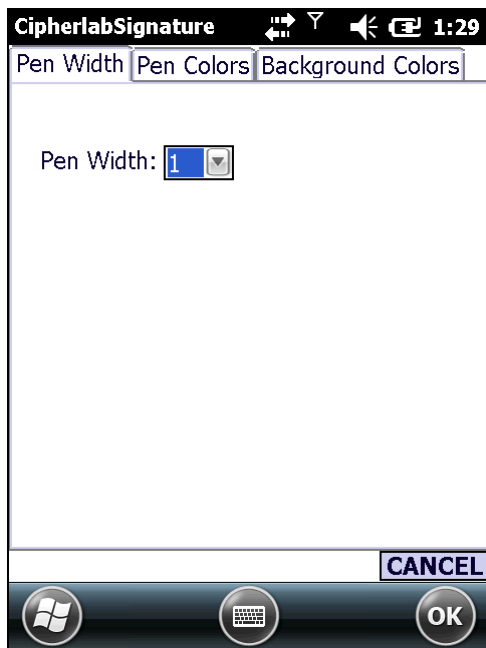

- 3) Select between **Pen Width**, **Pen Colors** and **Background Colors** tabs to customize signing preferences.
- 4) Tap the "OK" command to save changes, or tap **CANCEL** label to quit settings without saving changes.

7.4. PUSH TO TALK

CipherLab Push to Talk is a walkie-talkie service that allows users of an active talk group to communicate with all other members of the group instantaneously with a simple push of a button.

7.4.1. LAUNCH PUSH TO TALK

Once Push to Talk is launched for the first time on the mobile computer, it will be continuously running in the background to enable real-time communication.

To launch Push to Talk for the first time:

- 1) On Start screen, tap **CipherLab | Push to Talk** .

Push to Talk opens showing a push button in the middle and a menu bar at the top.

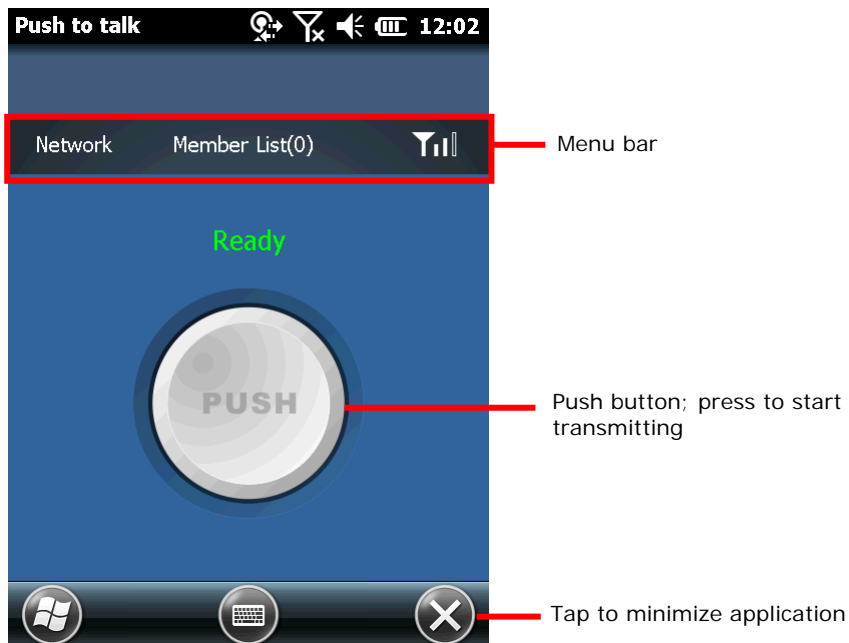

7.4.2. COMMUNICATE WITH GROUP MEMBERS

Push to Talk functions through group communication, meaning that when an audio transmission is initiated on one device, all other devices in that group will receive the audio message. Groups are established by Wi-Fi connection under a specific subnetwork (subnet). All devices that are currently running Push to Talk and are connected within a certain wireless subnet will be automatically incorporated as a group member.

A mobile computer can communicate with group members either by sending out audio content, or by receiving it. When a member in the group initiates an audio content, all other members turn into recipients and will automatically receive the audio content on their mobile computer.

Note: For optimized performance, the Wi-Fi signal strength should be stronger than -60 dB.

SENDING AUDIO CONTENT

To send audio content to other devices:

- 1) Have all devices you would like to communicate with connect to a specific (or several specific) access point(s) as described in [Use Wi-Fi](#). Make sure these access points belong to the same subnet.
- 2) On all of the devices, launch Push to Talk as described in [Launch Push to Talk](#).

Push to Talk opens in voice reception mode.

Push to Talk also provides a shortcut to set Wi-Fi connection. Tap **Network** on the Push to Talk menu bar to open the Summit Client Utility, and proceed to set up or check current Wi-Fi connection as described in [Use Wi-Fi](#).

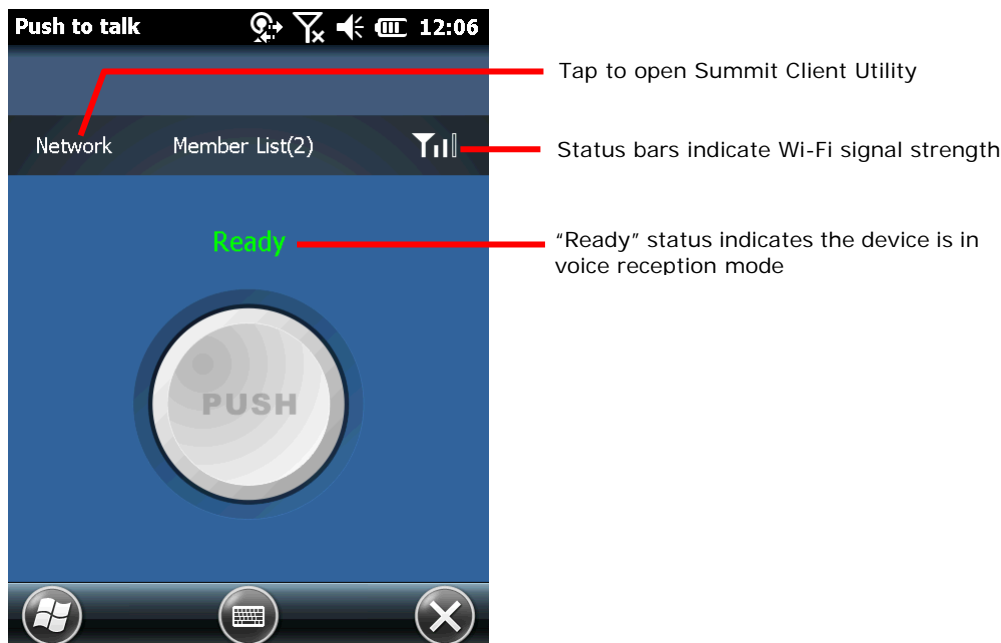

- 3) Tap and hold the **PUSH** button. The button will turn red to indicate the device is ready for transmission. You can start talking into the receiver to transmit your message to all other devices in the group.

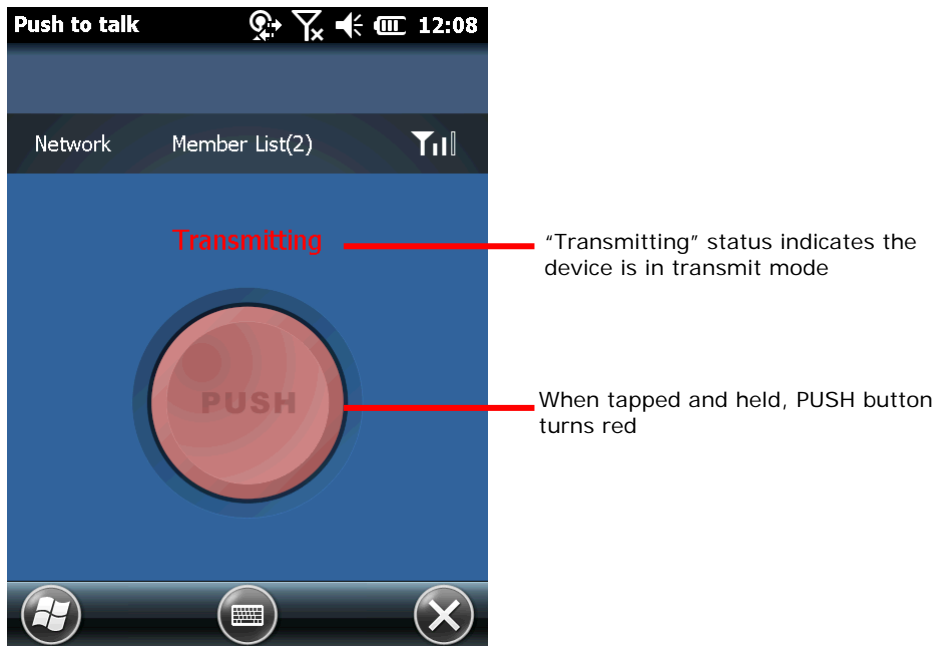

When finished transmitting the audio message, let go of the **PUSH** button. The button will return to gray and the mobile computer will switch back to voice reception mode.

RECEIVING AUDIO CONTENT

To receive audio content from group members:

- 1) Have all devices you would like to communicate with connect to a specific (or several specific) access point(s) as described in [Use Wi-Fi](#). Make sure these access points belong to the same subnet.
- 2) On all of the devices, launch Push to Talk as described in [Launch Push to Talk](#).

Push to Talk opens in voice reception mode.

When another device in the group is sending out audio content, the **PUSH** button will become deactivated, and the device name currently transmitting the audio message will be shown on-screen.

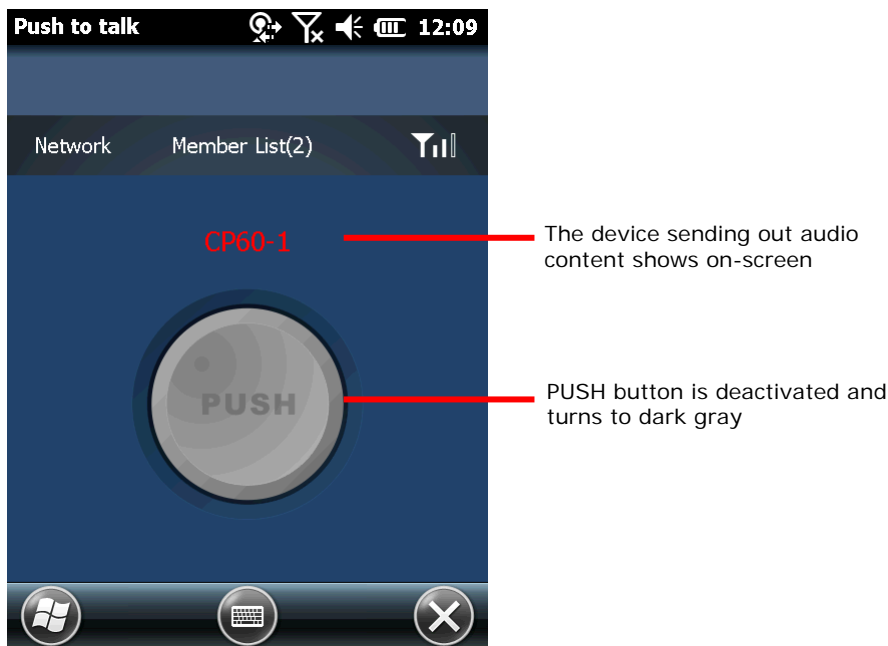

- 3) As long as Push to Talk is running on the system, it is still open to receive audio messages from other devices even if it is not the active application onscreen. If you are working on other tasks or applications, the mobile computer will still receive audio messages once they are transmitted.

Note: The mobile computer will not be able to receive audio content when the system is under suspension, or when Wi-Fi has been disconnected.

ASSIGNING OTHER KEYS AS PUSH BUTTON

By default, communication can be done by tapping and holding the **PUSH** button on-screen. Alternatively you may assign a physical key to function as the **PUSH** button. The keys available for assignment are:

- ▶ Scan key
- ▶ Side triggers (Left and right scan keys)
- ▶ Application key

See [Button Assignment](#) for how to re-assign the above physical keys.

MANAGING MEMBER LIST

The Member List will show all other devices (not including the device under operation) that have connected to the wireless subnet and are currently running the Push to Talk application.

OPEN MEMBER LIST

- 1) Launch Push to Talk as described in [Launch Push to Talk](#).
- 2) Tap **Member List** on the Push to Talk menu bar to view all members in the current group.

The number of devices connected to the group will be shown on the Member List label.

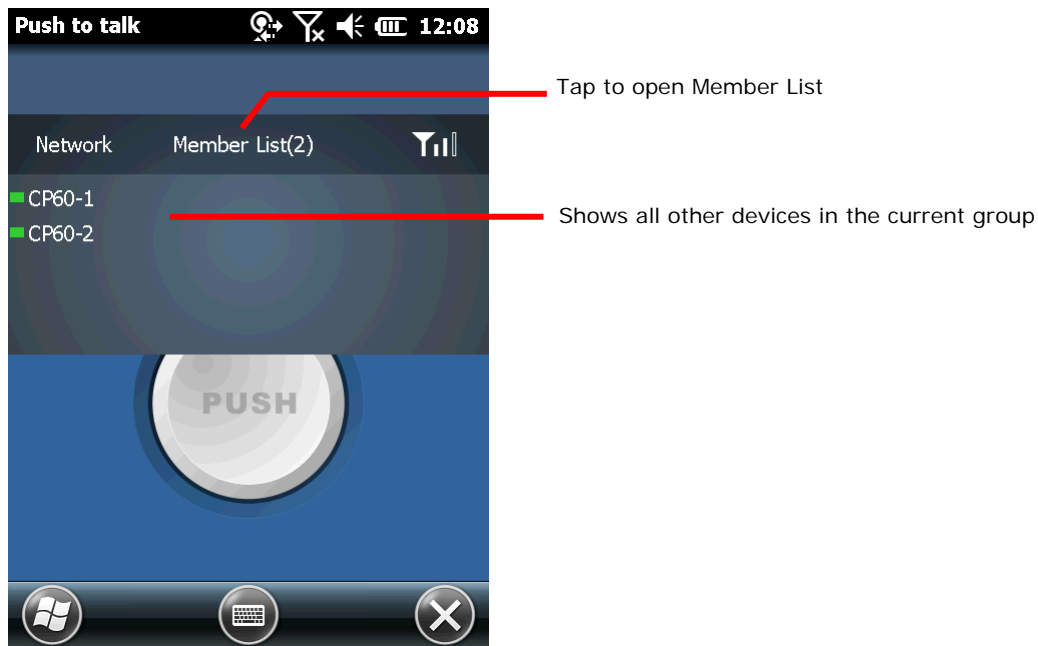

Tap **Member List** again to close the list.

CHECK MEMBER STATUS

In the Member List, a short bar in front of the device name will change its color to indicate the status of that device. Possible colors are:

Status	Mode	Meaning
Green	Voice reception mode	Device is connected to the wireless subnet and is currently running Push to Talk.
Red	Active transmit mode	Device is transmitting audio message to other devices.
Yellow	Passive transmit mode	Device is receiving audio message from another device.
Gray	Disconnected	Device has been disconnected from the group. Make sure device has Wi-Fi access, the system hasn't shut down or entered suspension, and is still running the Push to Talk application.

VOICE RECEPTION MODE

When Push to Talk is opened, devices will be in voice reception mode and are ready to receive audio content. The status bar before the device name appears in green.

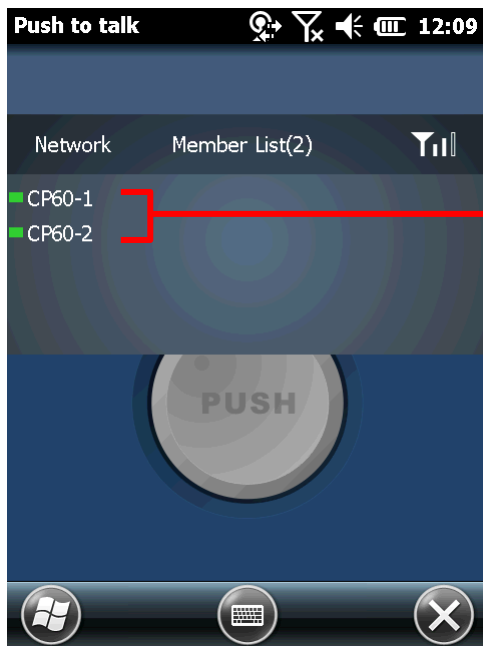

Green indicates a device is in voice reception mode

ACTIVE AND PASSIVE TRANSMIT MODES

When one of the devices in the group is sending out audio content, the status before that device name will change to red. The status for all other devices will change to yellow.

Note that in a certain group, only one device can be sending out audio content at a time. A separate transmit session can only be initiated when all devices have returned to voice reception (green) mode.



Red indicates a device is currently transmitting audio content

Yellow indicates a device is currently receiving audio content

DEVICE DISCONNECTED

When one or more of the devices in the group is disconnected, the status bar before the device name will change to gray. The **Member List** label will be updated to reflect the remaining number of connected devices. When this occurs, check the Wi-Fi connection status on that specific device, make sure the mobile computer is powered on and not under suspension, and the Push to Talk application is currently running.

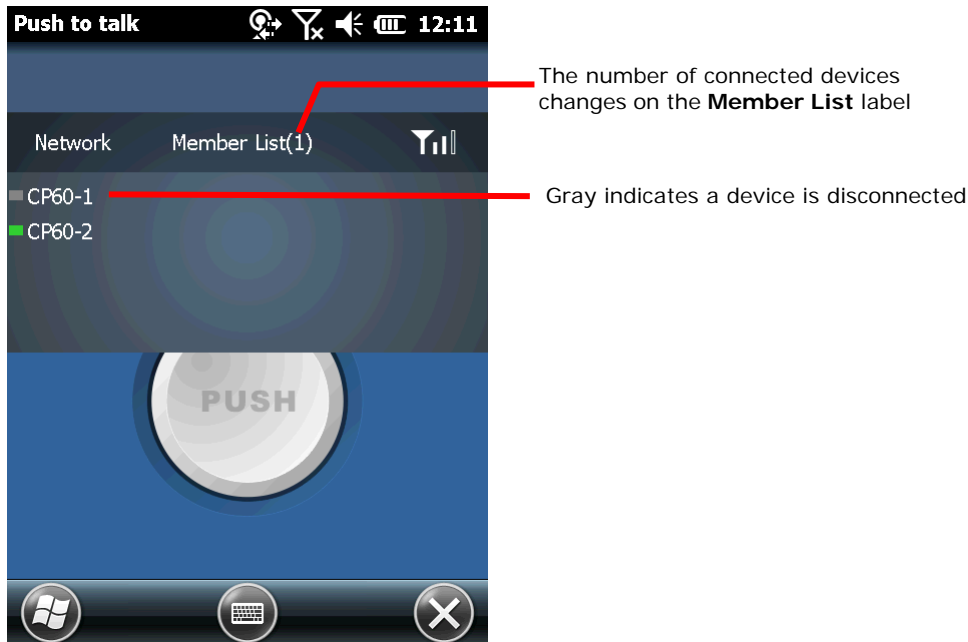

CHANGING DEVICE NAME

In the member list, device names will appear as individually set under **Start Screen | Settings | System | About | Device ID** tabbed page. If you have a number of devices in the same group, modify the device names on some or all of them in order to distinguish between them.

Note: After changing the device name on one or more of the devices, have all the other devices in the group shut down Push to Talk as described in [Close Applications](#) and re-open it again. This will update the device names shown in the member list.

Chapter 8

MANAGE MOBILE COMPUTER

This chapter guides you to the system settings featured by the OS. Access these settings to define how the mobile computer looks, sounds, stores/secures your data, manages the applications, or exchanges data with your networks or other devices.

This chapter also includes a section detailing the mechanism you follow suit to update OS image.

8. IN THIS CHAPTER

8.1 Update OS Image	210
8.2 System Settings	212

8.1. UPDATE OS IMAGE

OS image upgrade helps optimize the mobile computer's performance and functionality. The upgrade relies on CipherLab's **OS Update Tool**, a utility to run on your PC to get the job done. This utility brings the upgrades of OS image and splash (booting logo) to the mobile computer. Contact CipherLab's sales representative in your local area for the utility and update releases.

8.1.1. USB UPDATE

To upgrade the OS image:

- 1) Connect the mobile computer and your PC as mentioned in [Sync Partnership](#).
- 2) Run CipherLab **OS Update Tool** on your PC.

CipherLab **OS Update Tool** opens.

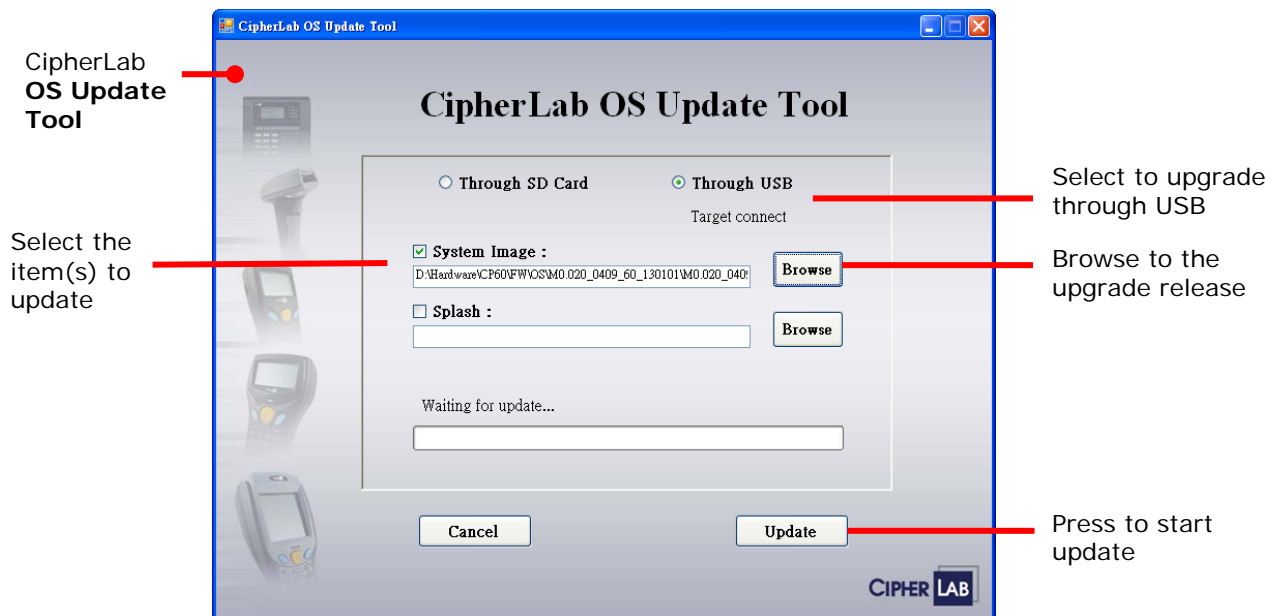

- 3) Select **Through USB**. Click **Browse** and select the OS image to update.
- 4) Press **Update**.

The selected OS image is copied to the mobile computer.

- 5) The mobile computer will restart directly and proceed to install the updated OS.

The following notification will appear onscreen to indicate the system is updating.

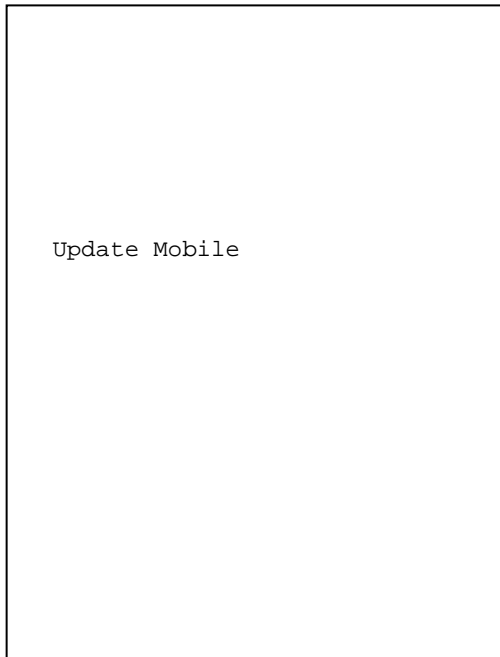

- 6) When the update process is finished, a prompt will appear onscreen asking to cold boot the mobile computer. Cold boot the mobile computer by holding down the power button and pressing the reset button.

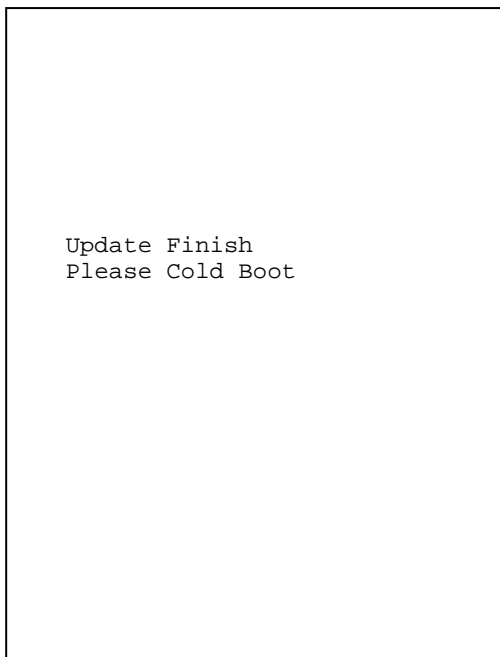

- 7) After the mobile computer powers on, it will enter calibration directly. Follow onscreen instructions to calibrate the touchscreen as described in [Calibration](#).

After calibration, the mobile computer will proceed to auto-installation of system applications. When installation is completed, users can then check the OS version by tapping **Settings | System | System Information | Version** subcategory.

8.2. SYSTEM SETTINGS

This section guides to Windows Embedded Handheld 6.5 system settings. Access these settings to define how the mobile computer looks, sounds, stores/secures data, manages applications, or exchanges data with networks or other devices.

To access system settings:

Open Start screen, tap **Settings** icon . System settings open:



Bluetooth

Configures Bluetooth data connection. See [Use Bluetooth](#).



Clock & Alarms

Sets RTC time, calendar, time zone, and up to three alarms which can serve as reminders.

Note: RTC time can be reserved for approximately 60 days on the mobile computer after the main battery pack has been removed.



Home (Today)

Customizes the background and items displayed on Today screen. See also [Customize Today Screen](#).



Lock

Sets up a screen lock mechanism to limit access to the mobile computer. See also [Set Screen Lock](#).



Connections Folder

Leads to the settings for radios, connection status and others. See also [Connections Folder](#).



Personal

Accesses phone settings and assigns a program to a button. Users can also record information about the owner of the mobile computer.



System

Leads to [System Folder](#), where the hardware and software on the mobile computer can be configured and their info can be viewed.



Sounds & Notifications

Configures the mobile computer’s sound upon tapping onscreen commands or physical buttons, how a notification or system event is received, how an alarm sounds, and related settings.

Note Sounds & Notifications doesn’t turn on/off the audio from music, videos, and other media. This audio broadcast should be silenced in the applications that run them.

Sounds & Notifications features two tabbed pages, **Sounds** and **Notifications**:

Tabbed page	Description
Sounds	Mutes/unmutes the sounds for system events, programs, screen taps, and physical key pressing.
Notofications	Configures the ring type for a number of system events such as established or disconnected connections and so on.

8.2.1. CONNECTIONS FOLDER

This section guides to applications available in **Connections Folder** under System Settings.

Open Start screen, tap **Settings | Connections** .

Connections folder opens:



BEAM

For Windows Mobile and Windows Embedded Handheld, “beam” is typically known as data sharing between handheld devices through infrared or Bluetooth.

Open **Beam** application and select **Receive all incoming beams** to enable Bluetooth-based data exchange with other devices.



DOMAIN ENROLL

Connects to a SCMDM (System Center Mobile Device Manager) server with an enrollment ID and password. SCMDM enables the management of multiple mobile computers.



NETWORK CARDS

Opens Network Cards page that features Network Adapters settings.

- ▶ Modifies network card settings such as static IP connection, setups server connection, and configures where the network cards connect to, Internet or your work network.

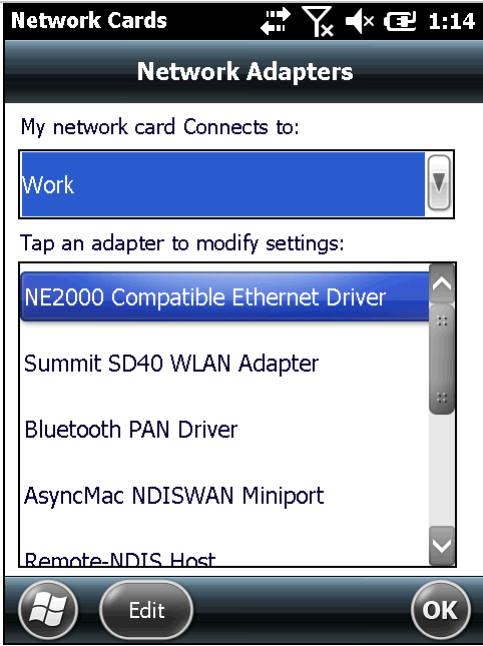

WIRELESS MANAGER

Enables/disables the radios of Wi-Fi, Bluetooth, phone, and mobile data. It also limits mobile data to 2G only. See [Use Only 2G Networks](#).

Wireless Manager opens showing a few entries:

- ▶ **All:** Turns on/off all the radios on the mobile computer except Wi-Fi and GPS. (GPS is turned off by losing GPS-dependent applications).
- ▶ **Wi-Fi:** Checks Wi-Fi power and connection status. (To switch on/off Wi-Fi power, see [Use Wi-Fi](#)).
- ▶ **Bluetooth:** Turns on/off Bluetooth.
- ▶ **Phone:** Turns on/off phone and mobile data.

Tap the “Menu” command on the softkey bar to disconnect cellular data or access Wi-Fi Settings, Bluetooth Settings, and Phone Settings.

Setting	Description
Disconnect Cellular Data	Turns off mobile data without turning off phone.
Wi-Fi Settings	Opens Network Cards .
Bluetooth Settings	<p>Bluetooth settings feature three tabs – Devices, Mode and COM Ports.</p> <p>Devices tabbed page:</p> <ul style="list-style-type: none"> - Searches for devices and selects devices to connect. - Edits, disconnects from, and unpairs from connected devices. - Edits, reconnects to, and unpairs from disconnected devices. <p>Mode tabbed page:</p> <ul style="list-style-type: none"> - Turns on/off Bluetooth. - Hides/reveals the mobile computer from/to other

	<p>Bluetooth devices.</p> <p>COM Ports tabbed page:</p> <ul style="list-style-type: none"> - Sets up COM ports for a paired device. - Edits an existing port.
Phone Settings	<p>Phone settings are only available when a SIM card is assembled and the phone is turned on.</p> <p>Phone settings features four tabs – Sounds, Security, Services, Network.</p> <p>Sounds tabbed page (Reserved)</p> <ul style="list-style-type: none"> - Configures phone ring type. - Configures phone ring tone. - Configures keypad tones. <p>Security tabbed page</p> <ul style="list-style-type: none"> - Enables/disables PIN code(s) for the inserted SIM card. - Edits the existing PIN code(s) of the inserted SIM card. <p>Services tabbed page (Reserved)</p> <ul style="list-style-type: none"> - Call Barring: Blocks certain types of incoming and outgoing calls. - Caller ID: Sets if your phone number is displayed to whom you call. - Call Forwarding: Configures how to forward your calls when you're on a phone already, you didn't answer and so on. - Call Waiting: Configures whether to be noticed of any incoming call during a call. - Voice Mail & Text Messages: Sets the phone number that accesses voicemails. As long as a number is set here, you are able to quickly access voicemail box by Phone application's Speed Dial. - Fixed Dialing: When your mobile carrier supports fixed dialing, phone can be set to place calls only to the fixed dialing numbers (FDN) saved on SIM card. Enable/disable FDN by selecting/deselecting Enable fixed dialing. <p>Network tabbed page</p> <ul style="list-style-type: none"> - Current network: Delivers the mobile network currently connected to. - Network selection: Configures how to select network, automatic or manual. - Find Network: Registers other mobile networks. - Set Networks: Selects preferred networks and orders them to your preference.



CONNECTIONS (MANAGER)

Sets mobile data connection with two tabbed pages – **Tasks** and **Advanced**.

Page	Description						
Task tabbed page	<p>Sets where mobile data connects to, to Internet (My ISP), or to an internal network (intranet) or a VPN (My Work Netowrk).</p> <table border="1" data-bbox="507 371 1310 1697"> <thead> <tr> <th data-bbox="507 371 644 434">Setting</th> <th data-bbox="644 371 1310 434">Description</th> </tr> </thead> <tbody> <tr> <td data-bbox="507 434 644 857">My ISP</td> <td data-bbox="644 434 1310 857"> <p>Sets up mobile data connection to the Internet. It provides two links – Add a new modem connection and Manage existing connection. The latter is only available after a connection is set up. See also Edit & Add Access Points.</p> <ul style="list-style-type: none"> ▶ Add a new modem connection <p>Creates a mobile data connection to Internet. Request your mobile carriers for the information needed. See also Cellular Data Setup.</p> ▶ Manage existing connections <p>Edits existing mobile data connection to Internet.</p> </td> </tr> <tr> <td data-bbox="507 857 644 1697">My Work Network</td> <td data-bbox="644 857 1310 1697"> <p>Creates mobile data connection to an internal network (intranet) or a VPN. For enterprise network to access Internet, proxy server setting which is usually required is supported.</p> <ul style="list-style-type: none"> ▶ Add a new modem connection <p>Creates a mobile data connection to internal network (intranet) or VPN. Request network administrator for the information needed.</p> ▶ Add a new VPN server connection <p>Sets up a VPN connection. Request your VPN administrator for the details required.</p> <p>After a VPN is set up, Add a new VPN server connection changes to Edit my VPN servers.</p> ▶ Set up my proxy server <p>Sets up the proxy server by which an enterprise network connects to Internet.</p> <p>After a proxy server is set up, Set up my proxy server changes to Edit my proxy server.</p> ▶ Manage existing connections <p>Edits existing mobile data connection to internal network (intranet) or VPN. Request your network administrator for the related information.</p> </td> </tr> </tbody> </table>	Setting	Description	My ISP	<p>Sets up mobile data connection to the Internet. It provides two links – Add a new modem connection and Manage existing connection. The latter is only available after a connection is set up. See also Edit & Add Access Points.</p> <ul style="list-style-type: none"> ▶ Add a new modem connection <p>Creates a mobile data connection to Internet. Request your mobile carriers for the information needed. See also Cellular Data Setup.</p> ▶ Manage existing connections <p>Edits existing mobile data connection to Internet.</p> 	My Work Network	<p>Creates mobile data connection to an internal network (intranet) or a VPN. For enterprise network to access Internet, proxy server setting which is usually required is supported.</p> <ul style="list-style-type: none"> ▶ Add a new modem connection <p>Creates a mobile data connection to internal network (intranet) or VPN. Request network administrator for the information needed.</p> ▶ Add a new VPN server connection <p>Sets up a VPN connection. Request your VPN administrator for the details required.</p> <p>After a VPN is set up, Add a new VPN server connection changes to Edit my VPN servers.</p> ▶ Set up my proxy server <p>Sets up the proxy server by which an enterprise network connects to Internet.</p> <p>After a proxy server is set up, Set up my proxy server changes to Edit my proxy server.</p> ▶ Manage existing connections <p>Edits existing mobile data connection to internal network (intranet) or VPN. Request your network administrator for the related information.</p>
Setting	Description						
My ISP	<p>Sets up mobile data connection to the Internet. It provides two links – Add a new modem connection and Manage existing connection. The latter is only available after a connection is set up. See also Edit & Add Access Points.</p> <ul style="list-style-type: none"> ▶ Add a new modem connection <p>Creates a mobile data connection to Internet. Request your mobile carriers for the information needed. See also Cellular Data Setup.</p> ▶ Manage existing connections <p>Edits existing mobile data connection to Internet.</p> 						
My Work Network	<p>Creates mobile data connection to an internal network (intranet) or a VPN. For enterprise network to access Internet, proxy server setting which is usually required is supported.</p> <ul style="list-style-type: none"> ▶ Add a new modem connection <p>Creates a mobile data connection to internal network (intranet) or VPN. Request network administrator for the information needed.</p> ▶ Add a new VPN server connection <p>Sets up a VPN connection. Request your VPN administrator for the details required.</p> <p>After a VPN is set up, Add a new VPN server connection changes to Edit my VPN servers.</p> ▶ Set up my proxy server <p>Sets up the proxy server by which an enterprise network connects to Internet.</p> <p>After a proxy server is set up, Set up my proxy server changes to Edit my proxy server.</p> ▶ Manage existing connections <p>Edits existing mobile data connection to internal network (intranet) or VPN. Request your network administrator for the related information.</p> 						
Advanced tabbed page	<p>Featured settings are:</p> <table border="1" data-bbox="507 1749 1362 1966"> <thead> <tr> <th data-bbox="507 1749 746 1816">Setting</th> <th data-bbox="746 1749 1362 1816">Destription</th> </tr> </thead> <tbody> <tr> <td data-bbox="507 1816 746 1895">Select Networks</td> <td data-bbox="746 1816 1362 1895">Sets which network to auto use when accessing Internet or a private network.</td> </tr> <tr> <td data-bbox="507 1895 746 1966">Dialing Rules...</td> <td data-bbox="746 1895 1362 1966">Sets where you are dialing from so you don't have to create a new connection on a different location.</td> </tr> </tbody> </table>	Setting	Destription	Select Networks	Sets which network to auto use when accessing Internet or a private network.	Dialing Rules...	Sets where you are dialing from so you don't have to create a new connection on a different location.
Setting	Destription						
Select Networks	Sets which network to auto use when accessing Internet or a private network.						
Dialing Rules...	Sets where you are dialing from so you don't have to create a new connection on a different location.						

	Exceptions...	Enters the address of the intranet to access in case it includes a period.
--	---------------	--

8.2.2. PERSONAL FOLDER

This section guides to **Personal Folder** .

Open Start screen, tap **Settings** | **Personal**.

Personal folder opens:

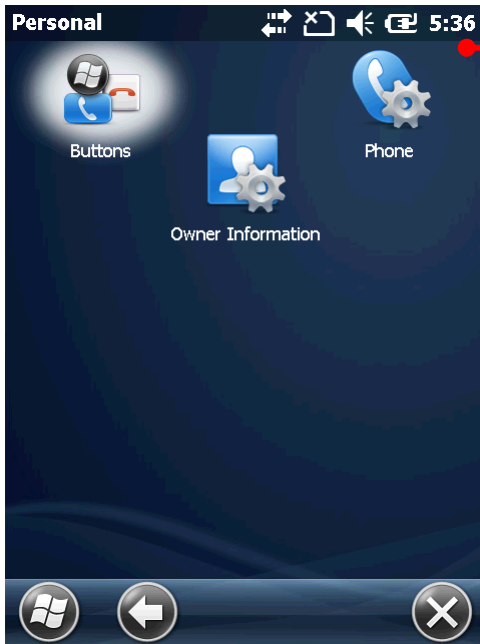

Personal folder opens



OWNER INFORMATION

Creates contact info about the owner of the mobile computer and also some notes.



PHONE

Accesses phone settings. See [Phone Settings](#).



BUTTONS

Provides two tabs – **Program Buttons** and **Up/Down Control**.

Tabbed Page	Description
Program Buttons	Assigns a button to quick launch an application.
Up/Down Control	An up-down control is a pair of arrow buttons that users tap to increase or decrease a value such as a scroll position or a number displayed in a companion control (called a buddy window). Use this page to customize the delay before repeat and the repeat rate for up/down controls.

8.2.3. SYSTEM FOLDER

This section guides to **System Folder** .

Open Start screen, tap **Settings | System**.

System folder opens:



ABOUT

Views OS information. It features three tabs – **Version**, **Device ID** and **Copyright**.

Tabbed Page	Description
Version	Displays OS version details, and shows brief descriptions of major hardware units.
Device ID	Sets a name and description for the mobile computer, making it easy for other devices to identify it. Change this information if you need to discriminate between different devices of the same model type.
Copyright	Displays legal information of the OS.



BACKLIGHT SETTING

Sets screen and keypad timeout and brightness. Four tabs are featured – **Brightness**, **Battery Power**, **External Power**, and **Profile**.

Tabbed Page	Description										
Brightness	<p>Selects whether to allow manual adjustment of the screen and keypad backlights.</p> <ul style="list-style-type: none"> ▶ Adjust the screen to the dimmest comfortable brightness to save power. See also Adjust Backlight. 										
Battery Power	<p>Sets the screen backlight timeout on battery power and whether to trigger screen/keypad light-up upon pressing a key.</p> <table border="1"> <thead> <tr> <th>Option</th> <th>Default Settings</th> </tr> </thead> <tbody> <tr> <td>Turn off LCD backlight if device is not used for:</td> <td>Checked; 2 min</td> </tr> <tr> <td>Turn off keypad backlight if device is not used for:</td> <td>Checked; 10 sec</td> </tr> <tr> <td>Turn on LCD backlight when a button is pressed or the screen is tapped</td> <td>Checked</td> </tr> <tr> <td>Turn on keypad backlight when a button is pressed</td> <td>Checked</td> </tr> </tbody> </table>	Option	Default Settings	Turn off LCD backlight if device is not used for:	Checked; 2 min	Turn off keypad backlight if device is not used for:	Checked; 10 sec	Turn on LCD backlight when a button is pressed or the screen is tapped	Checked	Turn on keypad backlight when a button is pressed	Checked
Option	Default Settings										
Turn off LCD backlight if device is not used for:	Checked; 2 min										
Turn off keypad backlight if device is not used for:	Checked; 10 sec										
Turn on LCD backlight when a button is pressed or the screen is tapped	Checked										
Turn on keypad backlight when a button is pressed	Checked										
External Power	<p>Sets the screen backlight timeout on external power and whether to trigger screen/keypad light up upon pressing a key.</p> <table border="1"> <thead> <tr> <th>Option</th> <th>Default Settings</th> </tr> </thead> <tbody> <tr> <td>Turn off LCD backlight if device is not used for:</td> <td>Checked; 2 min</td> </tr> <tr> <td>Turn off keypad backlight if device is not used for:</td> <td>Unchecked</td> </tr> <tr> <td>Turn on LCD backlight when a button is pressed or the screen is tapped</td> <td>Checked</td> </tr> <tr> <td>Turn on keypad backlight when a button is pressed</td> <td>Checked</td> </tr> </tbody> </table>	Option	Default Settings	Turn off LCD backlight if device is not used for:	Checked; 2 min	Turn off keypad backlight if device is not used for:	Unchecked	Turn on LCD backlight when a button is pressed or the screen is tapped	Checked	Turn on keypad backlight when a button is pressed	Checked
Option	Default Settings										
Turn off LCD backlight if device is not used for:	Checked; 2 min										
Turn off keypad backlight if device is not used for:	Unchecked										
Turn on LCD backlight when a button is pressed or the screen is tapped	Checked										
Turn on keypad backlight when a button is pressed	Checked										
Profile	Sets backlight profiles or restores them back to default.										



BUTTON ASSIGNMENT

Redefines key functions under keypad's normal and function mode. See [Button Assignment](#) for more details.



CERTIFICATES

Views or deletes the digital certificates used by some applications to access some secured networks. See also [Install Secure Certificates](#).



COM PORT MAPPING

Changes the function each COM port serves. COM ports 1 through 9 are re-assignable. Default settings are as follows:

COM port	Default Settings
COM1	Scan engine (Laser or 2D)
COM2	Bluetooth hardware port
COM3~8	N/A
COM9	GPS hardware port

- ▶ **Default** button restores all COM port settings back to factory default.
- ▶ Upon system reboot, the mobile computer checks whether there is a registry entry for Bluetooth Serial Port Profile (SPP) or Dial-up Profile (DUN). These profiles (if existent) are assigned to fixed ports and cannot be re-assigned.
- ▶ Check if any COM ports are occupied by Bluetooth SPP before editing COM port function.
- ▶ After editing COM port settings, tap **OK** command on the softkey bar. A prompt will appear warning that the system needs to reboot in order to apply settings. Tap **OK** to reboot, or **Cancel** to discard changes.
- ▶ If two ports are assigned the same function, a pop up dialog appears when **OK** is tapped to warn that one of these ports must be changed. .



CONTRAST

Provides a slider to set the contrast for the screen display.

- ▶ Along with [Backlight Setting](#), make adjustments to the screen to achieve a most comfortable display mode.



CUSTOMER FEEDBACK

Submits feedback about Windows Embedded Handheld 6.5 to help Microsoft improve the software for this platform.



ENCRYPTION

Encrypts the files placed on the storage card so the encrypted files are only readable on that specific mobile computer.



ERROR REPORTING

Enables/disables the mobile computer to auto-collect and report errors to Microsoft to help them improve products.



EXTERNAL GPS

Configures external GPS receiver in use by the mobile computer. Three tabs are featured – **Access**, **Programs** and **Hardware**.

Tabbed Page	Description
Access	Enables/disables the system's access to the external GPS device.
Programs	Sets the software port for GPS software and location-aware applications to stream GPS data.
Hardware	Sets the hardware COM port and Baud rate for the external GPS receiver.



GPS MANAGER

Downloads or updates ephemeris data, which is valid for 14 days according to system date and time.

- ▶ The download page shows validity information and a progress bar to indicate download status.
- ▶ Correct time must be set before downloading the ephemeris to ensure data is accurate.
- ▶ The system will check every 24 hours for validity of the ephemeris.

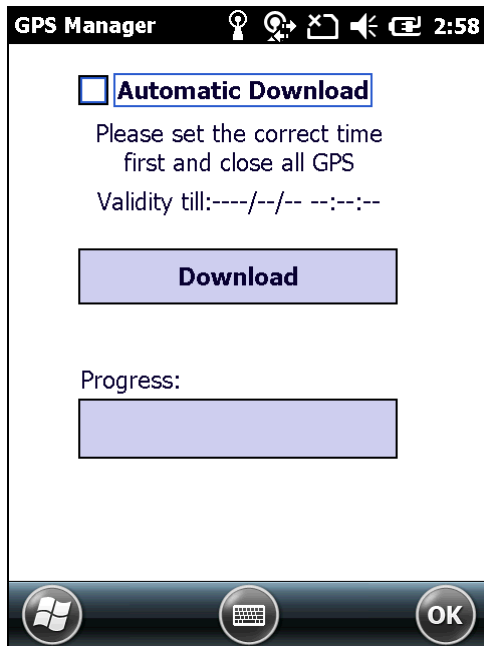

When first opened, click **Download** to store the current version of ephemeris in the system.

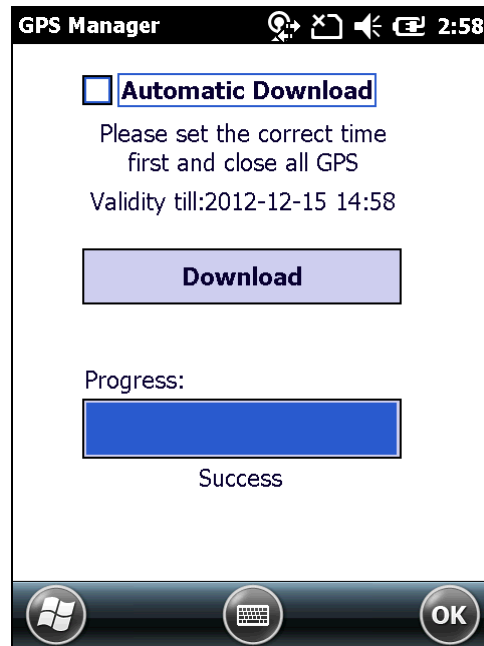

After a successful download, the validity of the current version of ephemeris will be displayed.



MANAGED PROGRAMS

Views the applications remotely installed by your domain's system administrator.



MEMORY

Delivers how the internal/external memories are used. See also [Check Storage](#).



POWER INFORMATION

Displays battery level and sets up power plans. Two tabs are featured – **Battery** and **Advanced**.

Tabbed Page	Description			
Battery	Delivers main battery type and remaining power of both main & backup batteries.			
Advanced	Sets the screen power off time when on battery power and external power. See also Monitor Battery Level .			
	<table border="1"> <thead> <tr> <th>Option</th> <th>Default Settings</th> </tr> </thead> <tbody> <tr> <td>(On battery power) Turn off screen if device is not used for</td> <td>Checked; 2 min</td> </tr> </tbody> </table>	Option	Default Settings	(On battery power) Turn off screen if device is not used for
Option	Default Settings			
(On battery power) Turn off screen if device is not used for	Checked; 2 min			

	(On external power) Turn off screen if device is not used for	Unchecked
--	--	-----------



READER CONFIGURATION

Allows users to set scanner preferences, data output format and destination, and symbologie settings.

A separate utility is provided for barcode reading. See [Launch Reader](#) for details.



REGIONAL SETTINGS

Controls how to display numbers, currency, date, time, etc on the mobile computer. Featured tabs are – **Region**, **Number**, **Currency**, **Time** and **Date**.

Tabbed Page	Description
Region	Sets the region of your locale to display numbers, amount of money, time/date and other info.
Number	Sets how to display numbers.
Currency	Sets how to display currency symbols and amount of money.
Time	Sets how to display time.
Date	Sets how to display date.



REMOVE PROGRAMS

Views and removes the acquired (non-inherent) applications. See also [Uninstall Applications](#).



SCREEN

Delivers three tabs to set how content is to be displayed on the screen.

Tabbed Page	Description
General	Switches the mobile computer between portrait and landscape mode. Also calibrates the touchscreen.
ClearType	Smoothens the edge of screen fonts.
Text size	Adjusts text size.



SCREEN ROTATION

Selects the modes to enable for screen orientation, and whether to suspend the mobile computer when it is facing down.

Tap each of the following labels to enable/disable the given screen rotation mode.

- ▶ Portrait mode
- ▶ Landscape mode
- ▶ Signature mode

Tap the following label to enable/disable suspension of the mobile computer when it is turned over and the screen is facing downwards.

- ▶ Suspend when face down



SENSOR CALIBRATION

Calibrates the G-sensor, E-compass and Gyroscope.

Tabbed Page	Description
G-Sensor	Shows a round ball which fixes at the center of a set of circles when the mobile computer is on a level surface, and dislocates when the mobile computer is tilted. The round ball changes from grey to blue once calibration is finished. <ul style="list-style-type: none"> ▶ The mobile computer must be placed on a flat surface before calibration.
E-Compass	Performs calibration of the mobile computer in three directions. Rotate the mobile computer around the three axes as prompted to complete calibration.
Gyroscope	Shows a round ball inside a series of circles which expand from inside out during calibration. The round ball changes from grey to blue once calibration is finished. <ul style="list-style-type: none"> ▶ The mobile computer must be placed on a flat surface before calibration.



STORAGE INFORMATION

Provides storage status of the internal storage (which is divided into System files and User data) and external storage on the mobile computer.

Label	Description
System	Shows total size and available size of storage under the System directory.
USER_DATA	Shows total size and available size of storage under the USER_DATA directory.
Storage Card	Shows total size and available size of storage under the Storage Card directory.



SYSTEM INFORMATION

Displays some of the mobile computer’s info such as manufacturer, firmware version, MAC address, memory capacity and so on. Tap each node to expand the tree structure list and view data about the given items.

This page also displays the mobile computer’s **Device Config**, a sequence of digits that deliver information about the hardware integrated on the mobile computer. Coding rule is tabulated as below:

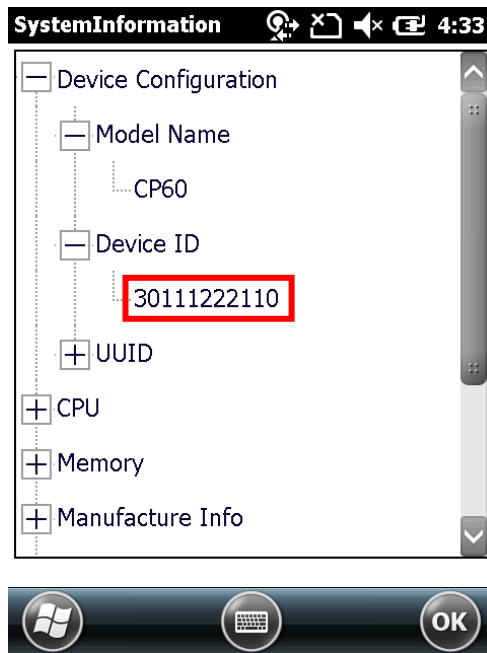

Digit Pair	Hardware	Code
1 st	Barcode Reader	0: None 1: Laser – Class 1 2: Laser – Class 2 3: 2D 4: Long range laser
2 nd	RFID Reader	0: None 1: RFID
3 rd	Bluetooth	0: None 1: Bluetooth
4 th	Wi-Fi	0: None 1: Wi-Fi
5 th	Camera	0: None 1: Camera
6 th	Keypad	0: None 1: 29 Keys 2: QWERTY
7 th	LCD	0: None 1: (Reserved) 2: VGA
8 th	WWAN	0: None 1: WWAN module 2: WWAN module
9 th	GPS	0: None 1: GPS
10 th	Touch panel	0: None 1: 3.5" Touch panel
11 th	Others	0: None (ExtUART) 1: IrDA 2: CIR 3: FIR



TASK MANAGER

Monitors the memory and CPU resources consumed by each running application and cached process. It also closes applications and switches the screen between opened applications. See also [Task Manager](#).



TIME SYNCHRONIZATION

Provides two tabs, **SNTP** and **GPS**.

SNTP tabbed page

Synchronizes the mobile computer's time with an NTP server, either automatically or manually. Users can also select the time period for auto-synchronization. Synchronized time will be written to RTC and system time will be updated.

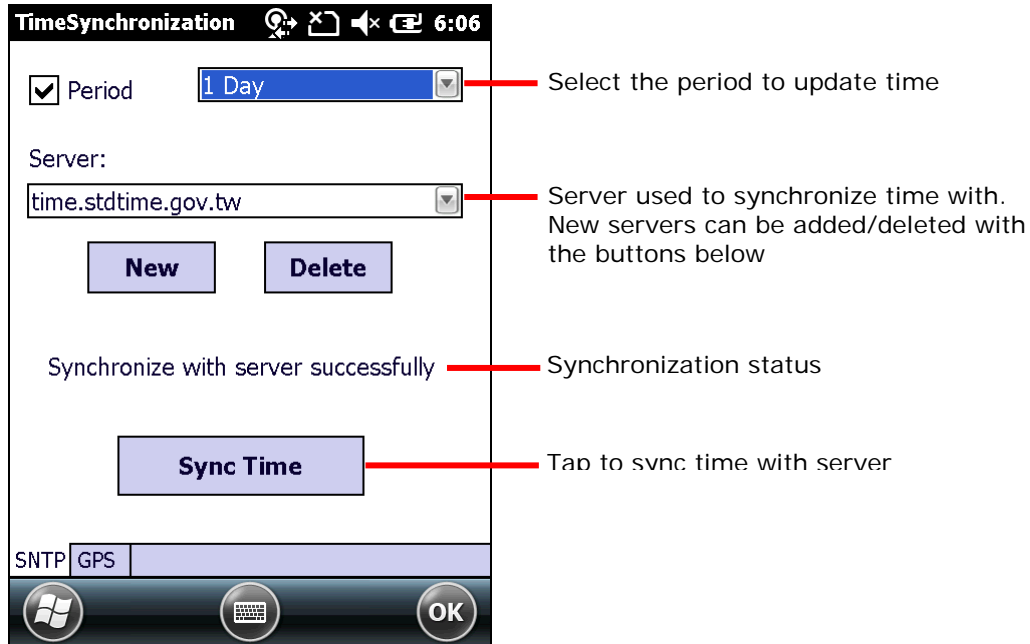

Check Internet connection status if the following synchronization status shows: "Cannot get time information through SNTP".

Note: For auto-synchronization to function properly, Time Synchronization application should be shut down. Close the application when you are finished adjusting the settings.

GPS tabbed page

Gets time information through GPS data packet.

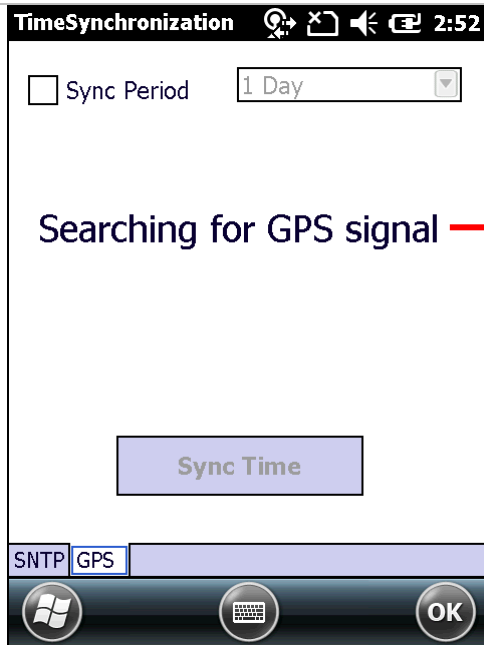

Searching for GPS signal.
Once signal is detected, proceed to
sync time using GPS data



USB CONNECTION

Sets the type of USB connection without re-plugging the USB cable.

- ▶ **ActiveSync Advanced Network Mode:** Sets up ActiveSync connection with PC through RNDIS protocol. This is the default setting.
- ▶ **ActiveSync Serial Mode:** Sets up ActiveSync connection with PC through serial protocol.
- ▶ **Mass Storage – SD Card:** Presents the mobile computer with an SD card installed as a storage device. If no SD card is installed, the directory on the PC will be blank.

Note: Selection of ActiveSync Advanced Network Mode or ActiveSync Serial Mode will be synchronized with settings under **Settings | System | USB to PC**.



USB TO PC

Enables/disables RNDIS (Remote Network Driver Interface Specification). Open **USB to PC** and deselect **Enable advanced network functionality** to disable RNDIS and enable PPP.

Note deselecting **Enable advanced network functionality** will disable [USB Internet Sharing](#).



VERSION VIEWER

Lists version information of the applications and drivers installed on the mobile computer.

**SCU**

Summit Client Utility (SCU) allows changing Wi-Fi settings on the mobile computer, including radio type, access point, encryption and more. Settings are displayed among five tabs:

Tabbed Page	Description
Status	Displays AP information, device IP, connection status and signal strength.
Configuration	Disables/Enables radio and switches between the active profile. Also opens profile settings and global settings.
Diagnostics	Performs diagnostic tests to check connection, and shows information about SCU version.

SPECIFICATIONS

PLATFORM, PROCESSOR & MEMORY

Operating System & CPU

OS Version	Microsoft Windows Embedded Handheld 6.5
CPU	TI DM3730 1GHz Processor

Memory

RAM	512MB DDR SDRAM
Flash	4GB Flash ROM
Expansion Slot	One MicroSDHC card slot, supports up to 32GB

COMMUNICATIONS & DATA CAPTURE

Communications

USB Host/Client	USB 1.1 / USB 2.0
WPAN	Built-in module for Bluetooth version 2.1 + EDR Class II connectivity
WLAN	Built-in module for 802.11 a/b/g/n networking
WWAN	Ordering Option - built-in module for GSM/HSPA+ (Data only)
GPS	Built in GPS module

Data & Image Capture

Digital Camera	5 mega-pixel with auto focus and photoflash
Barcode Reader	Ordering options include <ul style="list-style-type: none">▶ Laser (Symbol SE955)▶ Long Range Laser (Symbol SE965HP)▶ 2D (Symbol SE4500DL)

ELECTRICAL CHARACTERISTICS

Batteries

Main Battery Pack	Standard: 3.7V, 3600 mAh High Capacity: 3.7V, 4400 mAh Rechargeable Li-ion battery Charging time: approximately 4 hours for Standard battery and 6 hours for High Capacity battery
Backup Battery	3.6V, 15 mAh Rechargeable Ni-MH battery Data retention for 30 minutes Charging time: 5 hours

Power Adapter

Power Supply Cord for Snap-on Cable	Input	AC 100~240V, 50/60 Hz
	Output	DC 5 V, 4A
Power Supply Cord for Charging & Comm. Cradle	Input	AC 100~240V, 50/60 Hz
	Output	DC 12V, 3.3A

Operating Time

Standard Battery (1 scan per 20 seconds; 50% backlight, 25°C)

Laser	Wi-Fi mode	Approximately 16 hours
	3G mode	Approximately 9.5 hours
	3G+GPS	Approximately 6 hours
HP Laser	Wi-Fi mode	Approximately 15 hours
	3G mode	Approximately 8 hours
2D	Wi-Fi mode	Approximately 15 hours
	3G mode	Approximately 11 hours

High Capacity Battery (1 scan per 20 seconds; 50% backlight, 25°C)

Laser	Wi-Fi mode	Approximately 18.5 hours
	3G mode	Approximately 10.5 hours
	3G+GPS	Approximately 8 hours
HP Laser	Wi-Fi mode	Approximately 17 hours
	3G mode	Approximately 10 hours
2D	Wi-Fi mode	Approximately 18 hours
	3G mode	Approximately 12 hours

PHYSICAL CHARACTERISTICS

Color Tap Screen Display

Display	3.5" Transflective TFT-LCD, 65K colors, sunlight readable
Resolution	VGA 480 (W) x 640 (H)

Keypad

Layout	Numeric or QWERTY keypad
Backlight	White LED backlight for display and keypad

Notifications

Status LED	Three LEDs for showing scanning good read, radio connection status and battery charging status
Audio	<ul style="list-style-type: none">▶ Integrated with speaker▶ Bluetooth headset supported

Sensors

Built-in Sensors	G-sensor, E-compass, Gyroscope, Light Sensor, Proximity Sensor
------------------	--

Enclosures

Materials	Plastic & metal
Dimensions	182 mm (L) x 83 mm (W) x 44 mm (H) with standard battery 182 mm (L) x 83 mm (W) x 47 mm (H) with high capacity battery
Weight	516g (with standard battery) / 535g (with high capacity battery)

ENVIRONMENTAL CHARACTERISTICS

Temperature

Operating ^{Note}	-20 °C to 50 °C / -4°F to 122°F
Storage	-30 °C to 70 °C / 32°F to 95°F (without battery)
Charging	0 °C to 35 °C / -22°F to 158°F (with battery)

Humidity

Operating	5% to 95%, non-condensing
Storage	20% to 95%, non-condensing

Resistance

Impact Resistance	Multiple 2.4 m (7.8 ft.) drops to concrete on all six sides
Tumble Test	1,000 tumbles (2,000 drops) at 1 m (3.3 ft.) per applicable IEC 60068-2-31 repeated free fall specs
Splash/Dust Resistance	IP65/67 per applicable IEC 60529 sealing specs
Electrostatic Discharge	± 15 kV air discharge, ± 8 kV contact discharge

Note: CipherLab will not be held responsible for the mobile computer's malfunction incurred by the operation outside operating temperature range.

PROGRAMMING SUPPORT

Development Environment & Tools

Integrated Development Environment	Visual Studio 2008 Visual Studio 2005
Software Development Kit	Microsoft SDK System API (DLL) for system configuration Reader API (DLL) for reader configuration

Software & Utilities

CipherLab software package	<ul style="list-style-type: none"> ▶ Reader Configuration ▶ Button Assignment ▶ Signature Capture ▶ Push to Talk ▶ GPS Viewer ▶ SPB SmartShell (optional) ▶ AppLock ▶ MIRROR Browser for web application (product CD) ▶ Terminal Emulation
Third-party software	<ul style="list-style-type: none"> ▶ SOTI MobiControl for remote device control (downloadable from website) ▶ Naurtech CETerm – Terminal emulator (3270, 5250, VT) and industrial web browser (product CD) ▶ SYSDEV Kalipso (product CD)

ACCESSORIES

Accessory Options

- ▶ Snap-on Charging and Communication Cable (USB or RS-232)
- ▶ Charging & Communication Cradle
- ▶ Pistol Grip
- ▶ Belt Holster for CP60 with Pistol Grip
- ▶ Belt Holster with Shoulder Strap for CP60 without Pistol Grip
- ▶ 4-slot Battery Charger
- ▶ Snap-On Car Charging Kit (coming soon)
- ▶ 4-slot Terminal Cradle (coming soon)
- ▶ Vehicle Mount Cradle (coming soon)

SCAN ENGINE SETTINGS

The CipherLab developed utility **Reader Configuration** configures the following reader types:

- ▶ 1D Laser (SE955)
- ▶ 1D Long Range Laser (SE965HP)
- ▶ 2D Imager (SE4500DL)

The reader integrated on the mobile computer is either a 1D or 2D scan engine. When the physical scan key or side trigger is pressed, the mobile computer will read a printed barcode in position. See [Read Printed Barcodes](#) for information on capturing the decoded data.

Note:

- (1) 1D and 2D scan engines don't coexist on the mobile computer because they are both barcode readers and the mobile computer allows one barcode reader only.
 - (2) Run only one reader-controlling utility or application at a time. For example, while running Reader Configuration, avoid running MIRROR Browser, Terminal Emulation, or any other application that uses ReaderDLL.
-

IN THIS CHAPTER

Symbologies Supported.....236

SYMBOLOGIES SUPPORTED

Depending on the scan engine integrated on the mobile computer, supported symbologies will differ as listed below. For details on configuring associated settings, refer to Appendix II and III.

		Laser	2D
Codabar		✓	✓
Code 11		✓	✓
Code 39	Code 39	✓	✓
	Trioptic Code 39	✓	✓
	Italian Pharmacode (Code 32)	✓	✓
Code 93		✓	✓
Code 128	Code 128	✓	✓
	GS1-128 (EAN-128)	✓	✓
	ISBT 128	✓	✓
Code 2 of 5	Chinese 25	✓	✓
	Industrial 25 (Discrete 25)	✓	✓
	Interleaved 25	✓	✓
	Convert Interleaved 25 to EAN-13	✓	✓
	Matrix 25	✗	✓
Composite Code	Composite CC-A/B	✗	✓
	Composite CC-C	✗	✓
	Compostie TLC 39	✗	✓
GS1 DataBar (RSS)	GS1 DataBar-14 (RSS-14)	✓	✓
	GS1 DataBar Limited (RSS Limited)	✓	✓
	GS1 DataBar Expanded (RSS Expanded)	✓	✓
	Convert to UPC/EAN	✓	✓
Inverse	Inverse 1D barcodes	✗	✓
Korean 3 of 5		✗	✓
MSI		✓	✓
Postal Codes	Australian Postal	✗	✓
	Japan Postal	✗	✓
	Netherlands KIX Code	✗	✓
	US Postnet	✗	✓

	US Planet	x	✓
	UK Postal	x	✓
EAN/UPC	EAN-8	✓	✓
	EAN-8 Extend	✓	✓
	EAN-13	✓	✓
	Bookland EAN (ISBN)	✓	✓
	UCC Coupon Extended Code	✓	✓
	ISSN EAN	x	✓
	UPC-A	✓	✓
	UPC-E	✓	✓
	Convert to UPC-A	✓	✓
	UPC-E1	✓	✓
Convert to UPC-A	✓	✓	
2D Symbologies	Aztec	x	✓
	Data Matrix	x	✓
	Maxicode	x	✓
	MicroPDF417	x	✓
	MicroQR	x	✓
	PDF417	x	✓
	QR Code	x	✓

LASER (SE955 & SE965HP)

The tables below list the symbology settings for 1D laser scan engine (SE955) and 1D long range laser scan engine (SE965HP).

SYMBOLGY SETTINGS

Symbology	Description	Default
CODABAR		
CodaBar		
Codabar	Checkbox to enable Codabar decoding.	Enable
Length option	Sets the length of the Codabar symbols to decode. <ul style="list-style-type: none"> ▶ One Fixed length (Length 1) ▶ Two Fixed lengths (Length 1>Length 2) ▶ Max / Min Length (range: 0-255; Length 1<Length 2) ▶ Any Length 	Max / Min Length (4-55)
CLSI	When applied, the CLSI editing strips the start/stop characters and inserts a space after the first, fifth, and tenth characters of a 14-character Codabar barcode. <ul style="list-style-type: none"> ▶ The 14-character barcode length does not include start/stop characters. 	Disable
NOTIS	Sets whether to include start/stop characters in the transmitted data. <ul style="list-style-type: none"> ▶ NOTIS Editing is to strip the start/stop characters, i.e. to disable "Transmit Start/Stop Characters". 	Disable
CODE 11		
Code 11		
Code 11	Checkbox to enable Code 11 decoding.	Enable
Check Digit Option	Sets whether to verify check digits according to the selected option. If the check digits are incorrect, the barcode will not be accepted. <ul style="list-style-type: none"> ▶ Disable ▶ One Check Digit ▶ Two Check Digits 	Disable
Transmit Check Digit	Selects whether to include check digits in the transmitted data. <ul style="list-style-type: none"> ▶ "Check Digit Option" must be enabled. 	Disable
Length option	Sets the length of the Code 11 symbols to decode. <ul style="list-style-type: none"> ▶ One Fixed length (Length 1) ▶ Two Fixed lengths (Length 1>Length 2) ▶ Max / Min Length (range: 0-255; Length 1<Length 2) ▶ Any Length 	Max / Min Length (4-55)
CODE 39		

Code 39		
Code 39	Checkbox to enable Code 39 decoding.	Enable
Trioptic Code 39	Selects whether to decode Trioptic Code 39. ▶ Trioptic Code 39 is a variant of Code 39 used in the marking of computer tape cartridges. It always contains six characters.	Disable
Convert to Code 32	Selects whether to convert decoded data to Italian Pharmacode.	Disable
Code 32 Prefix	Prefix character "A" to Code 32 barcodes. ▶ "Convert to Code 32" must be enabled for this to function properly.	Disable
Verify Check Digit	Selects whether to verify the Modulo 43 check digit. If the check digit is incorrect, the barcode will not be accepted.	Disable
Transmit Check Digit	Decide whether to include the check digit in the data to transmit. ▶ "Verify Check Digit" must be enabled.	Disable
Support Full ASCII	Selects whether to enable Code 39 Full ASCII decoding. Characters are paired to encode the full ASCII character set.	Disable
Length option	Sets the length of the Code 39 symbols to decode. ▶ One Fixed length (Length 1) ▶ Two Fixed lengths (Length 1>Length 2) ▶ Max / Min Length (range: 0-255; Length 1<Length 2) ▶ Any Length	Max / Min Length (4-55)
CODE 93		
Code 93		
Enable Code 93	Checkbox to enable Code 93 decoding.	Enable
Length option	Sets the length of the Code 39 symbols to decode. ▶ One Fixed length (Length 1) ▶ Two Fixed lengths (Length 1>Length 2) ▶ Max / Min Length (range: 0-255; Length 1<Length 2) ▶ Any Length	Max / Min Length (4-55)
CODE 128		
Code 128		
Enable Code 128	Checkbox to enable Code 128 decoding.	Enable
ISBT 128		
Enable ISBT 128	Checkbox to enable ISBT 128 decoding.	Enable
GS1-128		
Enable GS1-128	Checkbox to enable GS1-128 decoding.	Enable
CODE 2 OF 5		
Chinese 25		
Enable Chinese 25	Checkbox to enable Chinese 25 decoding.	Enable
Discrete 25		
Discrete 25	Checkbox to enable Discrete 25 decoding.	Enable

Length option	Sets the length of the Code 39 symbols to decode. <ul style="list-style-type: none"> ▶ One Fixed length (Length 1) ▶ Two Fixed lengths (Length 1>Length 2) ▶ Max / Min Length (range: 0-255; Length 1<Length 2) ▶ Any Length 	Max / Min Length (4-55)
Interleaved 25		
Interleaved 25	Checkbox to enable Interleaved 2 of 5 decoding.	Enable
Length option	Sets the length of the Code 39 symbols to decode. <ul style="list-style-type: none"> ▶ One Fixed length (Length 1) ▶ Two Fixed lengths (Length 1>Length 2) ▶ Max / Min Length (range: 0-255; Length 1<Length 2) ▶ Any Length 	Max / Min Length (4-55)
Verify Check Digit	Decide whether to verify the check digit. If desired, select one of the algorithms below. If the check digit is incorrect, the barcode will not be accepted. <ul style="list-style-type: none"> ▶ Disable ▶ USS Check Digit ▶ OPCC Check Digit 	Disable
Transmit Check Digit	Decide whether to include the check digit in the data being transmitted.	Disable
Convert To EAN-13	Convert a 14-character Interleaved 25 barcode into EAN-13 if the following requirements are met: The barcode must have a leading 0 and a valid EAN-13 check digit.	Disable
GS1 DATABAR		
GS1 DataBar-14		
Enable GS1 DataBar-14	Checkbox to enable GS1 DataBar-14 decoding.	Enable
GS1 DataBar Limited		
Enable GS1 DataBar Limited	Checkbox to enable GS1 DataBar Limited decoding.	Enable
GS1 DataBar Expanded		
Enable GS1 DataBar Expanded	Checkbox to enable GS1 DataBar Expanded decoding.	Enable
Convert to UPC/EAN		

Convert to UPC/EAN	<p>This only applies to GS1 DataBar-14 and GS1 DataBar Limited barcodes not decoded as part of a Composite barcode.</p> <hr/> <p>Convert to EAN-13</p> <p>Strips the leading "010" from barcodes.</p> <ul style="list-style-type: none">▶ The barcode must be composed of a leading "01" as the application identifier (AI) and a first digit of zero. <hr/> <p>Convert to UPC-A</p> <p>Strips the leading "0100" from barcodes.</p> <ul style="list-style-type: none">▶ The barcode must be composed of a leading "01" as the application identifier (AI) and two or more zeros (but not six zeros).	Disable
--------------------	---	---------

MSI		
MSI		
MSI	Checkbox to enable MSI decoding.	Enable
Length option	Sets the length of the MSI symbols to decode. <ul style="list-style-type: none"> ▶ One Fixed length (Length 1) ▶ Two Fixed lengths (Length 1>Length 2) ▶ Max / Min Length (range: 0-255; Length 1<Length 2) ▶ Any Length 	Max / Min Length (4-55)
Check Digit Option	One check digit is mandatory for decoding MSI barcodes. Select whether a second check digit should be verified. If the check digits are incorrect, the barcode will not be accepted. <ul style="list-style-type: none"> ▶ One Check Digit ▶ Two Check Digits 	One Check Digit
Transmit Check Digit	Decide whether to include the check digit in the data being transmitted.	Disable
Algorithm	When two check digits are set for verification, two choices are available for the pair of check digits. <ul style="list-style-type: none"> ▶ Modulo10 / Modulo11 ▶ Double Modulo 10 	Double Modulo 10
UPC/EAN		
EAN-8		
EAN-8	Checkbox to enable EAN-8 decoding.	Enable
EAN-8 Extend	Checkbox to enable converting EAN-8 to EAN-13 format.	Disable
EAN-13		
EAN-13	Checkbox to enable EAN-13 decoding.	Enable
Bookland EAN	Checkbox to enable ISBN decoding. If enabled, select Bookland ISBN Format in the drop-down box below.	Enable
Bookland ISBN Format	Select to decode Bookland data starting with 978 as 10-digit format along with the Bookland check digit, or decode Bookland data starting with 978/979 as EAN-13 format.	Bookland ISBN-10
Transmit Check Digit	Decide whether to include the EAN-13 check digit (the last character in the barcode) in the data being transmitted.	Enable
UPC-A		
UPC-A	Checkbox to enable UPC-A decoding.	Enable
Preamble	Decide whether to include the UPC-A/UPC-E/UPC-E1 preamble System Character (and Country Code) in the data being transmitted. <ul style="list-style-type: none"> ▶ No transmit: transmits none of the above ▶ Transmit System Character: transmits system number only ▶ Transmit Sys. Character and Country Code: transmits system number and country code 	Transmit System Character
Transmit Check Digit	Decide whether to include the UPC-A check digit (the last character in the barcode) in the data being transmitted.	Enable
UPC-E		

UPC-E	Checkbox to enable UPC-E decoding.	Enable
Preamble	Decide whether to include the UPC-A/UPC-E/UPC-E1 preamble System Character (and Country Code) in the data being transmitted. <ul style="list-style-type: none"> ▶ No transmit: transmits none of the above ▶ Transmit System Character: transmits system number only ▶ Transmit Sys. Character and Country Code: transmits system number and country code 	Transmit System Character
Convert to UPC-A	The UPC-E barcode will be expanded into UPC-A format, and the next process will follow the settings configured for UPC-A.	Disable
Transmit Check Digit	Decide whether to include the UPC-E1 check digit (the last character in the barcode) in the data being transmitted.	Enable
UPC-E1		
UPC-E1	Checkbox to enable UPC-E1 decoding.	Disable
Preamble	Decide whether to include the UPC-A/UPC-E/UPC-E1 preamble System Character (and Country Code) in the data being transmitted. <ul style="list-style-type: none"> ▶ No transmit: transmits none of the above ▶ Transmit System Character: transmits system number only ▶ Transmit Sys. Character and Country Code: transmits system number and country code 	Transmit System Character
Convert to UPC-A	The UPC-E1 barcode will be expanded into UPC-A format, and the next process will follow the settings configured for UPC-A.	Disable
Transmit Check Digit	Decide whether to include the UPC-E1 check digit (the last character in the barcode) in the data being transmitted.	Enable
General Preference		
Support Coupon Code	Reads UPC-A barcodes starting with "5", EAN-13 barcodes starting with "99", and UPC-A/EAN-128 Coupon Codes. <ul style="list-style-type: none"> ▶ UPC-A, EAN-13, and GS1-128 must be enabled first! ▶ Use "Addon Redundancy" to control auto-discrimination of the GS1-128 (right half) of a coupon code. 	Disable
EAN Addon Option	Decide whether to decode EAN-8, EAN-13 with addons (including Addon 2 and 5). <ul style="list-style-type: none"> ▶ Ignore Addon ▶ Decode only with addons ▶ Auto-discriminate 	Ignore Addon
EAN Addon Redundancy	When "Auto-discriminate" is applied, decide the number of times of supplementary decoding the same barcode to count as a valid read. Configurable between 2 and 30.	10
UPC Addon Option	Decide whether to decode UPC-E0, UPC-E1, UPC-A with addons (including Addon 2 and 5). <ul style="list-style-type: none"> ▶ Ignore Addon ▶ Decode only with addons ▶ Auto-discriminate 	Ignore Addon

UPC Addon Redundancy	When "Auto-discriminate" is applied, decide the number of times of supplementary decoding the same barcode to count as a valid read. Configurable between 2 and 30.	10										
UPC Security Level	<p>Sets the security level to ensure decoding accuracy considering the printed quality of the barcodes such as Code 128, Code 93, and UPC/EAN. The higher the level is, the more security is ensured. Options are:</p> <table border="1"> <thead> <tr> <th>Level</th> <th>Description</th> </tr> </thead> <tbody> <tr> <td>0</td> <td>With this default, the scan engine is aggressive enough to decode most "in-spec" barcodes.</td> </tr> <tr> <td>1</td> <td>Select this level if misdecodes have occurred. It fixes most misdecodes.</td> </tr> <tr> <td>2</td> <td>Select this level if Level 1 should fail to eliminate misdecodes.</td> </tr> <tr> <td>3</td> <td>Select this level if Security Level 2 should fail to prevent misdecodes. However, as this level actually impairs the decoding ability of scan engine, it'd be better to improve the barcode's print quality if this level should be needed.</td> </tr> </tbody> </table>	Level	Description	0	With this default, the scan engine is aggressive enough to decode most "in-spec" barcodes.	1	Select this level if misdecodes have occurred. It fixes most misdecodes.	2	Select this level if Level 1 should fail to eliminate misdecodes.	3	Select this level if Security Level 2 should fail to prevent misdecodes. However, as this level actually impairs the decoding ability of scan engine, it'd be better to improve the barcode's print quality if this level should be needed.	Level 0
Level	Description											
0	With this default, the scan engine is aggressive enough to decode most "in-spec" barcodes.											
1	Select this level if misdecodes have occurred. It fixes most misdecodes.											
2	Select this level if Level 1 should fail to eliminate misdecodes.											
3	Select this level if Security Level 2 should fail to prevent misdecodes. However, as this level actually impairs the decoding ability of scan engine, it'd be better to improve the barcode's print quality if this level should be needed.											

MISCELLANEOUS

Laser Engine	Description	Default
Miscellaneous Options		
AIM Code ID character	<p>Decide whether to include AIM Code ID in the data. Each AIM Code ID contains a three-character string "]cm":</p> <ul style="list-style-type: none"> ▶] = Flag Character (ASCII 93) ▶ c = Code Character (see below) ▶ m = Modifier Character (see below) 	Disable

AIM CODE ID - CODE CHARACTERS

Code Character	Code Type
A	Code 39, Code 39 Full ASCII, Code 32
C	Code 128, Coupon (Code 128 portion)
d	Data Matrix
E	UPC/EAN, Coupon (UPC portion)
e	GS1 DataBar (RSS)
F	Codabar
G	Code 93
H	Code 11
I	Interleaved 25
L	PDF417, Macro PDF417, Micro PDF417

M	MSI
Q	QR Code, MicroQR
S	Industrial 25 (Discrete 25), IATA 2 of 5
U	Maxicode
X	Code 39 Trioptic, Bookland EAN, Matrix 25, US Postnet, US Planet, UK Postal, Japan Postal, Australian Postal, Dutch Postal
z	Aztec

AIM CODE ID - MODIFIER CHARACTERS

Code Type	Option Value	Option
Code 39	0	No check character or Full ASCII processing.
	1	Check digit has been verified.
	3	Check digit has been verified and stripped.
	4	Full ASCII conversion has been performed.
	5	Result of option values 4 and 1.
	7	Result of option values 4 and 3.
Code 128	0	Standard data packet. No Function Code 1 "FNC1" in the first character position.
	1	Function Code 1 "FNC1" in the first character position.
	2	Function Code 1 "FNC1" in the second character position.
Interleaved 25	0	No check digit processing.
	1	Check digit has been verified.
	3	Check digit has been verified and stripped.
Codabar	0	No check digit processing.
Code 93	0	Always transmit 0.
MSI	0	Modulo 10 check digit verified and transmitted.
	1	Modulo 10 check digit verified but not transmitted.
Industrial (Discrete 25)	25 0	Always transmit 0.
UPC/EAN	0	Standard data packet in full EAN country code format, which is 13 digits for UPC-A and UPC-E (not including addons).
	3	Standard data packet with two-digit or five-digit addons.
	4	EAN-8 data packet.
	A UPC-A with Addon 2 barcode, 012345678905-10, is transmitted to the host as a 18-character string, 1E3001234567890510 .	
Bookland EAN	0	Always transmit 0.
Trioptic Code 39	0	Always transmit 0.
Code 11	0	Single check digit (has been verified.)
	1	Two check digits (has been verified.)

	3	Check digit has been verified but not transmitted.
GS1 DataBar (RSS)	0	Always transmit 0.
		RSS-14 and RSS Limited will be transmitted with an Application Identifier "01". For example, an RSS-14 barcode, 10012345678902, is transmitted as $\text{1e}00110012345678902$.

Note: In EAN-128 emulation mode, RSS is transmitted using Code 128 rules (= "Jc1").

EAN.UCC Composites (RSS, EAN-128, 2D portion of UPC composite)	Native mode transmission	
	0	Standard data packet
	1	Data packet containing the data following an encoded symbol separator character.
	2	Data packet containing the data following an escape mechanism character. The data packet does not support the ECI protocol.
	3	Data packet containing the data following an escape mechanism character. The data packet supports the ECI protocol.
	EAN-128 emulation	
1	Data packet is a EAN-128 barcode (= data is preceded with "Jc1").	

Note: UPC portion of composite is transmitted using UPC rules.

PDF417, Micro PDF417	0	Scan engine is set to conform to protocol defined in 1994 PDF417 symbology specifications. <ul style="list-style-type: none"> ▶ When this option is transmitted, the receiver cannot reliably determine whether ECIs have been invoked or whether data byte 92_{DEC} has been doubled in transmission.
	1	Scan engine is set to follow the ECI protocol (Extended Channel Interpretation). All data characters 92_{DEC} are doubled.
	2	Scan engine is set for Basic Channel operation (no escape character transmission protocol). Data characters 92_{DEC} are not doubled. <ul style="list-style-type: none"> ▶ When decoders are set to this mode, unbuffered Macro symbols and symbols requiring the decoder to convey ECI escape sequences cannot be transmitted.
	3	The barcode contains a EAN-128 symbol, and the first codeword is 903-907, 912, 914, 915.
	4	The barcode contains a EAN-128 symbol, and the first codeword is in the range 908-909.
	5	The barcode contains a EAN-128 symbol, and the first codeword is in the range 910-911.
	A PDF417 barcode, ABCD, with no transmission protocol enabled, is transmitted as $\text{JL}2\text{ABCD}$.	
Data Matrix	0	ECC 000-140, not supported.

	1	ECC 200.
	2	ECC 200, FNC1 in first or fifth position.
	3	ECC 200, FNC1 in second or sixth position.
	4	ECC 200, ECI protocol implemented.
	5	ECC 200, FNC1 in first or fifth position, ECI protocol implemented.
	6	ECC 200, FNC1 in second or sixth position, ECI protocol implemented.
Maxicode	0	Mode 4 or 5
	1	Mode 2 or 3
	2	Mode 4 or 5, ECI protocol implemented.
	3	Mode 2 or 3, ECI protocol implemented in secondary message.
QR Code	0	Model 1
	1	Model 2 / MicroQR ECI protocol not implemented.
	2	Model 2, ECI protocol implemented.
	3	Model 2, ECI protocol not implemented, FNC1 implied in first position.
	4	Model 2, ECI protocol implemented, FNC1 implied in first position.
	5	Model 2, ECI protocol not implemented, FNC1 implied in second position.
	6	Model 2, ECI protocol implemented, FNC1 implied in second position
Aztec	0	Aztec symbol.
	C	Aztec Rune symbol.

Note: For JPEG files, these BPP settings are ignored for it always uses 8 bits per pixel!

2D IMAGER (SE4500DL)

The tables below list the symbology settings for 2D imager (SE4500DL).

SYMBOLGY SETTINGS

1D SYMBOLOGIES

Symbology	Description	Default
CODABAR		
CodaBar		
Codabar	Checkbox to enable Codabar decoding.	Enable
Length option	Sets the length of the Codabar symbols to decode. <ul style="list-style-type: none"> ▶ One Fixed length (Length 1) ▶ Two Fixed lengths (Length 1>Length 2) ▶ Max / Min Length (range: 0-255; Length 1<Length 2) ▶ Any Length 	Max / Min Length (4-55)
CLSI	When applied, the CLSI editing strips the start/stop characters and inserts a space after the first, fifth, and tenth characters of a 14-character Codabar barcode. <ul style="list-style-type: none"> ▶ The 14-character barcode length does not include start/stop characters. 	Disable
NOTIS	Sets whether to include start/stop characters in the transmitted data. <ul style="list-style-type: none"> ▶ NOTIS Editing is to strip the start/stop characters, i.e. to disable "Transmit Start/Stop Characters". 	Disable
CODE 11		
Code 11		
Code 11	Checkbox to enable Code 11 decoding.	Enable
Check Digit Option	Sets whether to verify check digits according to the selected option. If the check digits are incorrect, the barcode will not be accepted. <ul style="list-style-type: none"> ▶ Disable ▶ One Check Digit ▶ Two Check Digits 	Disable
Transmit Check Digit	Selects whether to include check digits in the transmitted data. <ul style="list-style-type: none"> ▶ Check Digit Option" must be enabled. 	Disable
Length option	Sets the length of the Code 11 symbols to decode. <ul style="list-style-type: none"> ▶ One Fixed length (Length 1) ▶ Two Fixed lengths (Length 1>Length 2) ▶ Max / Min Length (range: 0-255; Length 1<Length 2) ▶ Any Length 	Max / Min Length (4-55)

CODE 39		
Code 39		
Code 39	Checkbox to enable Code 39 decoding.	Enable
Trioptic Code 39	Selects whether to decode Trioptic Code 39. ▶ Trioptic Code 39 is a variant of Code 39 used in the marking of computer tape cartridges. It always contains six characters.	Disable
Convert to Code 32	Selects whether to convert decoded data to Italian Pharmacode.	Disable
Code 32 Prefix	Prefix character "A" to Code 32 barcodes. ▶ "Convert to Code 32" must be enabled for this to function properly.	Disable
Verify Check Digit	Selects whether to verify the Modulo 43 check digit. If the check digit is incorrect, the barcode will not be accepted.	Disable
Transmit Check Digit	Decide whether to include the check digit in the data to transmit. ▶ "Verify Check Digit" must be enabled.	Disable
Support Full ASCII	Selects whether to enable Code 39 Full ASCII decoding. Characters are paired to encode the full ASCII character set.	Disable
Length option	Sets the length of the Code 39 symbols to decode. ▶ One Fixed length (Length 1) ▶ Two Fixed lengths (Length 1>Length 2) ▶ Max / Min Length (range: 0-255; Length 1<Length 2) ▶ Any Length	Max / Min Length (4-55)
CODE 93		
Code 93		
Enable Code 93	Checkbox to enable Code 93 decoding.	Enable
Length option	Sets the length of the Code 39 symbols to decode. ▶ One Fixed length (Length 1) ▶ Two Fixed lengths (Length 1>Length 2) ▶ Max / Min Length (range: 0-255; Length 1<Length 2) ▶ Any Length	Max / Min Length (4-55)
CODE 128		
Code 128		
Enable Code 128	Checkbox to enable Code 128 decoding.	Enable
GS1-128		
Enable GS1-128	Checkbox to enable GS1-128 decoding.	Enable
ISBT-128		
ISBT 128	Checkbox to enable ISBT 128 decoding.	Enable

Concatenation	Sets whether to enable decoding ISBT-128 by performing concatenation of ISBT data <ul style="list-style-type: none"> ▶ Disable: Does not perform concatenation ▶ Enable: Performs concatenation on all ISBT-128 barcodes. ▶ Auto-discriminate: Auto-discriminates between the ISBT-128 barcodes which require concatenation and those which do not need concatenation. 	Disable
Redundancy	Sets redundancy between 2-20.	10
CODE 2 OF 5		
Chinese 25		
Enable Chinese 25	Checkbox to enable Chinese 25 decoding.	Enable
Discrete 25		
Discrete 25	Checkbox to enable Discrete 25 decoding.	Enable
Length option	Sets the length of the Code 39 symbols to decode. <ul style="list-style-type: none"> ▶ One Fixed length (Length 1) ▶ Two Fixed lengths (Length 1>Length 2) ▶ Max / Min Length (range: 0-255; Length 1<Length 2) ▶ Any Length 	Max / Min Length (4-55)
Interleaved 25		
Interleaved 25	Checkbox to enable Interleaved 2 of 5 decoding.	Enable
Length option	Sets the length of the Code 39 symbols to decode. <ul style="list-style-type: none"> ▶ One Fixed length (Length 1) ▶ Two Fixed lengths (Length 1>Length 2) ▶ Max / Min Length (range: 0-255; Length 1<Length 2) ▶ Any Length 	Max / Min Length (4-55)
Verify Check Digit	<ul style="list-style-type: none"> ▶ Disable ▶ USS Check Digit ▶ OPCC Check Digit 	Disable
Transmit Check Digit	Decide whether to include the check digit in the data being transmitted.	Disable
Convert To EAN-13	Convert a 14-character Interleaved 25 barcode into EAN-13 if the following requirements are met: The barcode must have a leading 0 and a valid EAN-13 check digit.	Disable
Matrix 25		
Matrix 25	Checkbox to enable Matrix 2 of 5 decoding.	Enable
Length option	Sets the length of the Code 39 symbols to decode. <ul style="list-style-type: none"> ▶ One Fixed length (Length 1) ▶ Two Fixed lengths (Length 1>Length 2) ▶ Max / Min Length (range: 0-255; Length 1<Length 2) ▶ Any Length 	Max / Min Length (4-55)
Redundancy	Sets read redundancy	Disable
Verify Check Digit	Select whether to verify the check digit, which is the last character of the barcode. If the check digit is incorrect, the barcode will not be accepted.	Disable

Transmit Check Digit	Decide whether to include the check digit in the data being transmitted.	Disable
COMPOSITE		
Composite CC-A/B		
Enable Composite CC-A/B	Checkbox to enable Composite CC-A/B decoding.	Disable
Composite CC-C		
Enable Composite CC-C	Checkbox to enable Composite CC-C decoding.	Enable
Composite TLC 39		
Enable TLC 39	Checkbox to enable TLC 39 decoding.	Disable
General Preference		
UPC Composite Mode	<p>UPC barcodes can be "linked" with a 2D barcode during transmission as if they were one barcode.</p> <p>UPC Never Linked</p> <p>Transmit UPC barcodes regardless of whether a 2D barcode is detected.</p> <p>UPC Always Linked</p> <p>Transmit UPC barcodes and the 2D portion. If the 2D portion is not detected, the UPC barcode will not be transmitted.</p> <p>▶ CC-A/B or CC-C must be enabled.</p> <p>Auto-discriminate</p> <p>Transmit UPC barcodes as well as the 2D portion if present.</p>	UPC Always Linked
GS1-128 Emulation Mode	Sets GS1-128 emulation mode for UCC/EAN Composite Codes.	Disable
GS1 DATABAR		
GS1 DataBar-14		
Enable GS1 DataBar-14	Checkbox to enable GS1 DataBar-14 decoding.	Enable
GS1 DataBar Limited		
Enable GS1 DataBar-Limited	Checkbox to enable GS1 DataBar-Limited decoding.	Enable
GS1 DataBar Expanded		
Enable GS1 DataBar-Expanded	Checkbox to enable GS1 DataBar-Expanded decoding.	Enable
Convert to UPC/EAN		

Convert to UPC/EAN	<p>This only applies to GS1 DataBar-14 and GS1 DataBar Limited barcodes not decoded as part of a Composite barcode.</p> <p>Convert to EAN-13</p> <p>Strips the leading "010" from barcodes.</p> <ul style="list-style-type: none"> ▶ The barcode must be composed of a leading "01" as the application identifier (AI) and a first digit of zero. <p>Convert to UPC-A</p> <p>Strips the leading "0100" from barcodes.</p> <ul style="list-style-type: none"> ▶ The barcode must be composed of a leading "01" as the application identifier (AI) and two or more zeros (but not six zeros). 	Disable
INVERSE		
Inverse		
Enable Inverse	Checkbox to enable Inverse 1D decoding.	Disable
KOREAN 3 OF 5		
Korean 3 of 5		
Enable Korean 3 of 5	Checkbox to enable Korean 3 of 5 decoding.	Disable
MSI		
MSI		
MSI	Checkbox to enable MSI decoding.	Enable
Length option	<p>Sets the length of the MSI symbols to decode.</p> <ul style="list-style-type: none"> ▶ One Fixed length (Length 1) ▶ Two Fixed lengths (Length 1 > Length 2) ▶ Max / Min Length (range: 0-255; Length 1 < Length 2) ▶ Any Length 	Max / Min Length (4-55)
Check Digit Option	<p>One check digit is mandatory for decoding MSI barcodes. Select whether a second check digit should be verified. If the check digits are incorrect, the barcode will not be accepted.</p> <ul style="list-style-type: none"> ▶ One Check Digit ▶ Two Check Digits 	One Check Digit
Transmit Check Digit	Decide whether to include the check digit in the data being transmitted.	Disable
Algorithm	<ul style="list-style-type: none"> ▶ When two check digits are set for verification, two choices are available for the pair of check digits. ▶ Modulo10 / Modulo11 ▶ Double Modulo 10 	Double Modulo 10
POSTAL CODE		
Australian Postal		
Enable Australian Postal	Checkbox to enable Australian Postal decoding.	Enable
Japan Postal		
Enable Japan Postal	Checkbox to enable Japan Postal decoding.	Enable

Netherlands KIX Code		
Enable Netherlands KIX Code	Checkbox to enable Netherlands KIX Code decoding.	Enable
US Postnet		
Enable US Postnet	Checkbox to enable US Postnet decoding.	Enable
US Planet		
Enable US Planet	Checkbox to enable US Planet decoding.	Enable
UK Postal		
Enable UK Postal	Checkbox to enable UK Postal decoding.	Enable
General Preference		
US Postal Check Digit	Decide whether to transmit check digit for US Postnet or US Planet.	Enable
UK Postal Check Digit	Decide whether to transmit check digit for UK Postal.	Enable
UPC/EAN		
EAN-8		
EAN-8	Checkbox to enable EAN-8 decoding.	Enable
EAN-8 Extend	Checkbox to enable converting EAN-8 to EAN-13 format.	Disable
EAN-13		
EAN-13	Checkbox to enable EAN-13 decoding.	Enable
Bookland EAN	Checkbox to enable ISBN decoding. If enabled, select Bookland ISBN Format in the drop-down box below.	Enable
Bookland ISBN Format	Decodes Bookland data starting with 978 in 10-digit format along with the Bookland check digit, or Bookland data starting with 978/979 as EAN-13 format.	Bookland ISBN-10
Transmit Check Digit	Decide whether to include the EAN-13 check digit (the last character in the barcode) in the data being transmitted.	Enable
ISSN EAN	Checkbox to enable ISSN EAN decoding.	Disable
UPC-A		
UPC-A	Checkbox to enable UPC-A decoding.	Enable
Preamble	Decide whether to include the UPC-A/UPC-E/UPC-E1 preamble System Character (and Country Code) in the data being transmitted. <ul style="list-style-type: none"> ▶ No transmit: transmits none of the above ▶ Transmit System Character: transmits system number only ▶ Transmit Sys. Character and Country Code: transmits system number and country code 	Transmit System Character
Transmit Check Digit	Decide whether to include the UPC-A check digit (the last character in the barcode) in the data being transmitted.	Enable
UPC-E		
UPC-E	Checkbox to enable UPC-E decoding.	Enable

Preamble	Decide whether to include the UPC-A/UPC-E/UPC-E1 preamble System Character (and Country Code) in the data being transmitted. <ul style="list-style-type: none"> ▶ No transmit: transmits none of the above ▶ Transmit System Character: transmits system number only ▶ Transmit Sys. Character and Country Code: transmits system number and country code 	Transmit System Character
Convert to UPC-A	The UPC-E barcode will be expanded into UPC-A format, and the next process will follow the settings configured for UPC-A.	Disable
Transmit Check Digit	Decide whether to include the UPC-E1 check digit (the last character in the barcode) in the data being transmitted.	Enable
UPC-E1		
UPC-E1	Checkbox to enable UPC-E1 decoding.	Disable
Preamble	Decide whether to include the UPC-A/UPC-E/UPC-E1 preamble System Character (and Country Code) in the data being transmitted. <ul style="list-style-type: none"> ▶ No transmit: transmits none of the above ▶ Transmit System Character: transmits system number only ▶ Transmit Sys. Character and Country Code: transmits system number and country code 	Transmit System Character
Convert to UPC-A	The UPC-E1 barcode will be expanded into UPC-A format, and the next process will follow the settings configured for UPC-A.	Disable
Transmit Check Digit	Decide whether to include the UPC-E1 check digit (the last character in the barcode) in the data being transmitted.	Enable
General Preference		
Support Coupon Code	Reads UPC-A barcodes starting with "5", EAN-13 barcodes starting with "99", and UPC-A/EAN-128 Coupon Codes. <ul style="list-style-type: none"> ▶ UPC-A, EAN-13, and GS1-128 must be enabled first! ▶ Use "Addon Redundancy" to control auto-discrimination of the GS1-128 (right half) of a coupon code. 	Disable
EAN Addon Option	Decide whether to decode EAN-8, EAN-13 with addons (including Addon 2 and 5). <ul style="list-style-type: none"> ▶ Ignore Addon ▶ Decode only with addons ▶ Auto-discriminate 	Ignore Addon
EAN Addon Redundancy	When "Auto-discriminate" is applied, decide the number of times of supplementary decoding the same barcode to count as a valid read. Configurable between 2 and 30.	10
UPC Addon Option	Decide whether to decode UPC-E0, UPC-E1, UPC-A with addons (including Addon 2 and 5). <ul style="list-style-type: none"> ▶ Ignore Addon ▶ Decode only with addons ▶ Auto-discriminate 	Ignore Addon

UPC Addon Redundancy	When "Auto-discriminate" is applied, decide the number of times of supplementary decoding the same barcode to count as a valid read. Configurable between 2 and 30.	10
----------------------	---	----

2D SYMBOLOGIES

Symbology	Description	Default						
Aztec								
Aztec	Selects whether to enable Aztec decoding.	Enable						
Aztec Inverse	Decide whether to decode Aztec Inverse. <table border="1" style="width: 100%; border-collapse: collapse;"> <tr> <td>Regular only</td> </tr> <tr> <td>Decode regular Aztec barcodes only.</td> </tr> <tr> <td>Inverse only</td> </tr> <tr> <td>Decode inverse Aztec barcodes only.</td> </tr> <tr> <td>Inverse Auto-detect</td> </tr> <tr> <td>Decode both regular and inverse Aztec barcodes.</td> </tr> </table>	Regular only	Decode regular Aztec barcodes only.	Inverse only	Decode inverse Aztec barcodes only.	Inverse Auto-detect	Decode both regular and inverse Aztec barcodes.	Regular only
Regular only								
Decode regular Aztec barcodes only.								
Inverse only								
Decode inverse Aztec barcodes only.								
Inverse Auto-detect								
Decode both regular and inverse Aztec barcodes.								
Data Matrix								
Data Matrix	Selects whether to enable Data Matrix decoding.	Enable						
Data Matrix Inverse	Decide whether to decode Data Matrix Inverse. <table border="1" style="width: 100%; border-collapse: collapse;"> <tr> <td>Regular Only</td> </tr> <tr> <td>Decode regular Data Matrix barcodes only.</td> </tr> <tr> <td>Inverse Only</td> </tr> <tr> <td>Decode inverse Data Matrix barcodes only.</td> </tr> <tr> <td>Auto Detect</td> </tr> <tr> <td>Decode both regular and inverse Data Matrix barcodes.</td> </tr> </table>	Regular Only	Decode regular Data Matrix barcodes only.	Inverse Only	Decode inverse Data Matrix barcodes only.	Auto Detect	Decode both regular and inverse Data Matrix barcodes.	Regular Only
Regular Only								
Decode regular Data Matrix barcodes only.								
Inverse Only								
Decode inverse Data Matrix barcodes only.								
Auto Detect								
Decode both regular and inverse Data Matrix barcodes.								
Decode Mirror Images	Selects whether to enable decode mirror images. <table border="1" style="width: 100%; border-collapse: collapse;"> <tr> <td>Never</td> </tr> <tr> <td>Does not decode Data Matrix barcodes that are mirror images.</td> </tr> <tr> <td>Always</td> </tr> <tr> <td>Decodes Data Matrix barcodes that are mirror images.</td> </tr> <tr> <td>Auto</td> </tr> <tr> <td>Decodes both mirrored and unmirrored Data Matrix barcodes.</td> </tr> </table>	Never	Does not decode Data Matrix barcodes that are mirror images.	Always	Decodes Data Matrix barcodes that are mirror images.	Auto	Decodes both mirrored and unmirrored Data Matrix barcodes.	Never
Never								
Does not decode Data Matrix barcodes that are mirror images.								
Always								
Decodes Data Matrix barcodes that are mirror images.								
Auto								
Decodes both mirrored and unmirrored Data Matrix barcodes.								

Maxicode								
MicroPDF417								
MicroPDF417	Selects whether to enable MicroPDF417 decoding.	Disable						
Code 128 Emulation	<p>Transmit data from certain Micro PDF 417 barcodes as if it was encoded in Code 128 barcodes.</p> <ul style="list-style-type: none"> ▶ Transmit AIM code ID character in Miscellaneous options must be enabled first. <p>When applied, the MicroPDF417 barcodes are transmitted with one of these prefixes:</p> <table border="1" style="width: 100%;"> <tr> <td>The first codeword of MicroPDF417 is 903-905:</td> </tr> <tr> <td>The original Code ID "]L3" will be changed to "]C1".</td> </tr> <tr> <td>The first codeword of MicroPDF417 is 908 or 909:</td> </tr> <tr> <td>The original Code ID "]L4" will be changed to "]C2".</td> </tr> <tr> <td>The first codeword of MicroPDF417 is 910 or 911:</td> </tr> <tr> <td>The original Code ID "]L5" will be changed to "]C0".</td> </tr> </table>	The first codeword of MicroPDF417 is 903-905:	The original Code ID "]L3" will be changed to "]C1".	The first codeword of MicroPDF417 is 908 or 909:	The original Code ID "]L4" will be changed to "]C2".	The first codeword of MicroPDF417 is 910 or 911:	The original Code ID "]L5" will be changed to "]C0".	Disable
The first codeword of MicroPDF417 is 903-905:								
The original Code ID "]L3" will be changed to "]C1".								
The first codeword of MicroPDF417 is 908 or 909:								
The original Code ID "]L4" will be changed to "]C2".								
The first codeword of MicroPDF417 is 910 or 911:								
The original Code ID "]L5" will be changed to "]C0".								
MicroQR								
PDF417								
QR Code								
QR Code	Selects whether to enable QR Code decoding.	Enable						
QR Code Inverse	<p>Decide whether to decode QR Code Inverse.</p> <table border="1" style="width: 100%;"> <tr> <td>Regular Only</td> </tr> <tr> <td>Decodes regular QR Code only.</td> </tr> <tr> <td>Inverse Only</td> </tr> <tr> <td>Decodes inverse QR Code only.</td> </tr> <tr> <td>Inverse Auto-detect</td> </tr> <tr> <td>Decodes both regular and inverse QR Codes.</td> </tr> </table>	Regular Only	Decodes regular QR Code only.	Inverse Only	Decodes inverse QR Code only.	Inverse Auto-detect	Decodes both regular and inverse QR Codes.	Regular Only
Regular Only								
Decodes regular QR Code only.								
Inverse Only								
Decodes inverse QR Code only.								
Inverse Auto-detect								
Decodes both regular and inverse QR Codes.								

MISCELLANEOUS

2D Engine	Description	Default
Miscellaneous Options		
AIM Code ID character	<p>Decide whether to include AIM Code ID in the data. Each AIM Code ID contains a three-character string "]cm":</p> <ul style="list-style-type: none"> ▶] = Flag Character (ASCII 93) ▶ c = Code Character ▶ m = Modifier Character ▶ Refer to AIM Code ID – Code Characters. 	Disable

Appendix IV

PHYSICAL KEYPAD REFERENCE TABLE

NUMERIC KEYPAD

Numeric keypad layout:



USING ALPHA, SHIFT & FN KEYS

Key	Normal Mode			Alpha Mode (Lowercase)				Alpha Mode (Uppercase)			
	Key only	Fn+Key	Shift+Key	1 st press	2 nd press	3 rd press	4 th press	1 st press	2 nd press	3 rd press	4 th press
1	1	F1	Shift+1	@	;	:		@	;	:	
2	2	F2	Shift+2	a	b	c		A	B	C	
3	3	F3	Shift+3	d	e	f		D	E	F	
4	4	F4	Shift+4	g	h	i		G	H	I	
5	5	F5	Shift+5	j	k	l		J	K	L	
6	6	F6	Shift+6	m	n	o		M	N	O	
7	7	F7	Shift+7	p	q	r	s	P	Q	R	S
8	8	F8	Shift+8	t	u	v		T	U	V	
9	9	F9	Shift+9	w	x	y	z	W	X	Y	Z
0	0	F11	Shift+0	Space				Space			
*	*	Back Light +	*	/	-			/	-		
#	#	Back Light -	#	%	,			%	,		
Up	Up	Page Up	Up	Up				Up			
Down	Down	Page Down	Down	Down				Down			
Left	Left	Home	Left	Left				Left			
Right	Right	End	Right	Right				Right			

Enter	Enter	Enter	Enter	Enter				Enter			
Tab	Tab	Tab	Tab	Tab				Tab			
Back Space	Back Space	Keypad Lock	Back Space	Back Space				Back Space			
Back Light	Back Light	Back Light	Back Light	Back Light				Back Light			
Send	Send	Start	Send	Send				Send			
End	End	OK	End	End				End			
ESC	ESC	ESC	ESC	ESC				ESC			
-	-	F10	-	+	\$						
.	.	F12	.	.							

QWERTY KEYPAD

QWERTY keypad layout:



USING ALPHA, SHIFT & FN KEYS

Key	Normal	Shift+Key	Fn (Orange)+Key	Alpha (Blue)+Key
Q	q	Q	F1	#
W	w	W	F2	1
E	e	E	F3	2
R	r	R	F4	3
T	t	T	F5	(
Y	y	Y	F6)
U	u	U	F7	/
I	i	I	F8	*
O	o	O	F9	-
P	p	P	F10	+
A	a	A	F11	!
S	s	S	F12	4
D	d	D	F13	5
F	f	F	F14	6
G	g	G	F15	<
H	h	H	F16	>
J	j	J	F17	\
K	k	K	F18	^
L	l	L	F19	%
Z	z	Z	F20	7
X	x	X	F21	8
C	c	C	F22	9
V	v	V	F23	?
B	b	B	F24	:
N	n	N	N/A	;
M	m	M	N/A	=
@	@	@	N/A	"
Backspace	Backspace	Backspace	Keypad Lock	Backspace

&	&	&	N/A	&
Space	Space	Space	Space	Space
Enter	Enter	Enter	Enter	Enter
Tab	Tab	Tab	Tab	Tab
Up	Up	HilightUp	Page Up	Up
Down	Down	HilightDown	Page Down	Down
Left	Left	HilightLeft	Home	Left
Right	Right	HilightRight	End	Right
Backlight	Backlight	Backlight	Backlight	Backlight
Send	Send	Send	Start	Send
End	End	End	OK	End
ESC	ESC	ESC	ESC	ESC
.	.	.	Backlight +	.
,	,	,	Backlight -	-