

EZ-1100/EZ-1200/EZ-1300 User Manual



**FCC COMPLIANCE STATEMENT
FOR AMERICAN USERS**

This equipment has been tested and found to comply with the limits for a CLASS A digital device, pursuant to Part 15 of the FCC Rules. These limits are designed to provide reasonable protection against harmful interference when the equipment is operated in a commercial environment. This equipment generates, uses, and can radiate radio frequency energy and, if not installed and used in accordance with the instructions, may cause harmful interference to radio communications. Operation of this equipment in a residential area is likely to cause harmful interference in which case the user will be required to correct the interference at his/her own expense.

**EMS AND EMI COMPLIANCE STATEMENT
FOR EUROPEAN USERS**

This equipment has been tested and passed with the requirements relating to electromagnetic compatibility based on the standards EN50081-1 (EN55022 CLASS A) and EN61000-4-2/-3/-4/-5/-6/-8/-11 (IEC Teil 2,3,4). The equipment also tested and passed in accordance with the European Standard EN55022 for the both Radiated and Conducted emissions limits.

**EZ-1000 Serial
TO WHICH THIS DECLARATION RELATES
IS IN CONFORMITY WITH THE FOLLOWING STANDARDS**

EN55022 : 1998, CISPR 22 , Class A / EN55024 : 1998 IEC 61000-4 Serial / EN61000-3-2 : 2000 / EN 61000-3-3 : 1995 / CRF 47, Part 15/CISPR 22 3rd Edition : 1997, Class A / ANSI C63.4 : 2001 / CNS 13438, CISPR 22(Class A) / IEC60950 3rd Edition (1999) / GB4943 : 2001 / GB9254 : 1998 / GB17625.1 : 2003

CAUTION

Danger of explosion if battery is incorrectly replaced
Replace only with the equivalent type recommended by the manufacture.
Dispose of used batteries according to the manufacturer's instructions.

Specifications are subject to change without notice.

Warranty Information

All Godex products are sold with warranties. Below is the general information:

PRINTER PRODUCTS:

Printers. All printers (excluding print heads) are warranted against defect in material or workmanship for twelve (12) months from the invoice date.

Proof of shipment date (or Performa Invoice date) is required to validate the warranty period. The warranty becomes void if the equipment is modified, improperly installed, handled or used, damaged by accident or neglect, or if any parts are improperly installed or replaced by the user.

NOTE: Products returned must be packaged in the original or comparable packing and shipping container. In the event equipment is not so packaged or if shipping damage is evident, it will not be accepted for service under warranty. Godex is not responsible for handling and surface transportation costs for return to customers.

Print heads. Since print head wear is part of normal operation, the original print head is covered by a limited warranty of 3 months. Warranty period begins on the invoice date. To qualify for this warranty, the print head must be returned to the factory or to an authorized service center. Customers are not required to purchase Codex supplies (media or ribbons) for warranty qualification. However, if it is determined that the use of other manufacturer supplies has caused any defect in the print head for which a warranty claim is made, the user is responsible for Godex's labor and material charges required to repair the defect. The warranty becomes void if the print head is physically worn or damaged; also if determined man-made scratches under 20x microscope.

Software. Software is warranted to be free of defects in material and workmanship for 30 days from the date of invoice. In the event of notification within the warranty period of defects, Godex will replace the defective CD or documentation.

Parts. All parts, maintenance kits, option kits, and accessories are warranted to be free of defects in material and workmanship for 90 days (except where otherwise denoted) from date of invoice. This warranty becomes void if the item is modified improperly installed, handled or used, or damaged by accident or neglect.

SUPPLIES PRODUCTS:

Supplies are warranted to be free from defect in material and workmanship for a period of six (6) months for media and twelve (12) months for ribbon from the date of shipment by Godex. This is provided the user has complied with storage guidelines, handling, and usage of the supplies in Godex printers.

Godex is obligated under these warranties to furnish parts and labor for the repair or possible replacement of products found to be defective in material or workmanship during the warranty period. Godex may in its discretion issue a credit of any such defective products in such amount, as it deems reasonable.

Warranty Exclusions and Conditions Statement

The warranties provided above are the only warranties applicable. No other warranties, expressed or implied, are given. Godex does not make any IMPLIED WARRANTY OF MERCHANTABILITY OR FITNESS FOR A PARTICULAR PURPOSE in connection with its sale of products or services. It is the desire of Godex to be responsive to specific needs and questions; Godex does not assume responsibility for any specific application to which any products are applied including, but not limited to, compatibility with other equipment. All statements, technical information or recommendations relating to Godex products are based upon tests believed to be reliable yet do not constitute a guaranty or warranty.

The maximum liability for warranty claims is limited to the invoice price of the product claimed defective. Godex does not assume responsibility for delays or replacement or repair of products. Godex shall not under any circumstances be liable to any party for loss of profits, lost data, diminution of good will, or any other special or consequential damages with respect to any claim made under agreement with Godex. Specifically for software, Godex is not liable for any incidental or consequential damages caused by abuse or misapplication of the software or by its use in violation of the international business law and treaty.

No sales person, representative, or agent of Godex is authorized to make any guaranty, warranty, or representation that contradicts the foregoing. Any waiver, alteration, addition or modification to the foregoing warranties must be in writing and signed by an executive officer of Godex to be valid.



Warranty Agreement

To whom it may concern,

Enclosed in the printer package you will find the document titled "Warranty Information." This standard warranty document for Godex International Co., Ltd. barcode printers replaces all warranty documentation that you may find included within the software and documentation CD in this printer package.

Sincerely,

A handwritten signature in cursive script that reads "Daniel Chang".

Daniel Chang
Vice President
Godex International Co., Ltd.

CHAPTER 1 - BARCODE PRINTER.....	8
1-1. Introduction.....	8
1-2. Printer Models	8
1-3. Printer Accessories.....	8
1-4. General Specifications.....	9
1-5. Communication Interface.....	10
1-6. Printer Parts.....	12
CHAPTER 2 - PRINTER INSTALLATION	13
2-1. Ribbon Installation.....	13
2-2. Label Installation.....	14
2-3. Label Roll Core Installation Instruction	15
2-4. Card / Hang tags Installation	16
2-5. USB Installation	16
2-6. USB Uninstallation.....	18
2-7. PC Connection	19
CHAPTER 3 - OPTIONS INSTALLATION	20
3-1. Stripper Parts.....	20
3-2. Stripper Installation.....	20
3-3. Stripper Installation Diagram	22
3-4. Cutter Parts	23
3-5. Cutter Installation.....	23
3-6. Extended Memory Parts	26
3-7. Extended Memory Installation	26
CHAPTER 4 - LED MESSAGE DESCRIPTION.....	28
4-1. LED Status	28
4-2. Feed Key	29
4-3. Self-Test	29
4-4. Dump Mode	30
4-5. Auto Sensing	30
4-6. Direct Thermal / Thermal Transfer Mode Switch.....	30
4-7. See-through Sensor on/off	31
4-8. Error Messages	32
CHAPTER 5 - MAINTENANCE AND ADJUSTMENT.....	33
5-1. Thermal Print Head Cleaning	33
5-2. Thermal Print Head Balance Adjustment	33
5-3. Print Line Adjustment	34
5-4. Adjust the cutter.....	34
5-5. Troubleshooting.....	35

Chapter 1 - Barcode Printer

1-1. Introduction

The Godex EZ-1000 series is a desktop thermal transfer / direct thermal label printer. With plastic outer casing, the EZ-1000 series is designed to be a lightweight and a low cost printer for large variety of printing requirement. Its features are as follows:

- ◆ Direct Thermal and Thermal Transfer Printing Mode
- ◆ Print head density of 8 dots or 12dots per mm (203 or 300 dots per inch)
- ◆ Memory for label, graphics, and fonts download (approximately 100KB)
- ◆ Optional Real Time Clock for time recording and tracking
- ◆ Internal 5" (125mm) label roll capacity and 300M (Max O.D. 64mm) ribbon length (1" core size)
- ◆ Standard 2MB RAM for Maximum 68" print length
- ◆ Optional stripper module for label
- ◆ Optional cutter for ticketing or receipt printing applications
- ◆ Free Bundle of label editing software QLabel-IV

1-2. Printer Models

	
EZ-1100 (203 DPI)	EZ-1200 (203 DPI)
	
EZ-1300 (300 DPI)	

1-3. Printer Accessories

After unpacking, please check the accessories that come with the package, and store them appropriately.

1. Barcode Printer	2. Power Cables (110V and 230V)	3. Switching Power Adapter
4. Parallel Port Cable	5. Serial Port Cable (Optional)	6. USB Cable
7. Label Roll Core	8. Ribbon Shaft (2pcs)	9. Empty Roll Core
10. Label Roll Sample	11. Ribbon Roll Sample	12. Quick Start Guide
13. CD (including Software/Manual/Driver/DLL)		
14. Print Head Cleaning Card	15. Warranty Card / Warranty Information	

*** If a different power supply is used with the printer which has caused damages to the printer itself, then this is not covered as part of the product warranty.**

1-4. General Specifications

Model Name	EZ-1100	EZ-1200	EZ-1300
Resolution	203 dpi (8 dot/mm)		300 dpi (12 dot/mm)
Print Mode	Thermal Transfer / Direct Thermal		Thermal Transfer / Direct Thermal
CPU	16 Bit		
Sensor Location	Moveable, center aligned		
Sensor Type	Reflective		
Sensor Detection	Type: Label gap, black mark, and punch hole sensing. Detection: Label length auto sensing and / or program command setting		
Print Speed	2~4 IPS Standard	2~4 IPS Standard 5~6 IPS can be achieved (media dependant)	2~3 IPS
Print Length	Min. 12mm (0.47"); Max. 1727mm (68")		Min. 12mm (0.47"); Max. 762mm (30")
Print Width	104mm (4.10")		104mm (4.10")
Media	Label Roll OD: Max. 127mm (5") Core Diameter: 1", 1.5", 3" Width: 25mm (1 ") ~ 118mm (4.65") Thickness: 0.06~0.3mm (0.0025"~0.012")		
Ribbon	Length: 300M (981 ft) Max. ribbon roll OD: 64mm (2.52 ") Type: transfer ribbons (wax, hybrid, and resin) in widths of 30mm to 110mm (1.88" to 4.33") Core Inner Diameter: 25.4mm (1")		
Printer Language	EZPL; Firmware Downloadable		
Software	Application: QLabel DLL & Driver: Microsoft Windows 95, 98, Me, NT 4.0, 2000 and XP		
Resident Fonts	9 resident alphanumeric fonts (included OCR A & B) those are expandable 8 times horizontally and vertically. All fonts in 8 directions rotation. 6,8,10,12,14,18,24,30 points		
Fonts Download	Windows Bit-map fonts and Asian fonts downloadable. All fonts in 8 directions rotation.		
Image Handling	PCX, BMP (With QLabel Software Supporting ICO, WMF, JPG, EMF).		
Barcode	Code 39, Code 93, Code 128 (subset A, B, C), UCC/EAN-128 K-Mart, UCC/EAN-128, UPC A / E (add on 2 & 5), I 2 of 5, I 2 of 5 with Shipping Bearer Bars, EAN 8 / 13 (add on 2 & 5), Codabar, Postnet, EAN 128, DUN 14, MaxiCode, HIBC, Plessey, Random Weight, Telepen, FIM, China Postal Code, RPS 128, PDF417 & Datamatrix code (QR code available)		
Interface	Serial, Parallel	Serial, Parallel, USB	
Interface Transmission	Baud rate 4800 ~ 38400, XON/XOFF, DSR/DTR		
Memory	DRAM: 2MB, FLASH: 1MB		
LED Display	LED * 2, Bi-Color Function Key * 1, FEED		
Power	Auto Switching 100/240VAC, 50/60 Hz		
Environment	Operation: 40°F to 104°F (5°C to 40°C) Storage: -40°F to 122°F (-20°C to 50°C)		
Humidity	Operation: 30-85%, non-condensing. Free air. Storage: 10-90%, non-condensing. Free air.		
Cert. Approval	CE, FCC Class A, CCC, CB, CUL, BSMI		
Printer Dimension	Length: 285mm (11.2") Height: 171mm (6.8") Width: 226mm (8.9") Weight: 2.72Kg		

Options	Rotary Cutter Module Stripper Module 1MB Flash Expansion Card + RTC (Real Time Clock) 2 MB Flash Expansion Card + RTC (Real Time Clock) Internal Ethernet Adapter Card
---------	--

Specifications are subject to change without notice.

1-5. Communication Interface

Parallel Interface

Interface cable : Parallel cable compatible with IBM PC

Pin out : See below

PIN NO.	FUNCTION	TRANSMITTER
1	/Strobe	host / printer
2-9	Data 0-7	host
10	/Acknowledge	printer
11	Busy	printer
12	/Paper empty	printer
13	/Select	printer
14	/Auto-Linefeed	host / printer
15	N/C	
16	Signal Gnd	
17	Chasis Gnd	
18	+5V,max 500mA	
19-30	Signal Gnd	host
31	/Initialize	host / printer
32	/Error	printer
33	Signal Ground	
34-35	N/C	
36	/Select-in	host / printer

Serial Interface

Serial Default Setting : 9600 baud rate, no parity, 8 data bits, 1 stop bit, XON/XOFF protocol and RTS/CTS

RS232 HOUSING (9-pin to 9-pin)

DB9 SOCKET			DB9 PLUG
---	1	1	+5V,max 500mA
RXD	2	2	TXD
TXD	3	3	RXD
DTR	4	4	DSR
GND	5	5	GND
DSR	6	6	DTR
RTS	7	7	N/C
CTS	8	8	RTS
RI	9	9	N/C
PC	PRINTER		

NOTE: The total voltage output from parallel port and serial port altogether can not exceed 500mA.

USB Interface

Connector Type : Type B

PIN NO.	1	2	3	4
FUNCTION	USBVCC	D-	D+	GND

1-6. Printer Parts

Please use the following diagrams to identify each printer part.

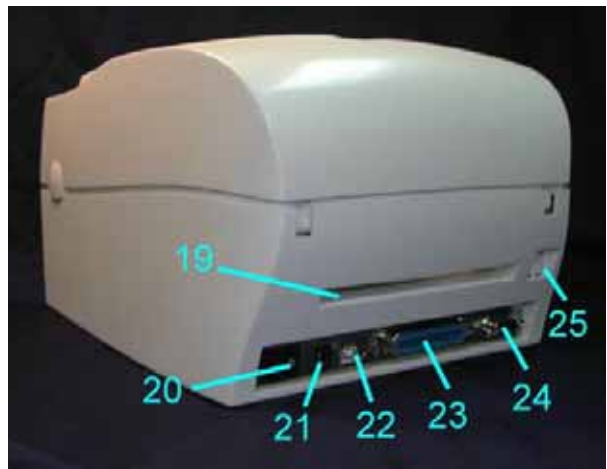
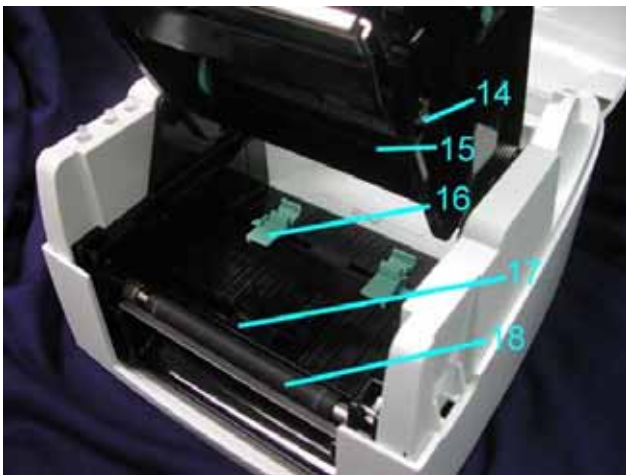
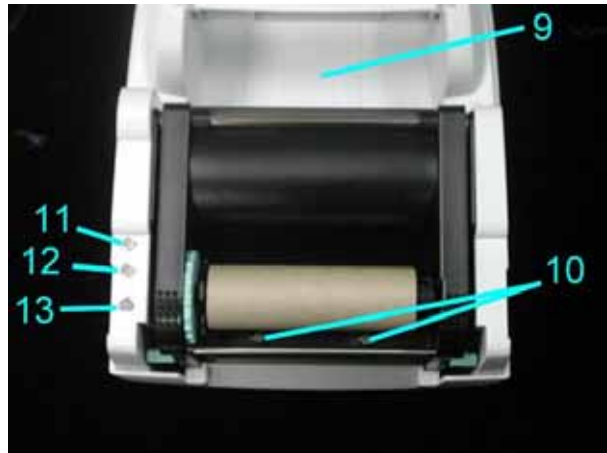
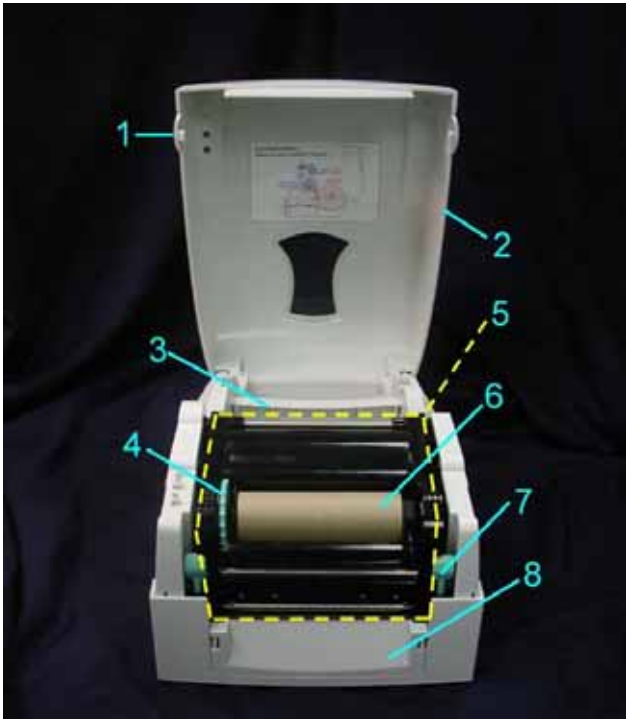



1	Cover Open Button	11	LED Light (Ready)	21	Power Socket
2	Top Cover	12	LED Light (Status)	22	USB Port
3	Label Roll Core	13	FEED Key	23	Parallel Port
4	Ribbon Rewind Wheel	14	Print Line Adj. Gear	24	Serial Port
5	Print Mechanism	15	Ribbon Supply Shaft	25	Ethernet Socket (Option)
6	Ribbon Rewind Shaft + Empty Ribbon Take Up Core	16	Label Guide		
7	Locking Tenon (left/right)	17	Label Sensor		
8	Front Cover Piece	18	Platen Roller		
9	Memory Card Cover	19	Fan-Fold Label Insert		
10	Print Head Pressure Adj. Screw (left/right)	20	Power Switch		

Chapter 2 - Printer Installation



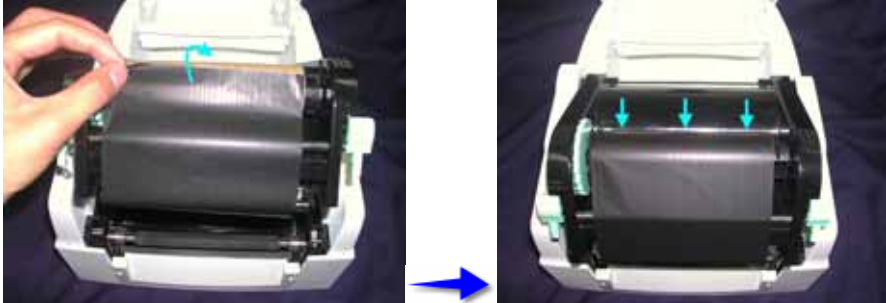
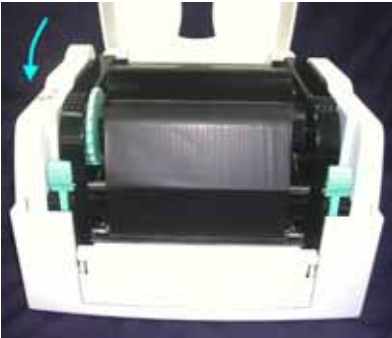

This printer model has the following print modes:

Thermal Transfer (TT):	When printing, ribbon must be installed to transfer the print contents onto the media.
Direct Thermal (DT):	When printing, no ribbon is necessary; it only requires direct thermal media.

2-1. Ribbon Installation

<p>1. Place the printer onto a smooth surface, and open the top cover.</p>	 <p>A top-down view of the printer with its top cover open. Two red arrows point to the hinges on either side of the cover.</p>
<p>2. Loosen and then lift the upper print mechanism by pressing the locking tenons. 3. Take out the ribbon supply shaft and rewind shaft. 4. Place the new ribbon roll onto the ribbon supply shaft.</p>	 <p>Two side-view photographs showing the removal of the old ribbon roll and the installation of a new one. A blue arrow points from the first image to the second.</p>
<p>5. Feed the ribbon from the Ribbon Supply Shaft under the Print Head. 6. Wrap the ribbon around the Ribbon Shaft and stick the ribbon onto the Empty Ribbon Roll Core.</p>	 <p>Two side-view photographs showing the ribbon being fed under the print head and wrapped around the shaft. Red arrows indicate the path of the ribbon. A blue arrow points from the first image to the second.</p>
<p>7. Firmly close the upper print mechanism.</p>	 <p>A top-down view of the printer with the top cover closed. A red arrow points to the cover hinge.</p>

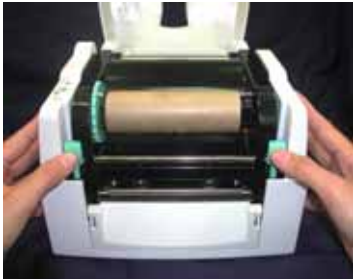
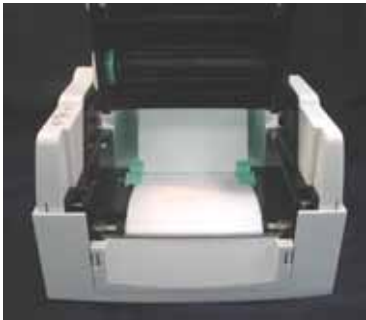
2-2. Label Installation

<p>1. Open the top cover.</p>	
<p>2. Place the label roll onto the Label Roll Core,</p>	
<p>3. Loosen and lift the upper print mechanism by pressing the locking tenons.</p>	
<p>4. Feed the label through the two Label Guides to the Tear-off Bar. 5. Align the label guides to the label edge.</p>	
<p>6. Close the upper print mechanism from the top to finish label installation.</p>	

2-3. Label Roll Core Installation Instruction

(A) 1" roll core installation instruction

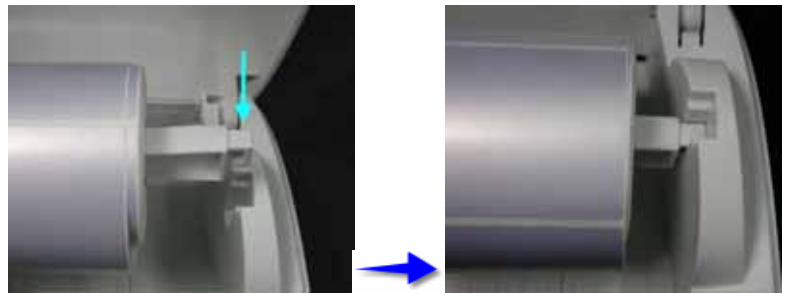

(B) 1.5" roll core installation instruction

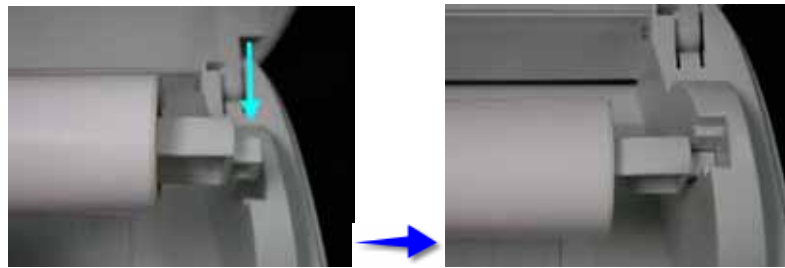

(C) 3" roll core installation instruction

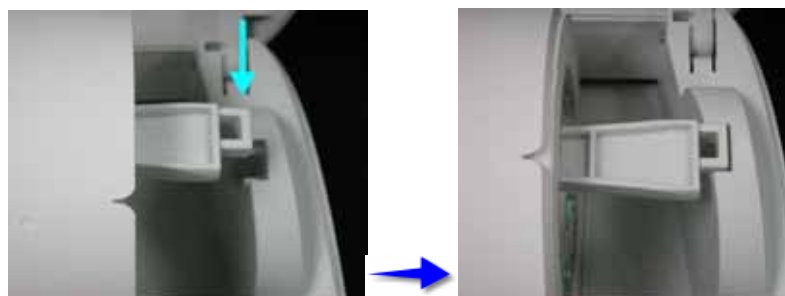
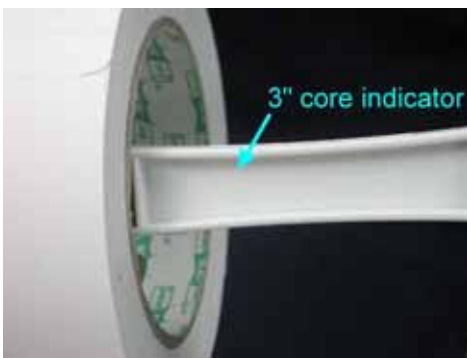

2-4. Card / Hang tags Installation

When installing cord tags, the tag hole must align with the sensor arrow (as indicated in Photo 1), then use the Label Guide to secure the tags.

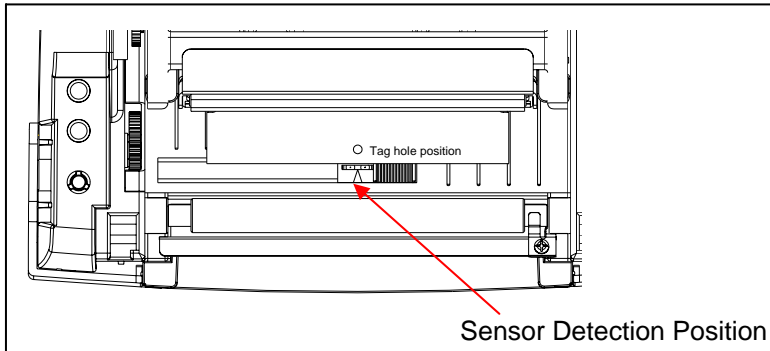

(Photo 1)

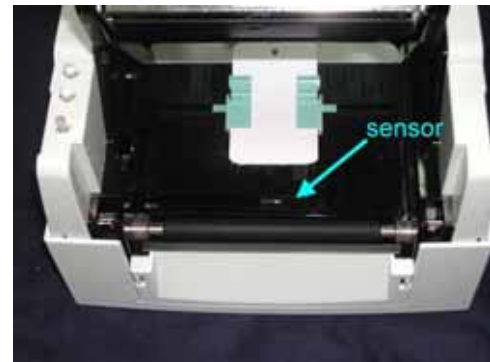

2-5. USB Installation

1. USB is a Plug & Play facility. Once the USB cable is connected from PC to the printer, PC will automatically detect the new device and begin the installation process.



2. Select "Search for a suitable driver for my device [recommended]" and click "Next"



3. Select the location of the driver.

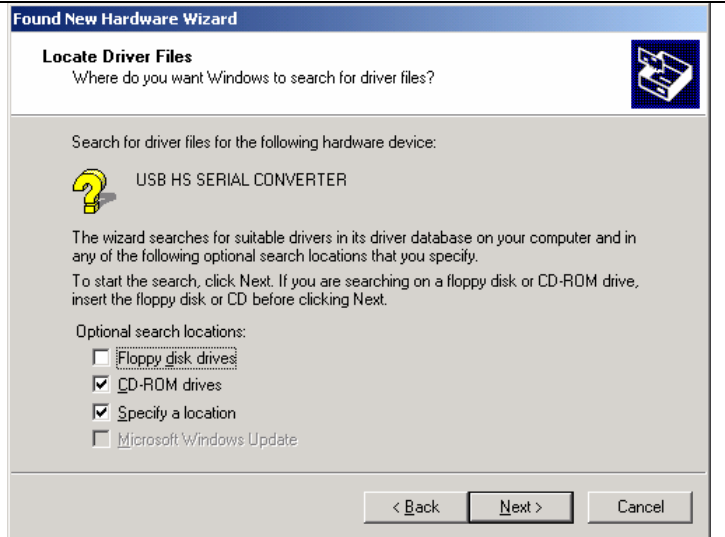

4. When the USB device driver is assigned and saved, click "Next"

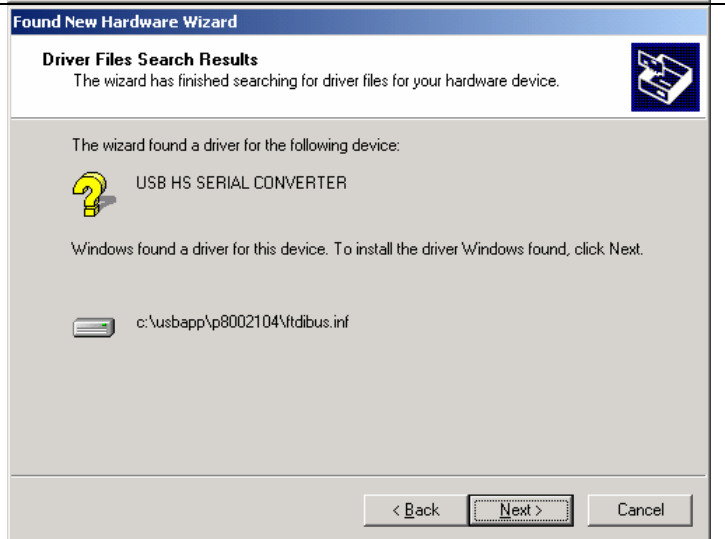

5. The USB device is built on the serial port, therefore make sure the interface setting is specified to the assigned port.



6. Go to Control Panel\System\Device Manager and the USB port will be listed under Ports (COM & LPT). The example from the right hand side indicates that the USB Serial Port is COM3.
7. After the USB driver is installed, the USB device can be used through software (such as QLabel-IV or Godex drivers) to print labels.

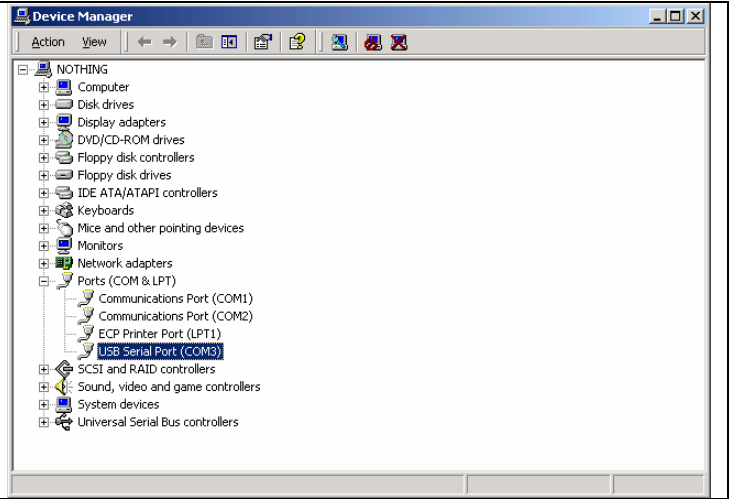

2-6. USB Uninstallation

To remove the USB driver, open "USB Driver" folder and execute the "Ftdiunin" program, the message box on the right hand side will appear. Click "Continue" to remove the USB driver.



2-7. PC Connection

1. Please make sure the printer is powered off.
2. Take the power cable, plug the cable switch to the power socket, and then connect the other end of the cable to the printer power socket.
3. Connect the cable to the parallel port on the printer and on the PC.
4. Power on the printer. The LED light (Ready) should turn green when power is on.

Remark: If you wish to connect with an USB interface, please install the USB driver first.

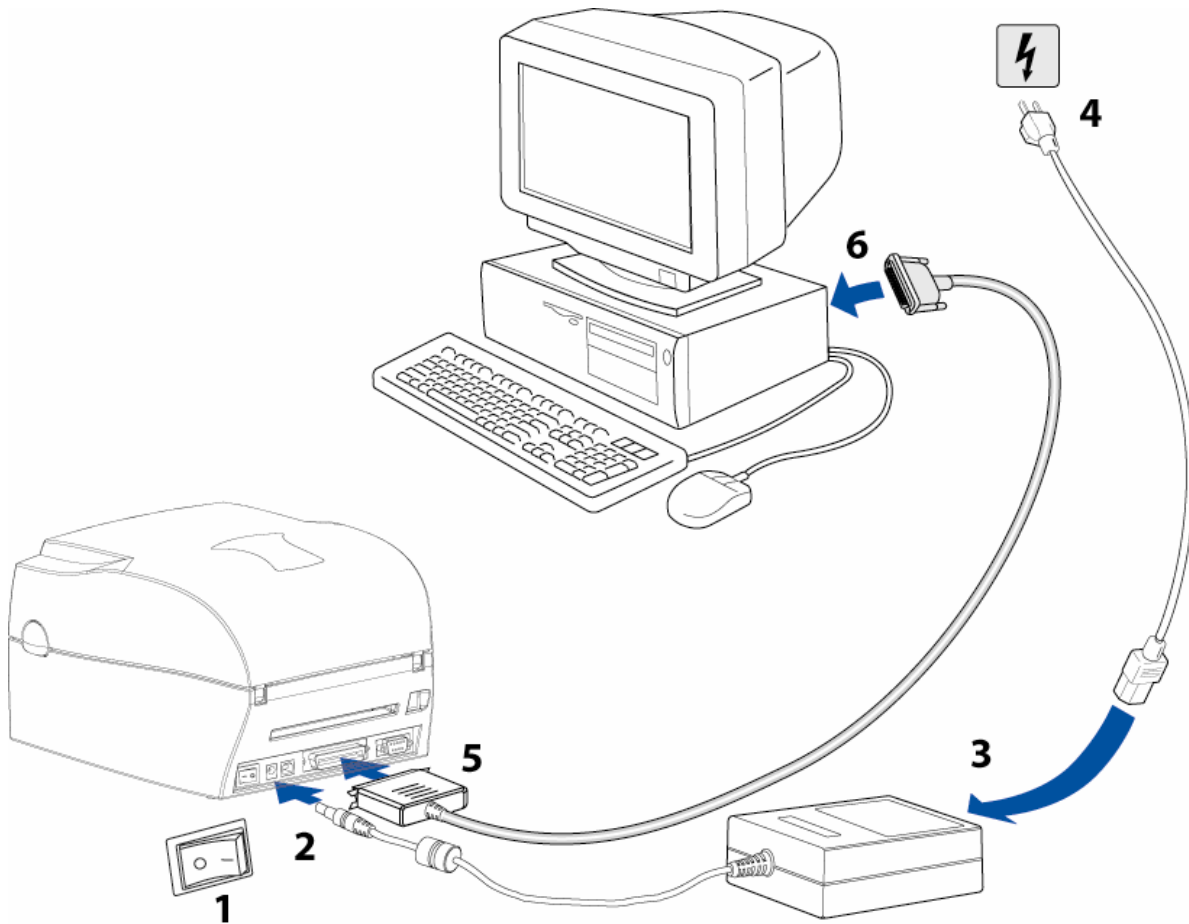

Chapter 3 - Options Installation

3-1. Stripper Parts

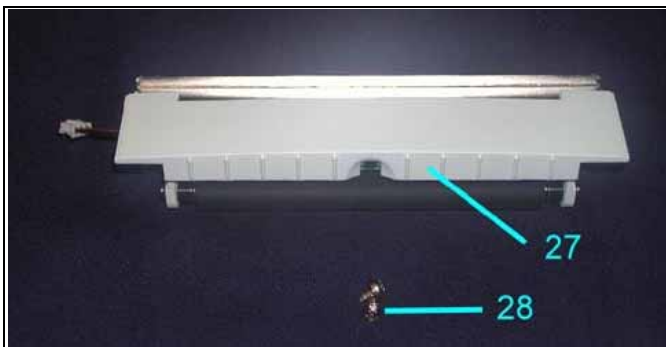

27	Stripper Module
28	Screw (TAP 3*8) x 2pcs

[Note1]: Please power off the printer before installing the stripper module.
 [Note2]: Label liner thickness is recommended to be 0.06mm ± 10% with basic weight 65g/m²±6%.
 [Note3]:Max. peed-off width:110mm
 [Suggestion] When installing the stripper module, set the stop position to 8 in QLabe-III . The E value is 8.

3-2. Stripper Installation

1. Open the top cover by pressing the Cover Open Buttons on both sides.

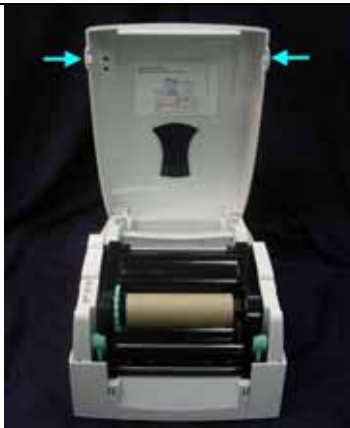

2. Push the front cover piece buttons inward to open.
 3. Lift/take off the front cover piece according to the direction shown in the photo.

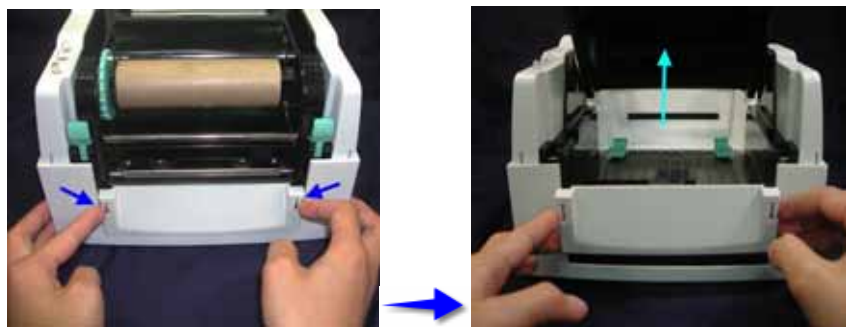

4. Plug in the connector (refer to the right photo).

Note: There are 2 sockets on the converting boards (one is for stripper installation, another is for cutter installation), before plug the connector into socket, please check the pin first.

5. The label / paper used for rewinding purposes is suggested to be at least 30mm in height.

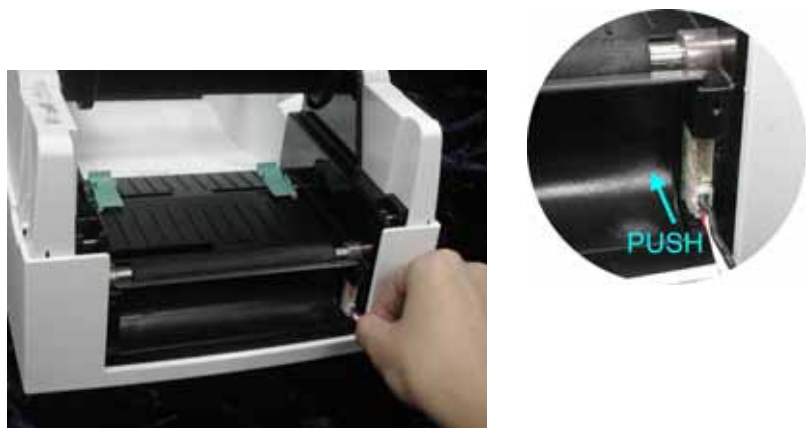

6. Place the right side in first, and then fit the left side.

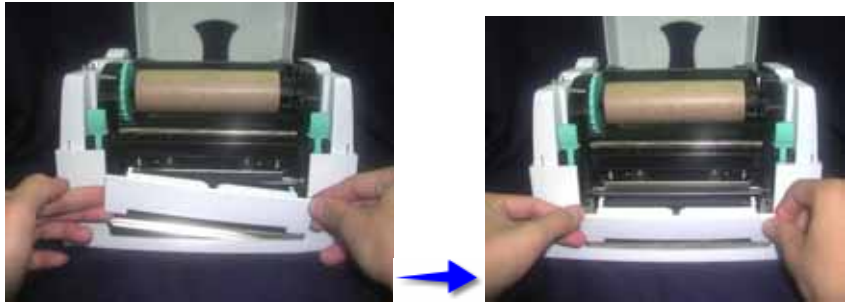

7. Hold the stripper module and tighten the screws (28).



8. Peel off the first label, and feed the liner through the roller and the peel off bracket.
9. Flip close the stripper module.

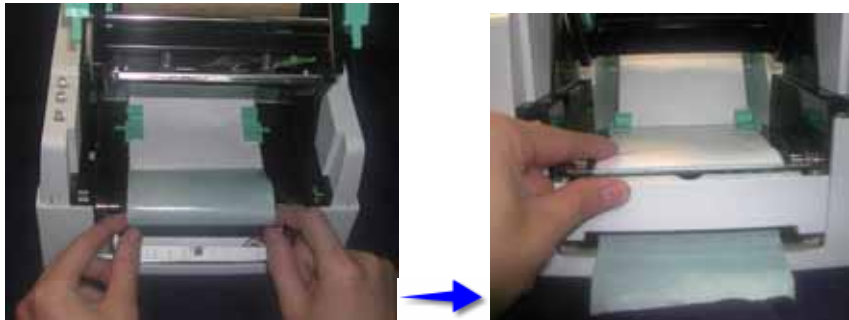

10. Close the print mechanism, then press the FEED key.



3-3. Stripper Installation Diagram

Stripper Installation Diagram

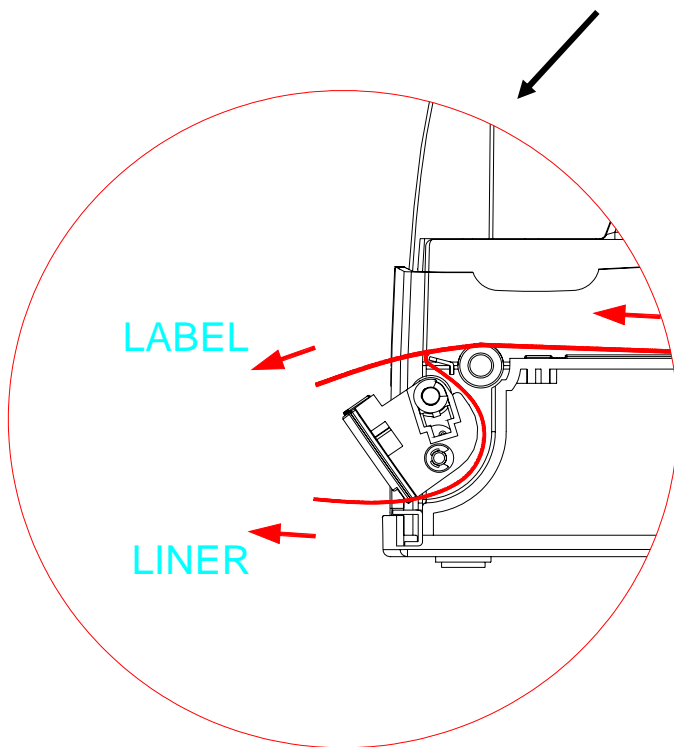
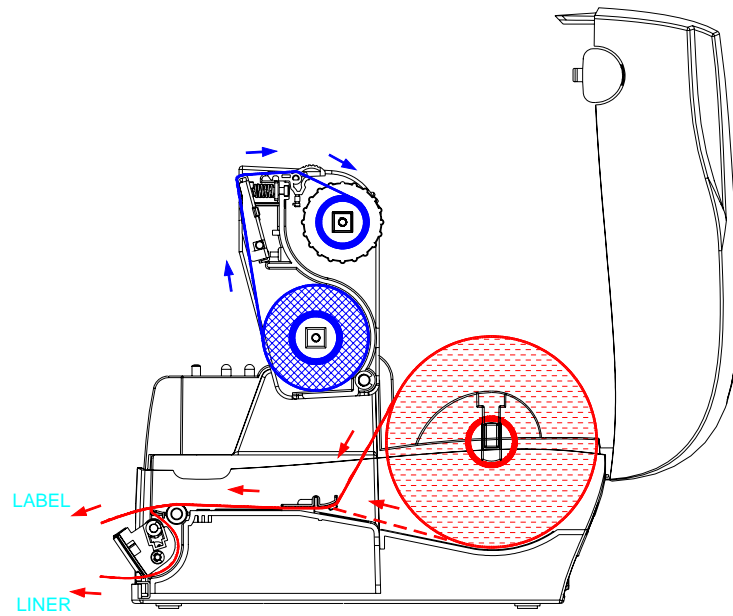

3-4. Cutter Parts

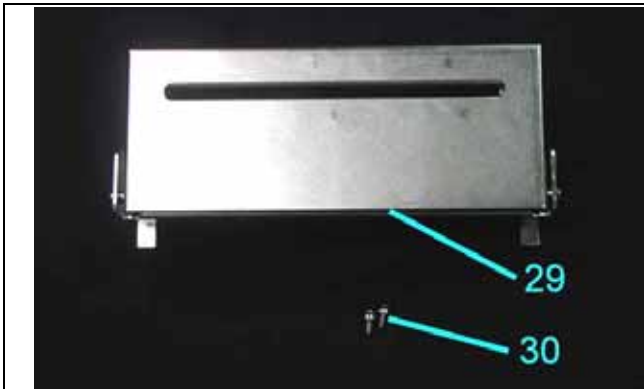

29	Cutter Module
30	Screw (TAP 3*8) x 2pcs

[Note1]: Please power off the printer before installing the cutter module.

[Note2]: Do not cut self-adhesive labels! The traces of adhesive will pollute the rotary knife and impair safe operation! The service life of the cutter is 500,000 cuts with 160g/m² paper weight and 250,000 cuts with 200g/m² paper weight.

[Note3]: Max.paper cutting width: 116mm

[Suggestion]: When installing the cutter module, set the stop position to 29 in QLabel. The E value is 29.

3-5. Cutter Installation

1. Open the top cover by pressing the Cover Open Buttons on both sides.



2. Push the front cover piece buttons inward to open.
3. Lift/take off the front cover piece according to the direction shown in the photo.

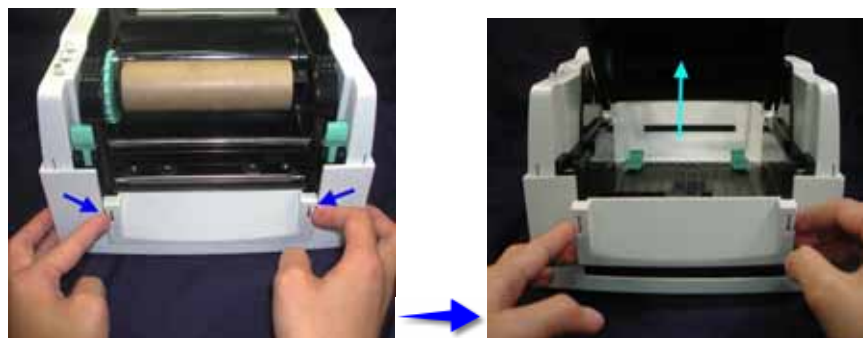

4. Open the mechanism by pressing the Locking Tenon, plug in the cable connector of the cutter module (29) onto the switchboard socket.

Note: There are 2 sockets on the converting boards (one is for stripper installation, another is for cutter installation), before plug the connector into socket, please check the pin first.

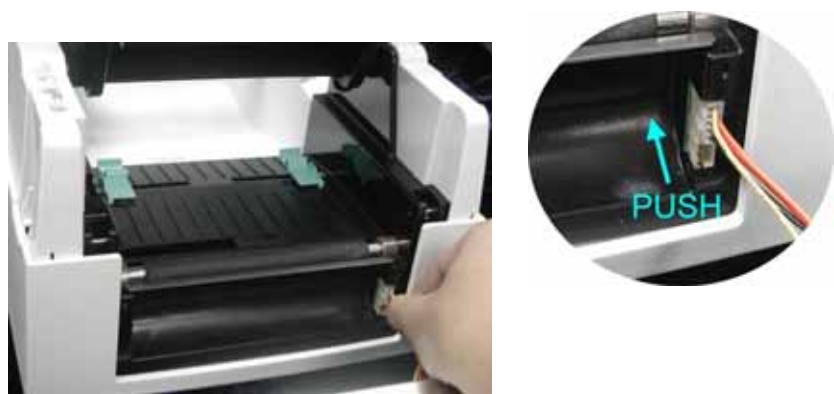

5. Clip in the right side of the cutter module (29) first, then secure the left side.

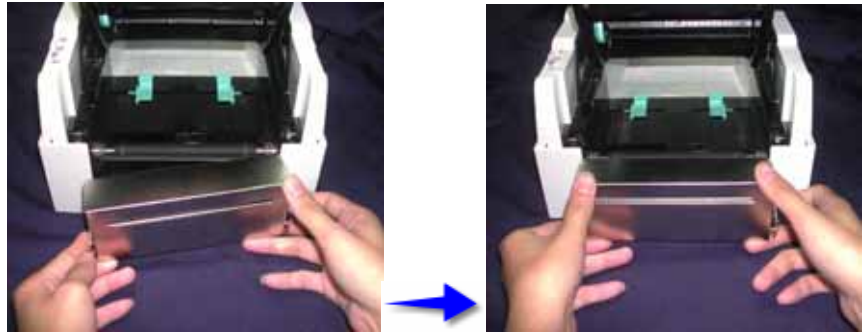

6. Flip the cutter module (29) down to open the cutter.

Note: Please refer to photo (A).

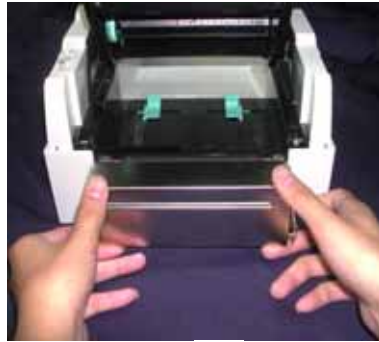

(A)

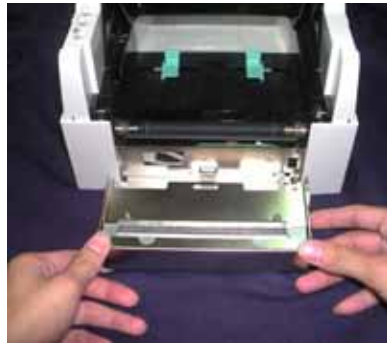

7. Hold the cutter module and lock it with the two side screws (30).



8. After the screws are locked, flip close the cutter module.

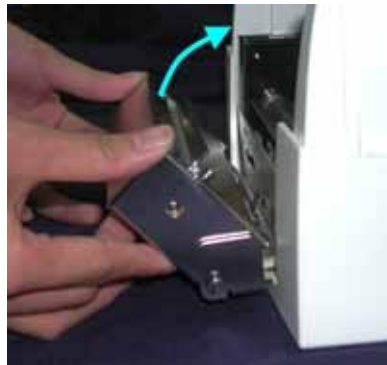

9. Close the mechanism to complete the cutter module installation.



3-6. Extended Memory Parts

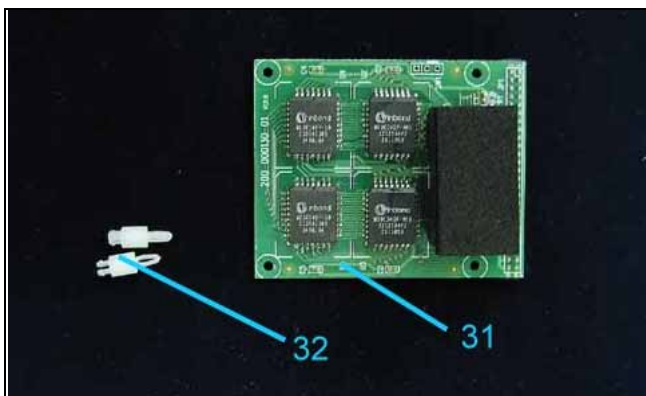

31	Extended Memory Card
32	PCB Pillar x 2pcs

[NOTE]: Please power off the printer before installing the extended memory.

3-7. Extended Memory Installation

1. Open the top cover by pressing the Cover Open Buttons on both sides.



2. Take off the media roll spindle. Open and remove the plastic cover on the inner base.



3. Secure the PCB pillar onto the main board.



4. Check the pins where the memory is to be connected to, then plug the memory card onto the main board.

Note: Please make sure the aperture on the connector and the pins match, otherwise when too much force is applied onto the memory card, there's a possibility that the pins may get damaged.

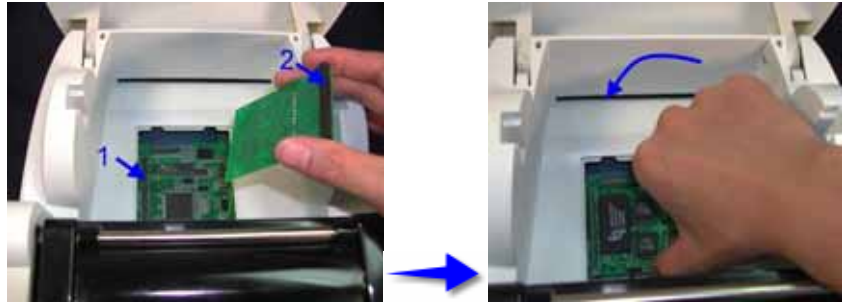

5. Close the plastic memory cover.



Chapter 4 - LED Message Description

4-1. LED Status

Press and hold the FEED key then power on the printer, the printer will beep 3 times and enter into Self-Test status. If keep holding the FEED key, the status will change in sequence to Auto Sensing Mode, Dump Mode, Direct Thermal Mode, Thermal Transfer Mode, See-through Sensor on/off, and then return to Self-Test again. These different statuses can change the setting of printer, they are described as follows:

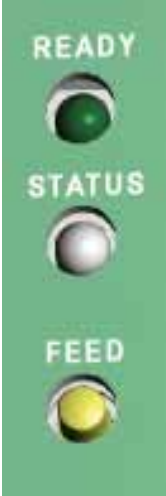
		FEED	LED Light	Beep	Status	Description	
	READY		Green	1	Normal status	Normal status	
	STATUS						
	Press and hold the FEED Key then power on the printer.						
	↓						
	READY		Red (Flash)	Orange	3	Self-Test	Printing Self-Test page, for operation instructions please refer to page 29.
	STATUS						
	↓						
	READY		Orange (Flash)	Orange	1	Auto Sensing Mode	Printers currently in Auto Sensing Mode, for operation instructions please refer to page 30.
	STATUS						
	↓						
READY		Green (Flash)	Orange	3	Dump Mode	Printers currently in Dump Mode, for operation instructions please refer to page 30 .	
STATUS							
↓							
READY		Red (Flash)	Red	1	Direct Thermal (DT) Mode	Set the printer to Direct Thermal (DT) Mode, for operation instructions please refer to page 30.	
STATUS							
↓							
READY		Orange (Flash)	Red	1	Thermal Transfer (TT) Mode	Set the printer to Thermal Transfer (TT) Mode, for operation instructions please refer to page 30.	
STATUS							
↓							
READY		Green (Flash)	Red	1	See-through Sensor on/off	Set the See-through Sensor on or off, for operation instructions please refer to page 31.	
STATUS							
↓							
Return to Self Test							
↓							
READY						Printer is currently downloading F/W	
STATUS		Red (Flash)					

4-2. Feed Key

After pressing the FEED key, printer will send the media (according to media type) to the specified stop position. When printing with continuous media, pressing the FEED key will feed media out to a certain length. When printing labels, pressing the FEED key will feed one label at a time; if the label is not sent out in a correct position, please proceed with the Auto Sensing (see page30).

4-3. Self-Test

The Self-Test function in a printer will help user to figure out whether the printer is operating normally. In the Self-Test Mode, the printer will print out a test sample each time when the FEED key is pressed. To break off the Self-Test procedure, just turn off the printer. Below are the Self-Test procedures:

1. Power off the printer, press and hold the FEED key.
2. Power on the printer (while still holding the FEED key); release the FEED key after printer beeping 3 times.
3. After about 1 second, printer would automatically print out the following. This indicates the printer is operating normally.

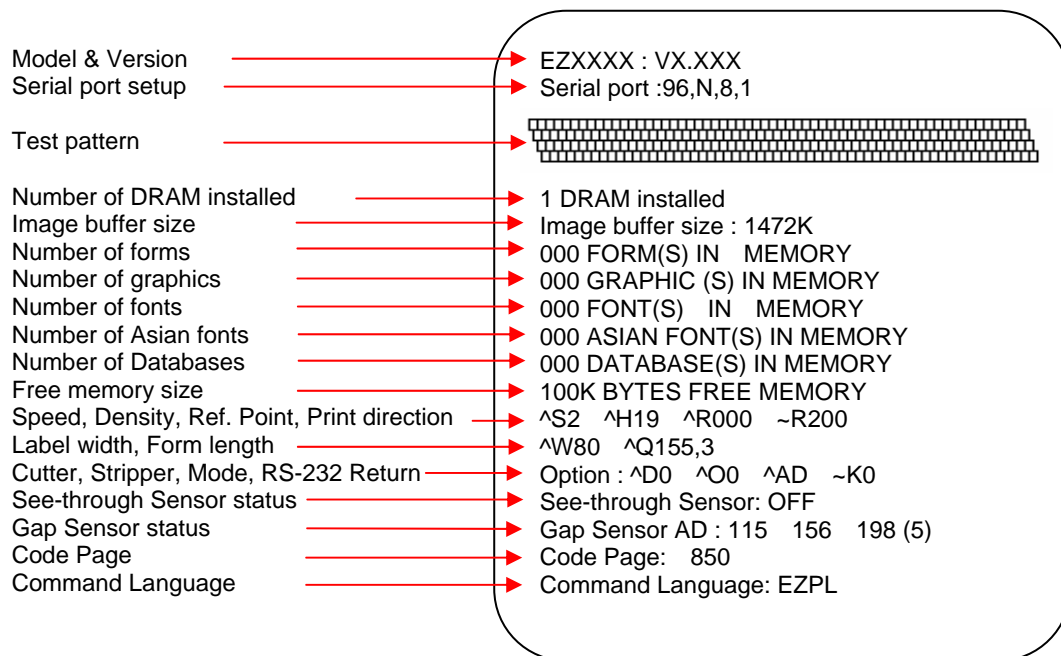

Self-Test includes the internal printer data setting.

4-4. Dump Mode

When label setting and the print result don't match, it's recommended to go into the Dump Mode to check whether there's a mistake in data transmission between the printer and the PC. For example, when printer receives 8 commands, yet without processing these commands, only print out the contents of the commands, this will confirm whether the commands were received correctly. Test procedures to enter the Dump Mode are as follows:

1. Power off the printer, press and hold the Feed key.
2. Press and hold the FEED button while power on the printer, after the printer makes 3 beeps, and the LED READY light flashes green and the LED STATUS light turns orange, the printer goes into the Dump Mode. Then release the FEED button. The printer will automatically print out "DUMP MODE BEGIN". This indicates that the printer is currently in Dump Mode.
3. Printer will automatically print "DUMP MODE BEGIN." This means the printer is already in Dump Mode.
4. Send commands to the printer, and check to see if the print result matches the commands sent.
5. Press the Feed key to exit the Dump Mode, now the printer will automatically print "OUT OF DUMP MODE." This means the printer is back in the normal status.

Note: To cancel (get out of the Dump Mode), press the Feed key, this time printer will automatically print out "OUT OF DUMP MODE." This indicates that printer is back in the standby mode. Or power off to exit the Dump Mode.

4-5. Auto Sensing

Printer can automatically detect label (black mark paper) length and record. This way, without setting the print length, the printer can accurately detect the label (black mark) positions.

1. Check if the Moveable Sensor Mark is located at the right sensing position.
2. Power off the printer, press and hold the Feed key.
3. Press and hold the FEED button while power on the printer, after the printer makes 3 beeps, and wait until the LED READY light flashes orange and the LED STATUS light turns orange, the printer will go into the Auto Sensing Mode. Then release the FEED button. The printer will automatically record the label size.

4-6. Direct Thermal / Thermal Transfer Mode Switch

1. Power off the printer, press and hold the Feed key.
2. Press and hold the FEED button while power on the printer, after the printer makes 3 beeps, and wait until the LED READY light flashes red and the LED STATUS light turns red, the printer will go into Direct Thermal (DT) Mode. Then release the FEED button. The printers will automatically print "NOW IS DIRECT THERMAL (DT MODE)". This indicates that printer is currently in DT Mode.
3. Press and hold the FEED button while power on the printer, after the printer makes 3 beeps, and wait until the LED READY light flashes orange and the LED STATUS light turns red, the printer will go into the Thermal Transfer (TT) Mode. Then release the FEED button. The printers will automatically print "NOW IS THERMAL TRANSFER (TT MODE)". This indicates that printer is currently in TT Mode.

NOW IS THERMAL TRANSFER (TT MODE)

NOW IS DIRECT THERMAL (DT MODE)

4-7. See-through Sensor on/off

There are two types of sensor in EZ-1000 series printer - Reflective Sensor and See-through Sensor. Users can set one of them as active sensor. By default, the Reflective Sensor is turned on and the See-through Sensor is turned off. To turn the See-through Sensor on, please do as follows:

1. Power off the printer, press and hold the FEED key.
2. Power on the printer (while still holding the FEED key) and the printer will beep 3 times. Keep holding the FEED key, wait for the STATUS light turn red and READY light flash green, then release the FEED key. The printers will automatically print "SEE-THROUGH SENSOR IS ON". This indicates that the See-Through Sensor is turned on (and the Reflective Sensor is turned off).
3. To turn off the See-Through Sensor, please repeat above-mentioned procedures. Then the printer will print "SEE-THROUGH SENSOR IS OFF" to indicate that the See-Through Sensor is turned off.

SEE-THROUGH SENSOR IS ON
or
SEE-THROUGH SENSOR IS OFF

For checking the status of See-through Sensor (on or off), please perform Auto Sensing once. If both of READY and STATUS lights are green when doing Auto Sensing, then the See-through Sensor is on. If both of READY and STATUS lights are orange, then the See-through Sensor is off.

【Note】

When the See-through Sensor is enabled, the moveable sensor must be placed in the center of the printer.

4-8. Error Messages

LED Message	LED Light		Beep	Description	Solution
	Ready	Status			
Print head is opened		Red	4 beeps twice	Print head not firmly in place.	Re-open print head and make sure it closes tightly.
Entering the Cooling Process		Red (Flash)	None	Print head temperature high.	When print head temperature drops to the normal temperature range, printer will go back to the standby mode.
Out of ribbon or check ribbon sensor		Red	3 beeps twice	Ribbon not installed, and printer shows error message.	Make sure the printer is in the Direct Thermal mode.
				Ribbon used up or ribbon supply shaft not moving.	Replace with new ribbon roll.
Out of media or check media gap sensor		Red	2 beeps twice	Unable to detect paper.	Make sure the movable sensor mark is at the correct position, if the sensor is still unable to detect paper, and then go through Auto Sensing again.
				Paper used up.	Replace with new label roll.
Check paper setting		Red	2 beeps twice	Abnormal paper feed.	Possible causes: card tags or paper fall into the gap behind the platen roller, can't find label gap/black mark, black mark paper out. Please adjust according to actual usage.
Command is not recognized		Red	2 beeps twice	Wrong command; printer will print out "Command is not recognized."	Check printer commands, possible value missing or errors.
Memory is full		Red	2 beeps twice	Memory is full; printer will print out "Memory full."	Delete unnecessary data in the memory or purchase extended memory (options).
Filename can not be found		Red	2 beeps twice	Can't find the file; printer will print out "Filename can not be found."	Use "~X4" command to print out all the files, then check whether the file exist and the names are correct.
Filename is repeated		Red	2 beeps twice	File name is repeated; printer will print out "Filename is repeated."	Change the file name and download again.

Chapter 5 - Maintenance and Adjustment

5-1. Thermal Print Head Cleaning

Unclear printouts (some parts unable to print) may be caused by dusty print head, ribbon stain, or label liner glue, therefore when printing, it's necessary to keep the top cover closed. Also, check and prevent paper/label from being stained or dusty to ensure print quality and to prolong the print head life. Print head cleaning instructions are as follows:

1. Power-off the printer.
2. Open top cover.
3. Take out the ribbon.
4. Open the print head by pressing the locking tenons.
5. If on the print head (see yellow arrow) there's label pieces or other stain, please use a soft cloth with industrial use alcohol to wipe away the stain.

Note:

- (1) *Weekly cleaning on the print head is recommended.*
- (2) *Please clean the print head with the cleaning card that comes with the printer.*

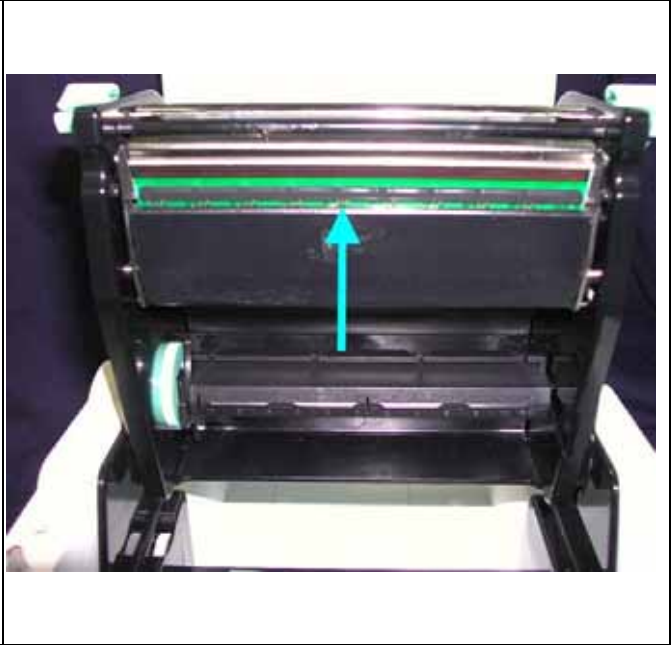

5-2. Thermal Print Head Balance Adjustment

When printing with different label materials or using different ribbon types, unbalanced print quality may occur due to the media material differences, thus it's necessary to adjust the Thermal Print Head pressure.

1. Open top cover.
2. Take out the ribbon.
3. Turning the print head adjustment screws slightly by Philips screwdriver to increase or decrease print head pressure.



5-3. Print Line Adjustment

Use print head adjusting gear to adjust the contacting surface between print head and label. To get better printing balance and quality.

1. When turning print head adjusting gear counter-clockwise (as arrow 1 shows), print head would move in a direction where arrow A is.
2. When turning print head adjusting gear clockwise (as arrow 2 shows), print head would move in a direction where arrow B is.

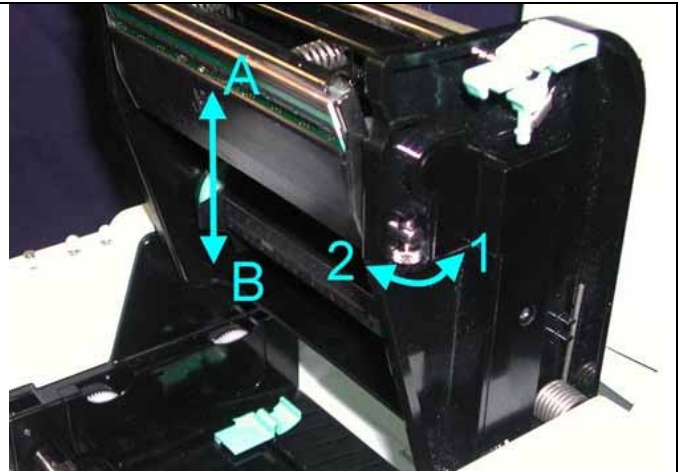

5-4. Adjust the cutter

1. A cutter-adjusting hole is present on both sides (where A is pointing to).
2. The cutter will not function properly if there is a paper jam. Turn the power off and use a #M3 hexagon wrench inserted into hole "A" and open the cutter from right to left.
3. Power on the printer after clearing the paper jam, the cutter will return to the correct position automatically.

Note: The label / paper used for cutting is suggested to be at least 30mm in height.

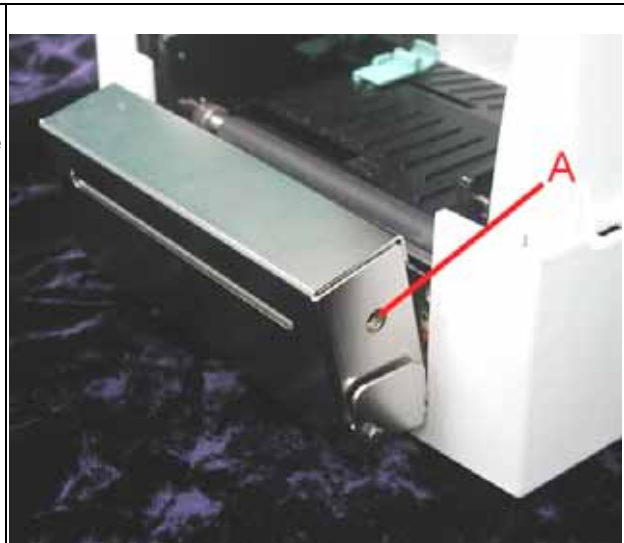

5-5. Troubleshooting

Problem	Recommended Solution
Power on the printer, but the LED does not light up	<ul style="list-style-type: none"> ◆ Check the power connector
LED light turns red (power/status) after printing stops	<ul style="list-style-type: none"> ◆ Check for software setting or program command errors ◆ Replace with suitable label or ribbon ◆ Check if label or ribbon is all out ◆ Check if label is jammed/tangled up ◆ Check if mechanism is closed (Thermal Print Head not positioned correctly) ◆ Check if sensor is blocked by paper/label ◆ Check for abnormal cutter function or of no actions (if cutter is installed)
Printing started, but nothing was printed on the label	<ul style="list-style-type: none"> ◆ Check if label is placed upside down or if label is not suitable for the application ◆ Select the correct printer driver ◆ Select the correct label and print type
When printing, label is jammed/tangled up	<ul style="list-style-type: none"> ◆ Clean the label jam, and if label is stuck on Thermal Print Head, please remove it by using soft cloth with alcohol.
When printing, only part of the contents were printed	<ul style="list-style-type: none"> ◆ Check if label or ribbon is stuck on the Thermal Print Head ◆ Check if application software has errors ◆ Check if start position setting has errors ◆ Check if ribbon has wrinkles ◆ Check if ribbon supply shaft is creating friction with the platen roller. If the platen roller needs to be replaced, please contact your reseller for more information ◆ Check if power supply is correct
When printing, part of the label wasn't printed completely	<ul style="list-style-type: none"> ◆ Check if Thermal Print Head is stained or dusted ◆ Use internal command "~T" to check Thermal Print Head can print completely ◆ Check the media quality
Printout not in desired position	<ul style="list-style-type: none"> ◆ Check if sensor is covered by paper or dust ◆ Check if liner is suitable for use, please contact reseller for more information ◆ Check if label roll edge is aligned with Label Width Guide
When printing, page skipping occurs	<ul style="list-style-type: none"> ◆ Check if error occurs on label height setting ◆ Check is sensor is covered by dust
Unclear printout	<ul style="list-style-type: none"> ◆ Check print darkness setting ◆ Check if Thermal Print Head is covered with glue or stain
When using cutter, label wasn't cut straight	<ul style="list-style-type: none"> ◆ Check if label is set up straight
When using cutter, label wasn't cut successfully	<ul style="list-style-type: none"> ◆ Check whether label thickness exceeds 0.2mm
When using cutter, label couldn't feed or abnormal cutting occurs	<ul style="list-style-type: none"> ◆ Check if cutter is installed properly ◆ Check if Paper Feed Rods are sticky
When using stripper, abnormal function occurs	<ul style="list-style-type: none"> ◆ Check if stripper sensor is covered with dust ◆ Check if label is installed properly

Note: If further problems shall occur, please contact your distributor for more information.