

CipherLab Reference Manual

1800 Series Handheld RFID Reader

For CP Series/8 Series/Universal

Version 1.06



Copyright © 2012~2016 CIPHERLAB CO., LTD.
All rights reserved

The software contains proprietary information of CIPHERLAB CO., LTD.; it is provided under a license agreement containing restrictions on use and disclosure and is also protected by copyright law. Reverse engineering of the software is prohibited.

Due to continued product development this information may change without notice. The information and intellectual property contained herein is confidential between CIPHERLAB and the client and remains the exclusive property of CIPHERLAB CO., LTD. If you find any problems in the documentation, please report them to us in writing. CIPHERLAB does not warrant that this document is error-free.

No part of this publication may be reproduced, stored in a retrieval system, or transmitted in any form or by any means, electronic, mechanical, photocopying, recording or otherwise without the prior written permission of CIPHERLAB CO., LTD.

For product consultancy and technical support, please contact your local sales representative. Also, you may visit our web site for more information.

The CipherLab logo is a registered trademark of CIPHERLAB CO., LTD.

All brand, product and service, and trademark names are the property of their registered owners.

The editorial use of these names is for identification as well as to the benefit of the owners, with no intention of infringement.

CIPHERLAB CO., LTD.

Website: <http://www.cipherlab.com>

IMPORTANT NOTICES

FOR USA

This equipment has been tested and found to comply with the limits for a **Class B** digital device, pursuant to Part 15 of the FCC Rules. These limits are designed to provide reasonable protection against harmful interference in a residential installation. This equipment generates, uses and can radiate radio frequency energy and, if not installed and used in accordance with the instructions, may cause harmful interference to radio communications. However, there is no guarantee that interference will not occur in a particular installation. If this equipment does cause harmful interference to radio or television reception, which can be determined by turning the equipment off and on, the user is encouraged to try to correct the interference by one or more of the following measures:

- ▶ Reorient or relocate the receiving antenna.
- ▶ Increase the separation between the equipment and receiver.
- ▶ Connect the equipment into an outlet on a circuit different from that to which the receiver is connected.
- ▶ Consult the dealer or an experienced radio/TV technician for help.

This device complies with Part 15 of the FCC Rules. Operation is subject to the following two conditions: (1) This device may not cause harmful interference, and (2) this device must accept any interference received, including interference that may cause undesired operation.

FCC Caution: Any changes or modifications not expressly approved by the party responsible for compliance could void the user's authority to operate this equipment.

This transmitter must not be co-located or operating in conjunction with any other antenna or transmitter.

Radiation Exposure Statement:

This equipment complies with FCC radiation exposure limits set forth for an uncontrolled environment. This equipment should be installed and operated with minimum distance 20cm between the radiator & your body.

FOR EUROPE

This device complies with the essential requirements of the R&TTE Directive 1999/5/EC. The following test methods have been applied in order to prove presumption of conformity with the essential requirements of the R&TTE Directive 1999/5/EC:

- ▶ - EN 60950-1: 2006+A11:2009

Safety of Information Technology Equipment

- ▶ - EN 301 908-1 V4.2.1: 2010

Electromagnetic compatibility and Radio spectrum Matters (ERM); Base Stations (BS), Repeaters and User Equipment (UE) for IMT-2000 Third-Generation cellular networks; Part 1: Harmonized EN for IMT-2000, introduction and common requirements, covering essential requirements of article 3.2 of the R&TTE Directive

- ▶ - EN 301 908-1 V5.2.1: 2011

Electromagnetic compatibility and Radio spectrum Matters (ERM); Base Stations (BS), Repeaters and User Equipment (UE) for IMT-2000 Third-Generation cellular networks; Part 1: Harmonized EN for IMT-2000, introduction and common requirements, covering essential requirements of article 3.2 of the R&TTE Directive

- ▶ - EN 301 489-1 V1.8.1: 2008

Electromagnetic compatibility and Radio Spectrum Matters (ERM); ElectroMagnetic Compatibility (EMC) standard for radio equipment and services; Part 1: Common technical requirements

- ▶ - EN 301 489-3 V1.4.1 2002

Electromagnetic compatibility and Radio Spectrum Matters (ERM); ElectroMagnetic Compatibility (EMC) standard for radio equipment and services; Part 3: Specific conditions for Short-Range Devices (SRD) operating on frequencies between 9 kHz and 40 GHz

- ▶ - EN 301 489-17 V2.1.1 2009

Electromagnetic compatibility and Radio spectrum Matters (ERM); ElectroMagnetic Compatibility (EMC) standard for radio equipment and services; Part 17: Specific conditions for 2,4 GHz wideband transmission systems and 5 GHz high performance RLAN equipment

- ▶ - EN 300 328 V1.7.1: 2006

Electromagnetic compatibility and Radio spectrum Matters (ERM); Wideband Transmission systems; Data transmission equipment operating in the 2,4 GHz ISM band and using spread spectrum modulation techniques; Harmonized EN covering essential requirements under article 3.2 of the R&TTE Directive

- ▶ - EN 302 208-1 V1.4.1: 2011

Electromagnetic compatibility and Radio spectrum Matters (ERM); Radio Frequency Identification Equipment operating in the band 865 MHz to 868 MHz with power levels up to 2 W; Part 1: Technical requirements and methods of measurement

- ▶ - EN 302 208-2 V1.3.1: 2010

Electromagnetic compatibility and Radio spectrum Matters (ERM); Radio Frequency Identification Equipment operating in the band 865 MHz to 868 MHz with power levels up to 2 W; Part 2: Harmonized EN covering essential requirements of article 3.2 of the R&TTE Directive

- ▶ - EN50371 : 2002

Generic standard to demonstrate the compliance of low power electronic and electrical apparatus with the basic restrictions related to human exposure to electromagnetic fields (10 MHz - 300 GHz) -- General public

SAFETY PRECAUTIONS

RISK OF EXPLOSION IF BATTERY IS REPLACED BY AN INCORRECT TYPE. DISPOSE OF USED BATTERIES ACCORDING TO THE INSTRUCTIONS.

- ▶ The use of any battery or charging devices, which are not originally sold or manufactured by CipherLab, will void your warranty and may cause damage to human body or the product itself.
- ▶ DO NOT disassemble, incinerate or short circuit the battery.
- ▶ DO NOT expose the reader or the battery to any flammable sources.
- ▶ For green-environment issue, it's important that battery should be recycled in a proper way.
- ▶ Under no circumstances, internal components are self-serviceable.
- ▶ The charging uses an AC power adapter. A socket outlet shall be installed near the equipment and shall be easily accessible. Make sure there is stable power supply for the reader or its peripherals to operate properly.

CARE & MAINTENANCE

- ▶ This reader is intended for industrial use. The reader is rated IP64, however, it may do damage to the reader when being exposed to extreme temperatures or soaked wet.
- ▶ DO NOT use any pointed or sharp object to move any cover that is included on the reader.
- ▶ If you want to put away the reader for a period of time, download the collected data to a host computer, and then take out the battery pack. Store the reader and battery pack separately.
- ▶ When the reader resumes its work, the battery will take a certain time to become fully charged.
- ▶ If you shall find the reader malfunctioning, write down the specific scenario and consult your local sales representative.

RELEASE NOTES

Version	Date	Notes
1.06	Feb. 15, 2016	<ul style="list-style-type: none">▶ Modified: descriptions relating to CD-ROM removed▶ Modified: 2.5.1 – index 15 added for #@bt_hididx▶ Modified: 4.2.2 – 10ms for scan delay time appended
1.05	Mar. 04, 2015	<ul style="list-style-type: none">▶ Modified: 1.4.1 – description for LED1-Power revised (Red On))▶ Modified: 3.1.2 – #@bt_recon of ASCII command added▶ Modified: 4.2.2 – parameters for scan delay time revised
1.04	Nov. 19, 2014	<ul style="list-style-type: none">▶ Modified: 1.5 – Command Beep is disabled by default▶ Modified: 4.3.3 – #@rf_sepc1 corrected to #@rf_sepcl (example code)▶ Modified: 4.6.1 – default Q value for 1862 added▶ Modified: 4.6.2 – default Output Power level for 1862 added▶ Modified: 5.2.3 EPC Tag Section – descriptions for “#@dat_rfspr=” added▶ Modified: Specifications – 1862 added▶ Modification: Appendix IV Status Code – code table updated
1.03	Oct. 07, 2013	<ul style="list-style-type: none">▶ Modification: 1.1.4 Low Battery Alarm – Charging status definition added to SYS_BATTERY command▶ Modification: 1.8 Event events sent via USB & bit 9 definition added to SYS_EVT command▶ Modification: Appendix IV Status Code – code table updated
1.02	May. 27, 2013	<ul style="list-style-type: none">▶ Modification: 1.2.1 Transmit Buffer – Transmission Buffer commands revised/added (SYS_TXBEN, SYS_TXBUP, SYS_TXBCLR)▶ Modification: 1.2.2 Memory Mode - SYS_MEMUP command revised▶ New: 1.8 Event added (SYS_EVT command)▶ Modification: 4.5.2 Read/Write Tag – “RF_RWIDX” memory bank value revised▶ New: 4.6.1 Applications in Multiple Tags Environment – RF_Q command added▶ New: 4.6.2 Adjustment for Output Power Level of the Reader – RF_PLV command added▶ New: 5.4 Output EPC Data via USB Virtual COM DAT_2USB command added▶ Modification: Ch. 6 Alternate Mode - #@dat_ostr=1,#@iOSKBD command added
1.01	Dec. 17, 2012	Revised according TC manual
1.00	Sep. 18, 2012	Initial Release

CONTENTS

- IMPORTANT NOTICES.....- 3 -**
 - For USA - 3 -
 - For Europe - 4 -
 - Safety Precautions - 6 -
 - Care & Maintenance - 6 -
- RELEASE NOTES- 7 -**
- INTRODUCTION 1**
 - Getting Familiar with RFID Reader 2
 - Overview 2
 - Installing the Battery 3
 - Charging the Battery 4
 - Charging the Battery via Charger 5
 - Inside the Package 6
 - Features 6
 - Accessories 6
- QUICK START 7**
 - Power on RFID Reader 7
 - Connecting USB Cable 7
 - Issuing Commands via USB Connection 8
 - Using HyperTerminal 8
 - Confirming the USB Connection 12
 - Default Settings 14
 - Save User Settings as Defaults 14
 - Restore User/Factory Defaults 14
 - Reader Switch 15
 - Combining with a Mobile Computer 16
 - 1800 Configuration 17
- UNDERSTANDING RFID READER 19**
 - 1.1 Power 21
 - 1.1.1 Power ON 21
 - 1.1.2 Power OFF 21
 - 1.1.3 Power Saving Mode 22
 - 1.1.4 Low Battery Alarm 23
 - 1.2 Memory 24
 - 1.2.1 Transmit Buffer 24
 - 1.2.2 Memory Mode 27
 - 1.3 Function Keys 31
 - 1.3.1 RFID Mode 32
 - 1.3.2 *Bluetooth*[®] Pairing Mode 35

1.3.3 Alternate Mode.....	36
1.4 LED Indicators.....	37
1.4.1 General Mode.....	37
1.4.2 Function Key Mode	39
1.4.3 <i>Bluetooth</i> ® Pairing Mode	39
1.5 Beeper.....	40
1.6 Vibrator.....	44
1.7 RTC	45
1.8 Event.....	46
COMMUNICATION INTERFACE	47
2.1 USB Interface	48
2.2 <i>Bluetooth</i> ® Connection Type.....	49
2.3 <i>Bluetooth</i> ® SPP Slave.....	50
2.4 <i>Bluetooth</i> ® SPP Master	51
2.4.1 Activate <i>Bluetooth</i> ® SPP Master Mode.....	51
2.5 <i>Bluetooth</i> ® HID.....	52
2.5.1 Activate <i>Bluetooth</i> ® HID & Select Keyboard Type	52
2.5.2 Keyboard Settings.....	55
2.5.3 Inter-Character Delay	60
2.5.4 Inter-Function Delay.....	60
2.5.5 HID Character Transmit Mode.....	60
2.6 USB VCOM and HID via 3610	61
2.6.1 Activate USB VCOM and HID & Select Keyboard Type.....	62
2.6.2 HID Keyboard Settings.....	65
2.6.3 Inter-Character Delay	70
2.6.4 Inter-Function Delay.....	70
2.6.5 HID Character Transmit Mode.....	70
SETTING UP A WPAN CONNECTION	71
3.1 Connecting via <i>Bluetooth</i> ® Dongle	72
3.1.1 Change Interface.....	72
3.1.2 Configure Related Settings.....	73
3.1.3 <i>Bluetooth</i> ® HID and SPP Slave.....	77
3.1.4 <i>Bluetooth</i> ® SPP Master.....	85
3.2 Connecting via 3610	89
3.2.1 Connect to 3610	89
3.2.2 USB HID via 3610 Connection	89
3.2.3 USB VCOM via 3610 Connection	91
3.3 Disconnection	92
3.3.1 Break a Connection.....	92
3.3.2 Reset a Connection.....	92
SCANNING UHF RFID TAG.....	93
4.1 Scan Mode	94
4.2 Scan Time	96
4.2.1 Timeout.....	96
4.2.2 Delay Time	97
4.3 Filter.....	98

4.3.1 EPC Encoding Scheme.....	99
4.3.2 Affected Tag of Included/Excluded EPC Filter.....	101
4.3.3 Included EPC	102
4.3.4 Excluded EPC.....	106
4.4 Multi-Tag.....	110
4.4.1 Counter	110
4.4.2 Counter Reload	112
4.4.3 Multi-Tag Beep	113
4.5 Access Tag	114
4.5.1 Tag Memory.....	114
4.5.2 Read/Write Tag.....	116
4.6 Advanced Settings.....	121
4.6.1 Applications in Multiple Tags Environment	121
4.6.2 Adjustment for Output Power Level of The Reader.....	122
DEFINING OUTPUT FORMAT	123
5.1 Output Format.....	124
5.2 Format Editing for Hexadecimal and Raw Data.....	126
5.2.1 Data Counter Section.....	128
5.2.2 Time stamp Section	131
5.2.3 EPC Tag Section	137
5.3 Prefix/Suffix Code.....	142
5.4 Output EPC Data via USB Virtual COM	145
ALTERNATE MODE	147
SPECIFICATIONS	151
System	151
Communications	151
Reader.....	151
Electrical Characteristics	152
Physical Characteristics.....	152
Environmental Characteristics	153
Programming Support.....	153
Accessories.....	153
FIRMWARE UPGRADE	155
Before Upgrading	155
How to Upgrade Firmware	156
Use USB Virtual COM	156
Use <i>Bluetooth</i> ® Dongle	157
Use 3610.....	157
Use <F2>+<Trigger>.....	157

ASCII TABLE 159

SCAN CODE..... 161

STATUS CODE 163

INTRODUCTION

1800 Series RFID Reader is designed to be the most flexible and reliable rugged RFID gun with ergonomic form factor on the market. In terms of hardware specifically designed to work as lightweight, ergonomic design, user-friendly LED display, easy snap-on structure, storage capability and aggressive read-and-write range, 1800 Series RFID Reader provides an efficient and complete solution for various applications when combined with mobile computers using custom mount.

The Reader is easily integrated with mobile computers through *Bluetooth*[®] and with host PC through USB. For the environment, 1800 Series RFID Reader is also equipped with IP64 and 1.5m drop resistance features.

This manual serves to guide you through how to install, configure, and operate 1800 Series RFID Reader. We recommend you keep one copy of the manual at hand for quick reference or maintenance purposes. To avoid any improper disposal or operation, please read the manual thoroughly before use.

Refer to the following documents to get more information about UHF RFID and EPC standards.

- ▶ *EPC[™] Radio-Frequency Identity Protocols Class-1 Generation-2 UHF RFID Protocol for Communications at 860 MHz-960MHz Version1.2.0*
- ▶ *EPC[™] Tag Data Standards Version1.6 (September 9, 2011)*





They are available through GS1 organization, <http://www.gs1.org>.

Thank you for choosing CipherLab products!

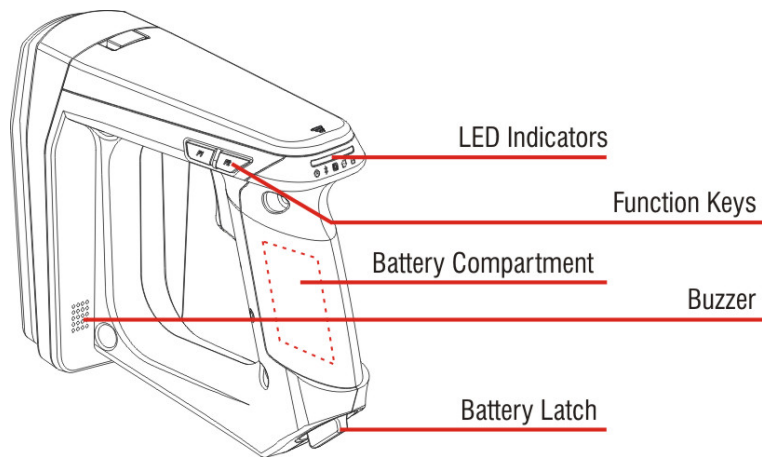
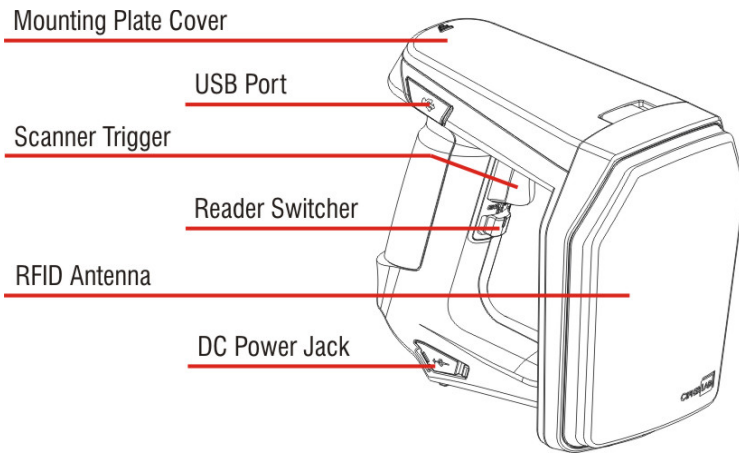
GETTING FAMILIAR WITH RFID READER

OVERVIEW



LED	Icon	Function
1		Power
2		Bluetooth® Communication
3		RFID Tag Access
4		Data Transmission
5		Reader Indicator/Memory Low

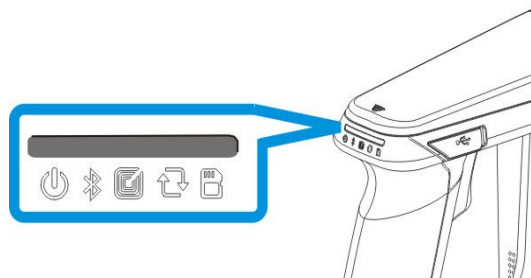

INSTALLING THE BATTERY

- 1) This RFID Reader is powered by a rechargeable 2500 mAh Li-ion battery. For intensive data collection, we suggest it is better to purchase a spare battery for non-stop operation.
- 2) Turn the battery latch to unlock position.
- 3) Remove the battery cover.
- 4) Insert the battery into the battery compartment so that the metal contacts on the battery meet with the charging contacts inside the compartment. Make sure that the battery fits snugly into the compartment.
- 5) Replace and turn the battery cover until it locks into place.
- 6) After the battery is charged successfully, press the trigger to power on the RFID Reader. If you cannot power on the RFID Reader, please check that the battery is charged and that it has been inserted correctly.

Note: (1) Any improper handling may reduce the battery life.

(2) When the main battery capacity becomes low, you need to charge the battery as soon as possible or replace it with a charged one. Before replacing the battery, make sure the power is turned off.

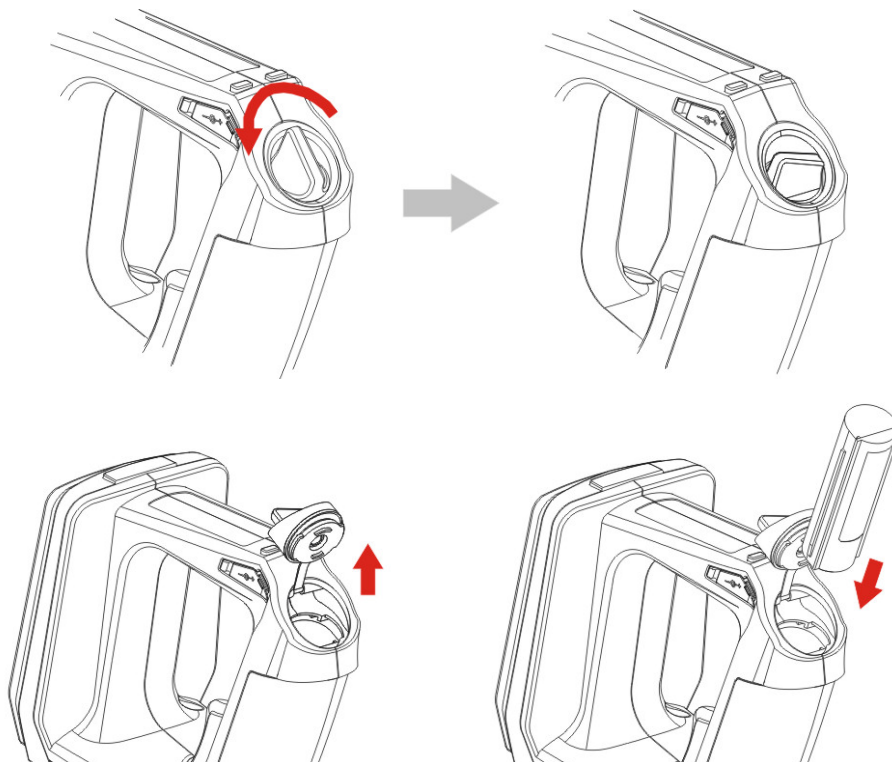

CHARGING THE BATTERY

New batteries are not fully charged. When you first receive the package, you will need to charge the battery to full before using the RFID Reader. For RFID Reader, use the adapter to charge the battery. It takes approximately 4 hours to charge the battery to full.

- 1) Install the battery in RFID Reader.
- 2) Remove the cover to the power jack.
- 3) Connect the power cord to the power jack.
- 4) Connect the other end of the power cord to a suitable power outlet.
- 5) The RFID Reader LED1 will be flashing red during charging. When the charging is done, the LED1 will flash green. If charging error occurs, the LED1 will turn solid red. For example, a bad or missing battery.

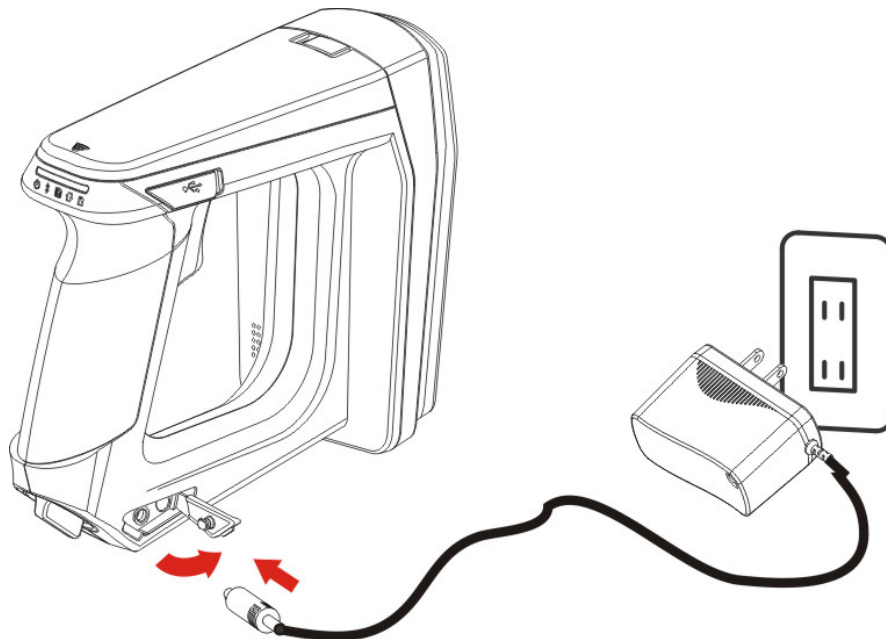

Note: Battery charging stops when the temperature drops below 0°C or exceeds 40°C. It is recommended to charge the battery at room temperature (18°C to 25°C) for optimal performance.

CHARGING THE BATTERY VIA CHARGER

Batteries may also be charged through the battery charger rather than in the reader itself, allowing the user to continue using the reader at all times.

- 1) Connect the power supply cord to the power port located on the back of the charger.
- 2) Insert the battery to the end.
- 3) Confirm the lock bolt locks the battery securely.
- 4) Connect the other end of the power cord to a suitable power outlet.
- 5) Once the power and battery are ready, the LED indicator lights.
- 6) After finishing charge, press down the lock bolt to pull out the battery.

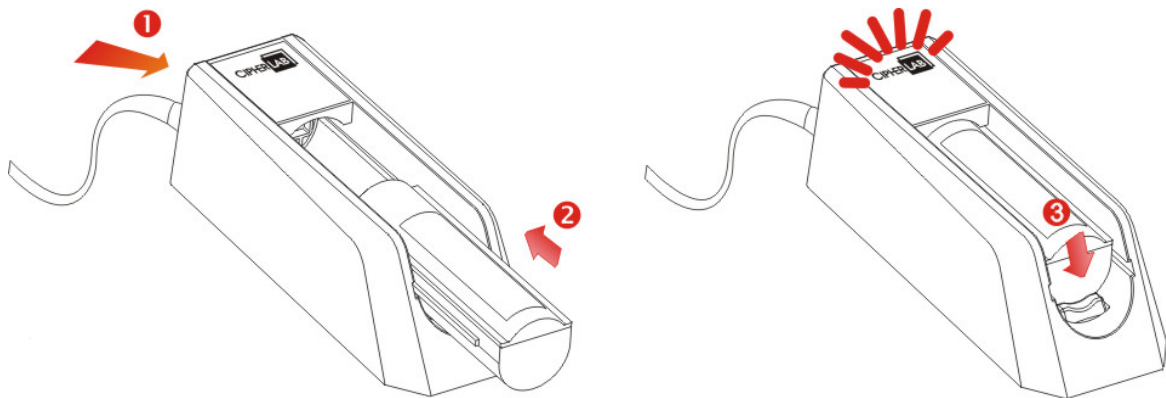

Status LED	Function
Blue, Solid	Charger power ON
Red, Solid	Charging battery
Green, Solid	Charging done
Blue/Red Ratio 0.5s:0.5s	Error

Note: Battery charging stops when the temperature drops below 0°C or exceeds 40°C. It is recommended to charge the battery at room temperature (18°C to 25°C) for optimal performance.

INSIDE THE PACKAGE

The following items are included in the package. Save the box and packaging material for future use in case you need to store or ship device.

- ▶ 1800 Series Handheld RFID Reader
- ▶ Rechargeable Li-ion Battery
- ▶ Direct USB Cable
- ▶ Power Adapter
- ▶ Quick Guide
- ▶ Test Tags

FEATURES

- ▶ Ergonomic design - ruggedized yet streamlined
- ▶ Built tough to survive multiple drops and sealed against moisture/dust to industrial standard IP64
- ▶ CipherLab Proprietary operating system
- ▶ 4MB flash for Memory Mode operation
- ▶ Provides up to 2KB SRAM for reserve buffer while getting out of range over a wireless personal area network (WPAN)
- ▶ UHF RFID Reader (ISO-18000-6C/EPC Class1 Gen2 Standard)
- ▶ Ambidextrous friendly Trigger
- ▶ Connectivity includes *Bluetooth*[®] and USB
- ▶ Programmable feedback including beeper and vibrator
- ▶ Support user-friendly LED1~5 display with 3 colors
- ▶ Up to 100cm reading performance and 50cm writing ability.
- ▶ Programming support includes System and .NET API, 8/9 and CP Series (LIB and DLL)
- ▶ Accessory for single-split-type battery charger

ACCESSORIES

Rich choices of optional accessories are available for you to enhance the total performance of the RFID Reader.

- ▶ Spare Rechargeable Li-ion Battery
- ▶ External Battery Charger
- ▶ Direct USB Cable
- ▶ Power Cable
- ▶ Mobile Computer Mount

QUICK START

POWER ON RFID READER

Be sure the battery is fully charged before you power on the RFID Reader. Press the trigger for 2 seconds to power on the RFID Reader. The reader will respond with a long beep (high tone), and LED1 will become solid red for 1 second and go off.

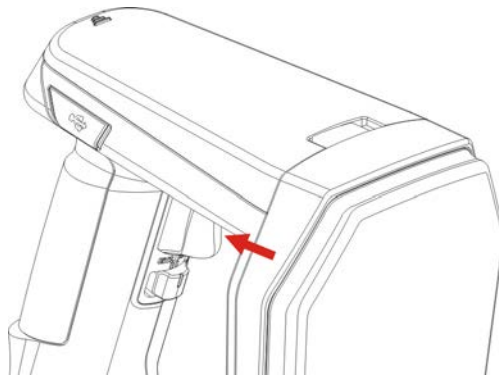

Note: The LED2 will flash blue when you power on the RFID Reader successfully.

CONNECTING USB CABLE

- 1) The RFID Reader has a built-in USB port enabling its connection to host computers for configuration and data transmission.
- 2) Remove the USB port cover.
- 3) Connect the USB communication cable to USB port. (USB logo shall face down)
- 4) Connect the other end of USB cable to the host computer.

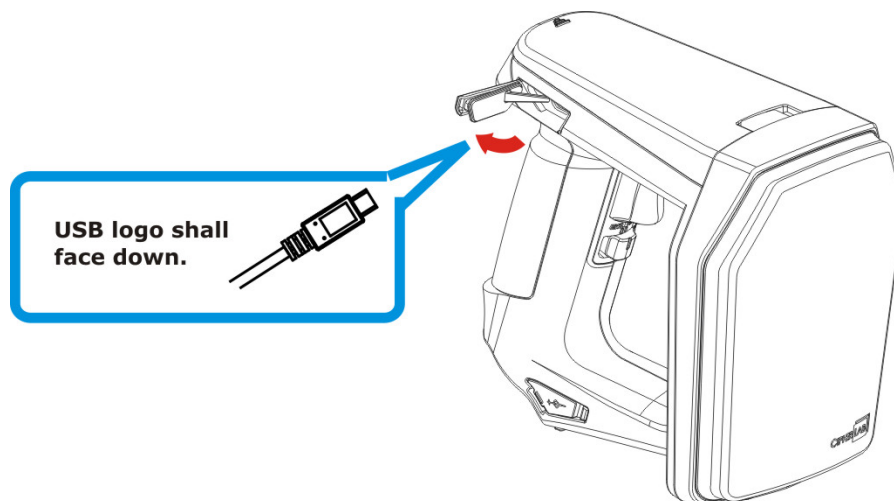

ISSUING COMMANDS VIA USB CONNECTION

USB connection can be used for configuring the Reader and to upload data to host computer. Below are the procedures to create a USB connection before using RFID Reader.

USING HYPERTERMINAL

On the host computer:

- 1) Go to the "Device Manager" on the host computer to confirm the used COM port. For example below, the USB Virtual COM_CDC - COM3 is being used.

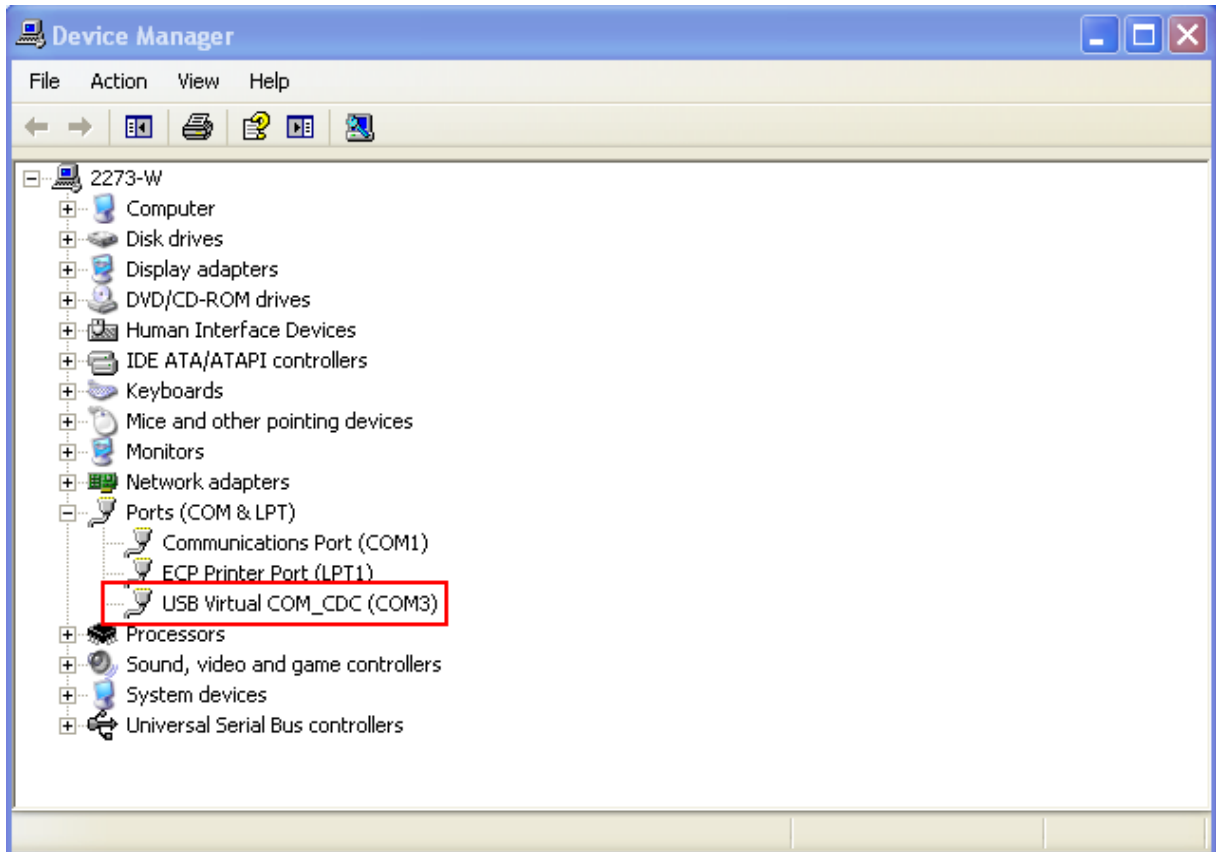

Note: By default the USB Interface type set on 1800 RFID Reader is Virtual COM CDC (CDC and Silicon USB interfaces available). And users are supposed to install the corresponding driver on host computer before beginning to use RFID Reader. Refer to [2.1 USB Interface](#) or [1.3.1.2 Functions](#) used for selecting USB type during operation.

- 2) Use a terminal emulation program, e.g. HyperTerminal, to confirm the connection between host computer and RFID Reader. Open the HyperTerminal on the host computer.
- 3) Enter a name and choose an icon for the connection. Click "OK" to continue.

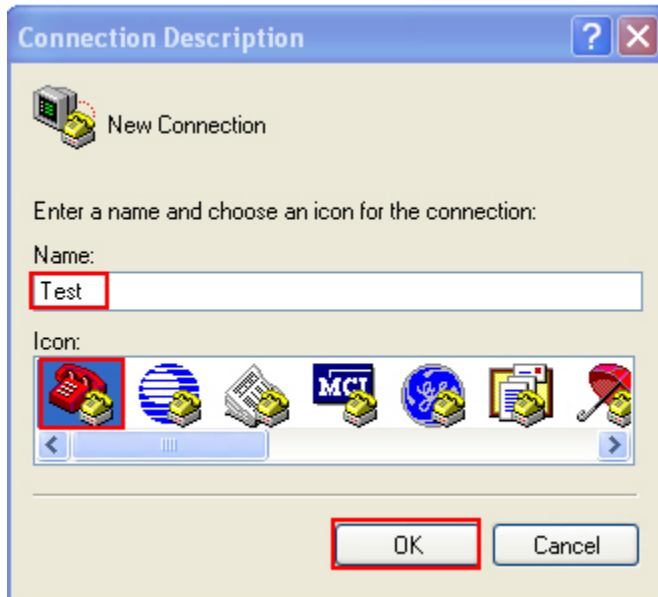

- 4) According to the information of Step 1, select the proper connected COM port, e.g. COM3.

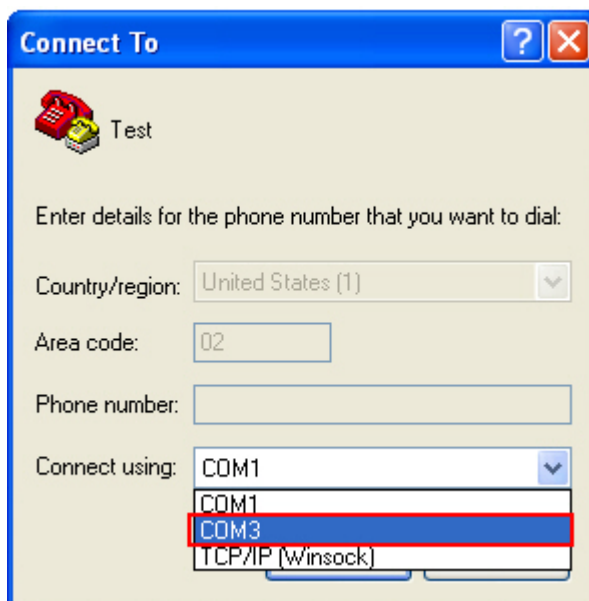

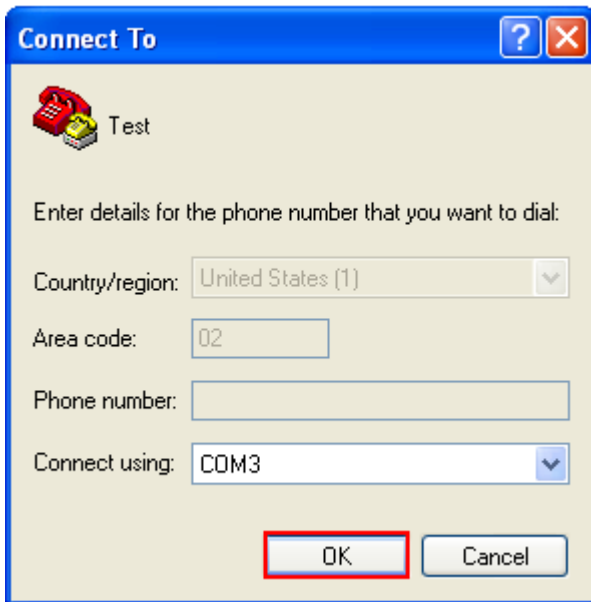

5) Click "OK".

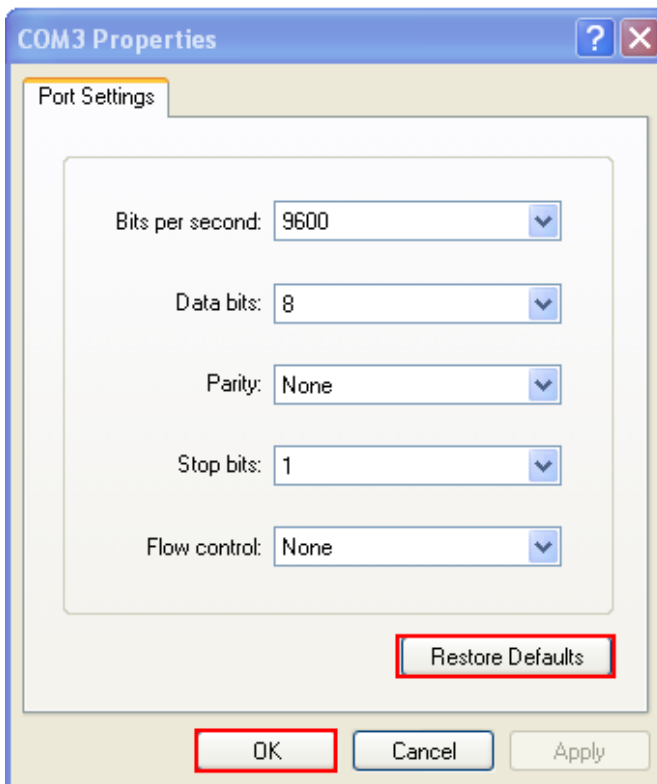

6) In the COM3 Properties window, you can click the "Restore Defaults" to use default values for connection. Then, click "OK".



Note: After finishing the COM Properties configuration, the connected icon on the HyperTerminal will be changed from  to  automatically.

- 7) In the HyperTerminal window, click  on the tool bar to open Properties configuration window, see below. Click "Settings" tab.

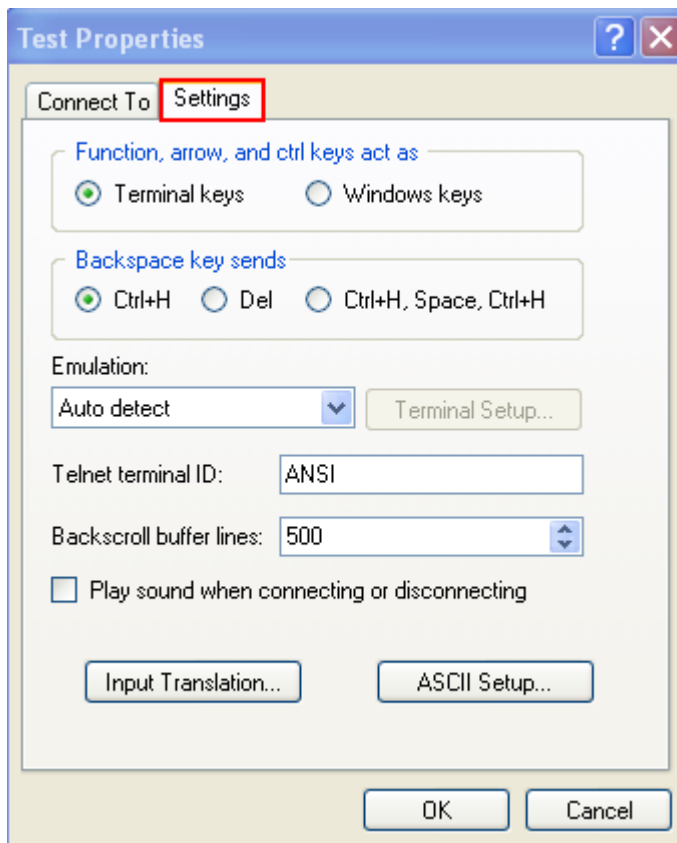

- 8) Click [ASCII Setup] to open ASCII Setup window and some check boxes need to be selected for normalized issuing commands, see below. Click "OK".

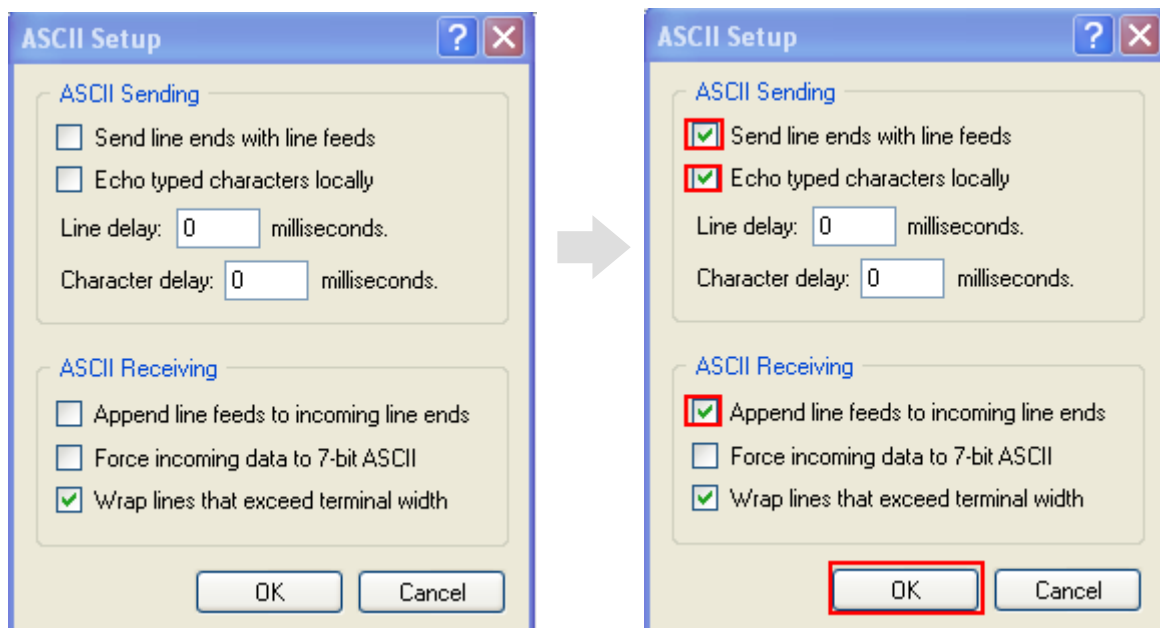

- 9) After finishing ASCII Setup, in the Properties configuration window, click "OK".

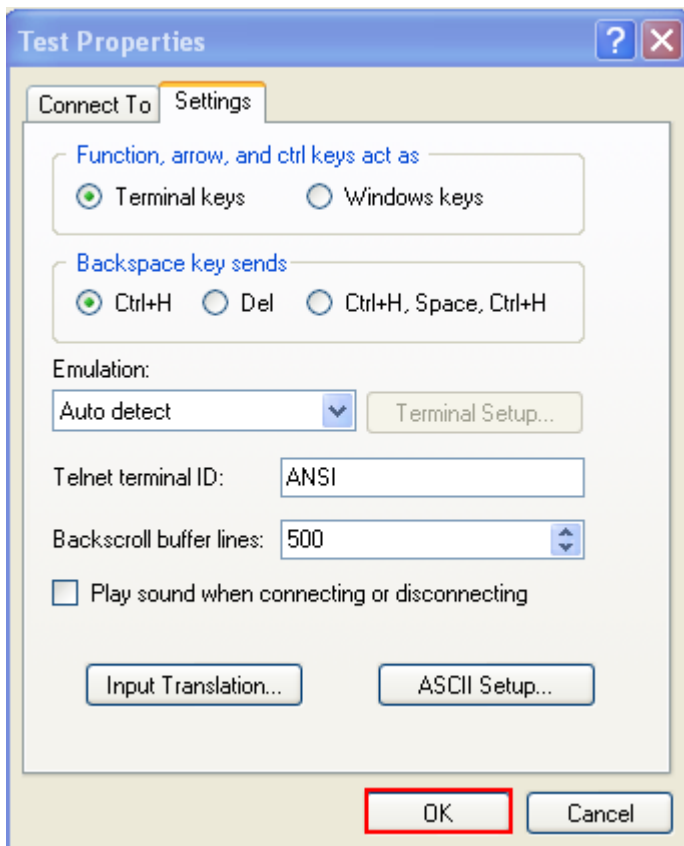

CONFIRMING THE USB CONNECTION

Now, you can begin to issue commands between the host computer and RFID Reader. For example, you can issue "#@sys_info?" command for testing. If the connection is successful, the HyperTerminal will display the following response from the reader.

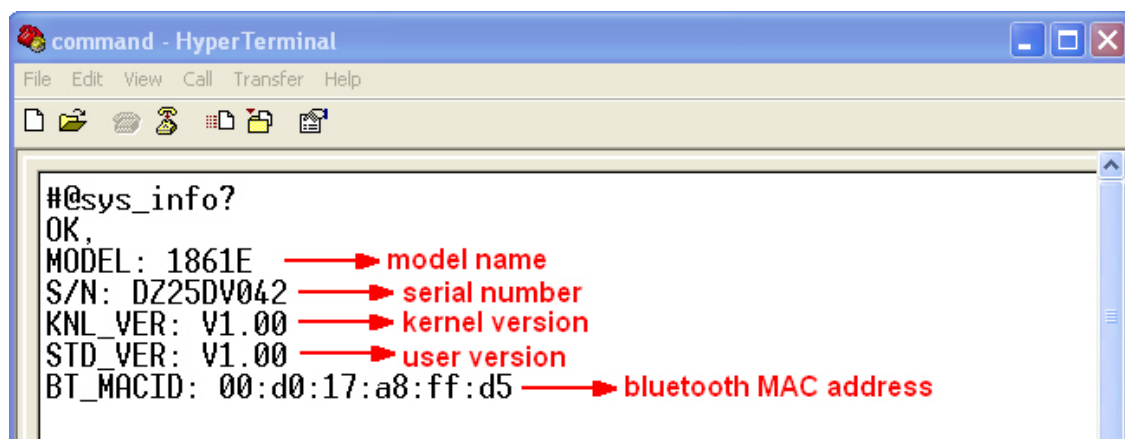

Note: If the connection fails, check whether the USB Interface type is configured correctly. The default value is '127' for virtual COM CDC. Refer to [2.1 USB Interface](#).

DEFAULT SETTINGS

SAVE USER SETTINGS AS DEFAULTS

For the RFID Reader to keep the customized settings as user defaults, you must issue “#@sys_svusrtbl” command.

Note: After issuing the command, the current settings will be saved as user defaults.

Command:

#@sys_svusrtbl\r

Purpose	Save User Defined Setting
Response	OK\r
	ERR,[code]\r

RESTORE USER/FACTORY DEFAULTS

For the RFID Reader to restore the User Defaults, which you have saved earlier, you must issue the “#@sys_ldstbl=1” command. Alternatively, you can also issue the “#@sys_ldstbl=0” command to restore Factory Default.

Command:

#@sys_ldstbl=[m]\r

Purpose	Load Default Setting
Request	#@sys_ldstbl=[m]\r
	[m]: '0' – Factory Default
	'1' – User Default
Response	OK\r
	ERR,[code]\r

Note: Restoring factory defaults may reset any active *Bluetooth*[®] connections and erase the MAC address information of the connected device.

READER SWITCH

RFID Reader supports a switch that is used to toggle between RFID Reader and Alternate trigger scan. Shift the switch to the right for RFID and left for Alternate trigger.



Make sure the reader switch is set to correct location based on RFID or Alternate mode. For more Alternate mode information, please refer to [Alternate Mode](#).

COMBINING WITH A MOBILE COMPUTER

If you wish to combine the RFID Reader with a mobile computer, please remove the mounting plate cover and then install the mobile computer mount. Follow the steps below to remove the mounting plate cover:

- 1) Place the RFID Reader on a flat and clean surface.
- 2) Slide the mounting plate cover latch to unlock position.
- 3) Slide the mounting plate cover smoothly out of the RFID reader.
- 4) Align the mobile computer mount, which may vary depending on the mobile computer you plan to use, with the reader and slide along the guide slots of the reader.
- 5) Install the mobile computer in the mobile computer mount.

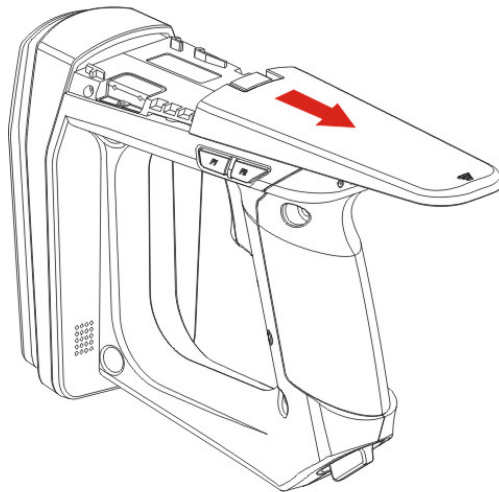
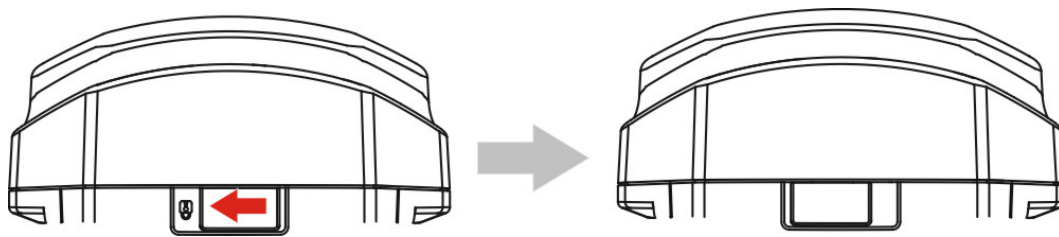

1800 CONFIGURATION

You can configure the RFID Reader by issuing commands or 1800Configuration Utility.

Serial Command:

You may run HyperTerminal.exe on the host computer to send commands to RFID Reader via USB virtual COM or *Bluetooth*[®] SPP. The commands are not case sensitive.

Example:

```
#@sys_time?<CR>
```

→ Get the system time information.

```
#@sys_time=[Y],[M],[D],[h],[m],[s]<CR>
```

→ Set the system time. [Y],[M],[D],[h],[m],[s] are the parameters of system time.

Note: A Serial Command consists of Prefix, Text, and Suffix. The prefix consists of “#” and “@”. “?” or “=” is specified to suffix. \r or <CR> is specified for the “Enter” of your keyboard. As a normal command event, it will respond with “OK” or “ERR”. About “ERR”, please refer to [Status Code](#) for more information.

1800Configuration Utility:

CipherLab supports a Windows[®]-based Software Utility to allow you to configure RFID Reader easily. For more information, please refer to 1800Configuration User Guide.

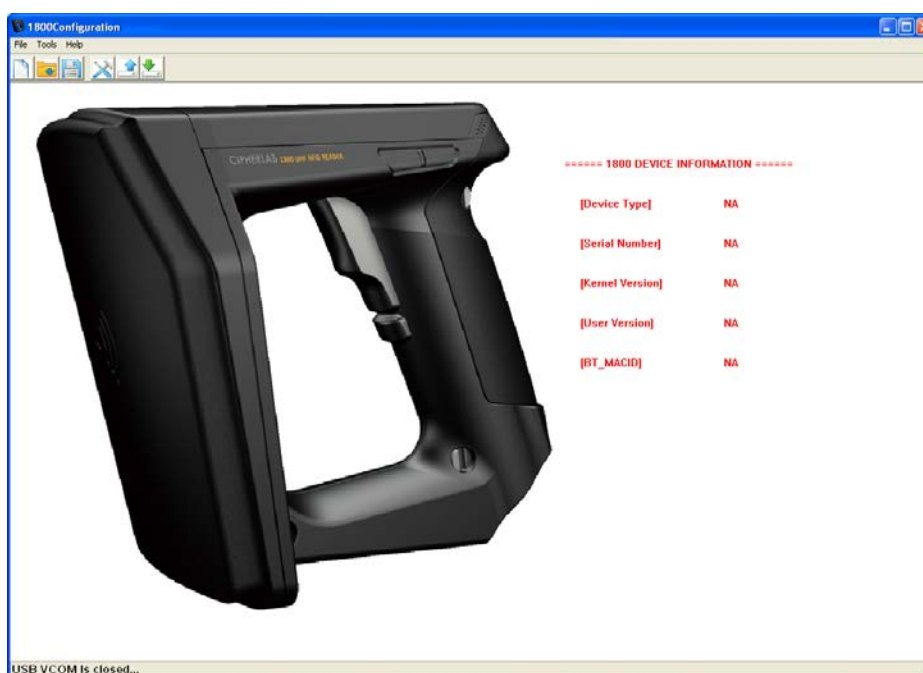

UNDERSTANDING RFID READER

This chapter explains the features and usage of RFID Reader. Before configuring RFID Reader, we will detail the information received when “#@sys_info?” command is issued.

Command:

#@sys_info?\r

Purpose	Get System Information
Response	OK,[m]\r[n]\r[o]\r[p]\r[Q]\r [m]: string that indicates model name “1861E” – Basic UHF type Europe Band “1861U” – Basic UHF type US Band [n]: string that indicates serial number [o]: string that indicates kernel version [p]: string that indicates user version [q]: string that indicates BTMACID ERR,[code]\r

Example:

Command

```
#@sys_info?
```

Response (s)

```
OK,  
MODEL: 1861E           → model name  
S/N: DZ25DV042        → serial number  
KNL_VER: V1.00        → kernel version  
STD_VER: V1:00        → user version  
BT_MACID: 00:d0:17:a8:ff:d5 → Bluetooth® MAC address
```

IN THIS CHAPTER

1.1 Power	21
1.2 Memory	24
1.3 Function Key	31
1.4 LED Indicators	37
1.5 Beeper.....	40
1.6 Vibrator	44
1.7 RTC.....	45
1.8 Event	46

1.1 POWER

RFID Reader is powered by a rechargeable 3.7V/2500mAh Li-ion battery pack, and it takes approximately 4 hours to fully charge it via charger or adapter. During normal operation, the RFID Reader can work for up to 10 hours.

Warning: The battery cover must be in position. If not, the RFID Reader cannot turn on. For a new battery, make sure it is fully charged before you begin to use it. Always prepare a spare battery, especially when you are working on a non-stop operation.

1.1.1 POWER ON

After installing the battery, press the trigger for 2 seconds. The RFID Reader will respond with a long beep (high tone), and LED1 will become solid red for 1 second and go off.

1.1.2 POWER OFF

The RFID Reader will stay active at power-on, which may be followed by a transition from full CPU speed to low CPU speed (Power-Saving) to auto shutdown (Auto Power Off).

Auto Power Off (1~254 min.; 0= Disable): By default, it is set to automatically shut down after idling 10 minutes. If this feature is not desired, set it to 0.

Command:

#@sys_tpoff?\r

Purpose	Get the Delay Time of System Shutdown
Response	OK,[m]\r (Default m= '10')
	[m]: '0' ~ '254' (Unit=minute)
	ERR,[code]\r

#@sys_tpoff=[m]\r

Purpose	Set the Delay Time of System Shutdown
Response	OK\r
	ERR,[code]\r

Press <F1>+<F2> keys for 3 seconds with two short beeps, high tone and then release both keys to force the RFID Reader to shut down. Alternatively you can also issue command on the host computer described below to power off the RFID Reader.

Command:

#@sys_off\r

Purpose	System Shutdown
Response	OK\r
	ERR,[code]\r

1.1.3 POWER SAVING MODE

Power Saving (1~254 min.; 0= Disable): By default, it is set to idle at full-speed for 2 minutes before it enters power saving mode. If this feature is not desired, set it to 0.

Note: The Power Saving setting will not take effect when data is transmitting via *Bluetooth*[®] HID or SPP.

Command:

#@sys_tps?\r

Purpose	Get the Delay Time of Power Saving Mode
Response	OK,[m]\r (Default m= '2')
	[m]: '0' ~ '254' (Unit=minute)
	ERR,[code]\r

#@sys_tps=[m]\r

Purpose	Set the Delay Time of Power Saving Mode
Response	OK\r
	ERR,[code]\r

Note: Power Saving will not take effect when one of the following conditions is met:

- (1) RFID Reader is being configured by the 1800 Configuration Utility.
- (2) The scanning mode is set to Test Mode.
- (3) The setting value of Power Saving is greater than Auto Power Off.

Issue “#@sys_kalive” command to keep system active for a further period of time. Each time with this command issued, the delay time for system shutdown and power saving mode will be reset.

Command:

#@sys_kalive\r

Purpose	Keep the System Alive
Response	OK\r
	ERR,[code]\r

1.1.4 LOW BATTERY ALARM

By default, the battery alarm will beep when the battery charge gets low. In order to prevent data loss, it is advised to replace the battery immediately when hearing two short beeps (high tone).

Command:

#@sys_battery?\r

Purpose	Get Remaining Capacity of Battery
Response	OK,[m],[n]\r
	[m]: remaining battery capacity. (e.g. 100%)
	[n]: charging status
	'0' – not charging
	'1' – being charged
	'2' – fully charged
	ERR,[code]\r

#@sys_lbalarm?\r

Purpose	Get Low Battery Alarm
Response	OK,[m]\r (Default m= '1')
	[m]: '0' – Disable
	'1' – Enable
	ERR,[code]\r

#@sys_lbalarm=[m]\r

Purpose	Set Low Battery Alarm
Response	OK\r
	ERR,[code]\r

Warning: Using *Bluetooth*[®] connection will substantially reduce battery power. Disable the *Bluetooth*[®] function when it is not in use.

1.2 MEMORY

- ▶ Memory Mode
4MB flash for Memory Mode data access.
- ▶ Transmit Buffer Memory
2KB buffer while getting out of range over a wireless personal area network (WPAN)

The RFID reader has 2 modes: online through *Bluetooth*[®], or memory mode where scans are stored and transmitted at a later stage through USB.

1.2.1 TRANSMIT BUFFER

By default, transmit buffer is enabled and used when the RFID Reader is out of range. Upon reading a tag successfully within range, the RFID Reader responds with one short beep (high tone) and LED3 indicator becomes solid green and goes off. When the reader gets out of range, the transmit buffer is used to store scanned tags until the buffer is full or until its back within range.

When transmit buffer is enabled...

If the RFID Reader is out of range, it will respond with two short beeps, high-low tone, upon reading a tag successfully.

When transmit buffer is full, the RFID Reader will respond with one long beep (low tone). You are advised to get back within range.

When transmit buffer is disabled...

If the RFID Reader is out of range, it will respond with one long beep (low tone). You are advised to get back within range.

Command:**#@sys_txben?\r**

 Purpose Get Transmit Buffer Status

 Response OK,[m],[n]\r
 ERR,[code]\r
#@sys_txben=[m] {,[n]}\r

 Purpose Enable Transmit Buffer

[m]: '0' – Disable (default)

'1' – Enable

'2' – Enable passive transmit buffer

[n]: '0' – Keep data until getting “clear buffer” command

'1' – Automatically clear the buffer after data sent (default)

[n] exists only when [m] is set to 2. When [m] is set to 0 or 1, [n] will be reset to default.

Response OK\r

ERR,[code]\r

#@sys_txbdly?\r

 Purpose Get Transmit Buffer Delay

 Response OK,[m]\r
 ERR,[code]\r
#@sys_txbdly=[m]\r

 Purpose Set Transmit Buffer Delay

Request [m] Send TX Buffer Delay

'0'	0 (default)
'1'	250 ms
'2'	500 ms
'3'	1 sec
'4'	2 sec
'5'	3 sec
'6'	5 sec
'7'	8 sec

Response OK\r

ERR,[code]\r

#@sys_txbuf\r

Purpose	Inquire Data from Transmit Buffer
Response	OK\r //command received
	[m]\r //data string
	EOT,[n]\r //End of Transmit. [n] indicates the total data count in buffer.
	ERR,[code]\r

#@sys_txclr\r

Purpose	Clear Transmit Buffer
Response	OK\r
	ERR,[code]\r

1.2.2 MEMORY MODE

The RFID Reader includes 4MB flash memory for data storage when the reader operates in memory mode. When the RFID Reader gets into memory mode, the current *Bluetooth*[®] connection with the host is disabled.

Warning: *Bluetooth*[®] connection is not available in the memory mode.

STATUS

Confirm the memory size by issuing “#@sys_memsize?” command.

Command:

#@sys_memen?\r

Purpose	Get Memory Mode Status
Response	OK,[m]\r (Default m= '0')
	[m]: '0' – Disable
	'1' – Enable
	ERR,[code]\r

#@sys_memen=[m]\r

Purpose	Set Memory Mode
Response	OK\r
	ERR,[code]\r

Note: You can also enter/exit memory mode by pressing function keys. Refer to [1.3.1.2 Functions](#).

#@sys_memsize?\r

Purpose	Get Free Memory Size
Response	OK,[m]\r (Max. 4072)
	[m]: Free Memory Size string in KB
	ERR,[code]\r

DATA DELAY

You may set a delay time between each data record while transmitting data back to the host computer.

Command:

#@sys_memdly?\r

Purpose Get Data Transmission Delay

Response OK,[m]\r (Default m= '0')

[m]: '0'~'7'

Data Transmission Delay

Value	Delay
'0'	0 ms
'1'	250 ms
'2'	500 ms
'3'	1 sec
'4'	2 sec
'5'	3 sec
'6'	5 sec
'7'	8 sec

ERR,[code]\r

#@sys_memdly=[m]\r

Purpose Set Data Transmission Delay

Response OK\r

ERR,[code]\r

SEND DATA

To transmit the data to the host immediately, use the following command "#@sys_memup".

Command:

#@sys_memup\r

Purpose	Upload Memory Data
Response	OK\r //command received
	[m]\r //data string
	EOT,[n]\r //End of Transmit. [n] indicates the total data count.
	ERR,[code]\r

CLEAR MEMORY

Even though data has been sent back to the host, the flash memory is still occupied with the scanned data which can be uploaded repeatedly unless you erase the memory by issuing "#@sys_memclr" command to clear memory.

Command:

#@sys_memclr\r

Purpose	Clear Memory
Response	OK\r
	ERR,[code]\r

Example:

Command

#@sys_memsize? → get current memory size

Response (s)

OK, 4072

Command

#@sys_memen=1 → enter memory mode

Response (s)

OK

Command

#@sys_memdly=4 → set the delay time of data transmission to 2 sec.

Response (s)

OK

Command

#@sys_memup → upload memory data

Response (s)

- 1. 2012-04-18 30003430333130303132303030304221] →
- 2. 2012-04-18 30003430333130303132303030304221] →
- 3. 2012-04-18 30003430333130303132303030304221] →

OK

Command

#@sys_memclr → clear memory size

Response (s)

OK

1.3 FUNCTION KEYS

The function keys serve as a modifier key, and the functionality of each key combination is application-dependent.

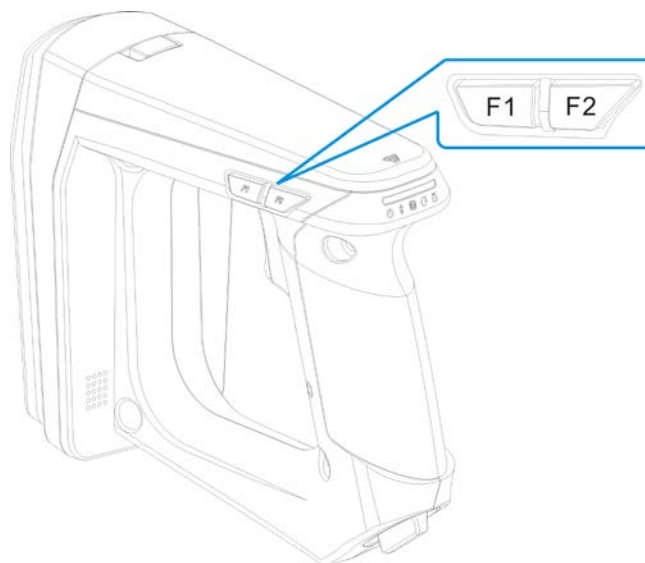

Keys	Action	Mode
<Trigger>	Scan Tag	RFID
	Select number 1~5	<i>Bluetooth</i> [®] Pairing
	Send string	Alternate
<F1>	Execute special function	RFID
	Switch the LED status between power level, BT signal level, data memory space level	RFID
	Send string	Alternate
<F2>	Select special function	RFID
	Send string	Alternate
	Put selected number to PIN Code buffer	<i>Bluetooth</i> [®] Pairing
<F1>+<F2>	Power off the system	RFID, Alternate
	Switch among special command group	RFID
	Erase PIN Code	<i>Bluetooth</i> [®] Pairing
<F1>+<Trigger>	Select number 6~0	<i>Bluetooth</i> [®] Pairing
	Send string	Alternate
<F2>+<Trigger>	Send PIN Code to paired BT device	<i>Bluetooth</i> [®] Pairing
	Send string	Alternate
	Firmware Upgrade	Refer to Firmware Upgrade
<F1>+<F2>+<Trigger>	Cancel the pairing	<i>Bluetooth</i> [®] Pairing
Reader Switcher	Used to switch the RFID and Alternate mode	

1.3.1 RFID MODE

1.3.1.1 FUNCTION KEY FOR POWER OFF

Press <F1>+<F2> keys for 3 seconds with two short beeps, high tone and then release both keys to power off the RFID Reader.

1.3.1.2 FUNCTIONS

Press <F1>+<F2> to switch between Group1, Group2 and Group3

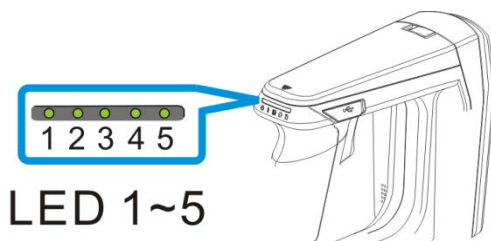
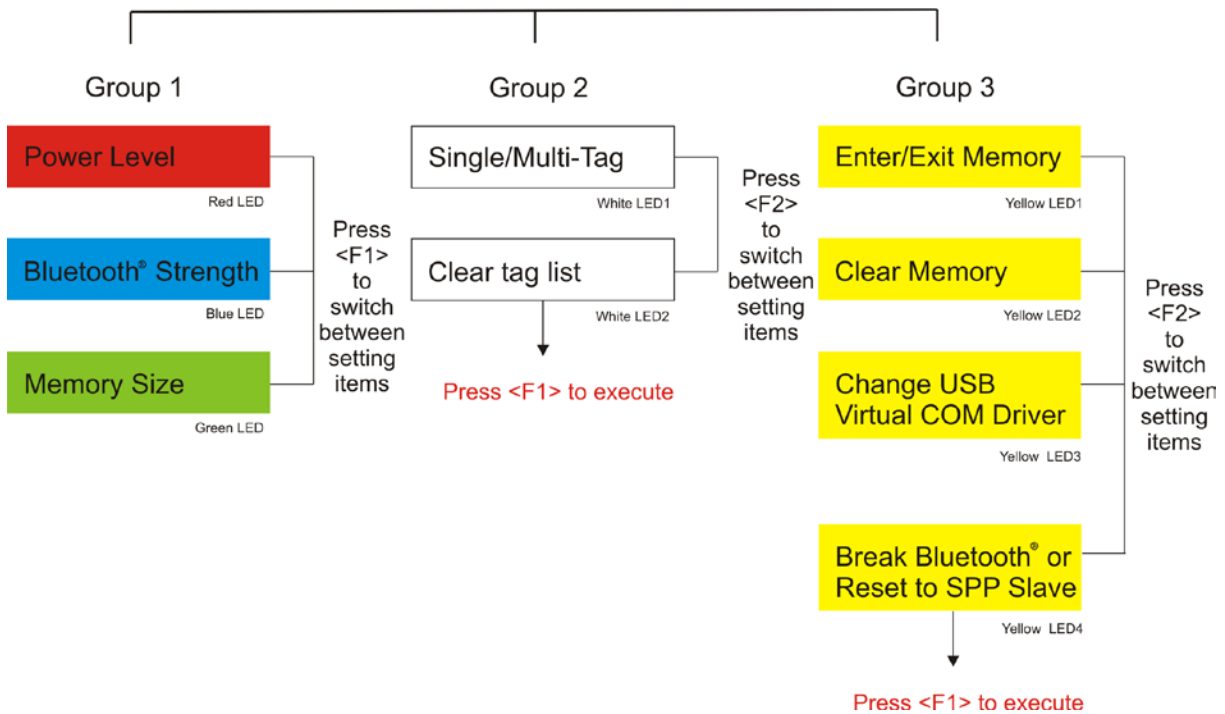

Note: Press <F1>+<F2> to switch between Group1, Group2 or Group3. The 3 groups of function key commands are only available in RFID mode. In Alternate mode, the function keys are only used for keypad output strings.

Group1 System Status (Green LED1): 

Press <F1>+<F2> to enter Group1 with Green LED1. In the Group1, you can press <F1> to switch among Battery Status, *Bluetooth*[®] Signal Quality, and Data Memory Space. After idling for 3-seconds timeout, the LED status will return to normal mode.

▶ Power Level (Red LED)



▶ *Bluetooth*[®] Signal Strength (RSSI) (Blue LED)



▶ Available Memory Capacity (Green LED)

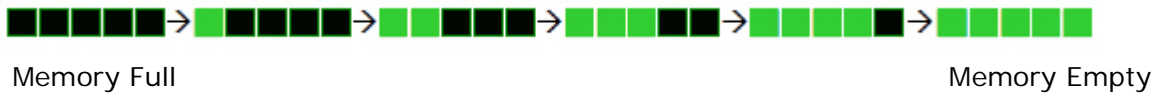

Note: You must have an active *Bluetooth*[®] connection to display the *Bluetooth*[®] signal strength.

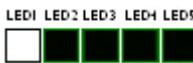
Group2 RFID Assistance (White LED1): 

Press <F1>+<F2> to switch to Group2 with White LED1. The Group2 includes two defined commands (Command1 and 2). Press <F2> to switch between Command1 and Command2; press <F1> to execute the command. The LED status will return to normal mode when you idle for about 3 seconds during configuration.

- ▶ Command1: Set Single or Multi-Tag Scan Mode. With F1 pressed, two beeps with tones ascend from low to high.
(As serial commands: "#@rf_scan=6" or "#@rf_scan=9")
- ▶ Command2: Clear the tag list for Multi-Tag Scan Mode. With F1 pressed, two beeps with tones ascend from low to high.
(As serial command: "#@rf_mtagcnt=")

Press <F2> to switch between Command 1 and 2 (each press two beeps with tones ascending from low to high).

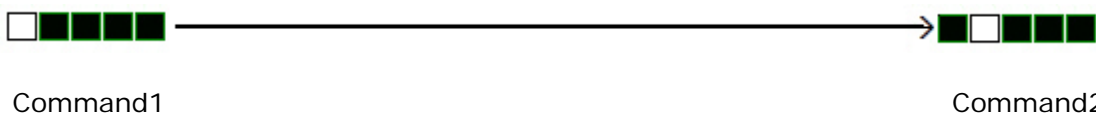

Executing:

Function	Key Operation	LEDs Status
Command1	<F1>+<F2> ⇄ <Executing>	
Command2	<F1>+<F2> → <F2> → <F1: Executing>	

Group3 Others (Yellow LED1):

Press <F1>+<F2> to switch to Group3 with Yellow LED1. The Group3 is defined to 4 commands. Press <F2> to switch among the Commands or press <F1> to execute the command. The LED status will return to normal mode when you idle about 3 seconds during configuration.

- ▶ Command1: Enable/Disable memory mode.
(As serial command: "#@sys_memen=1/0")
- ▶ Command2: Clear data memory.
(As serial command: #@sys_memclr)
- ▶ Command3: Select USB virtual COM driver (Switch between CDC and SiliconLab).
(As serial command: #@usb_type=127/128)

Note: By default, the value of the reader for USB Virtual COM driver is CDC (usb type=127). Press <F1> one time upon command3 to switch to SiliconLab type if you are using SiliconLab driver as a Virtual COM connection. Wrong VCOM type selection will cause disconnection to the host.

- ▶ Command4:
 - a. Breaks the current connection if *Bluetooth*[®] connection exists.
 - b. If there's no *Bluetooth*[®] connection, resets the connection type to default – SPP slave.
 (depending on the *Bluetooth*[®] connection status, it is to run the serial command "#@bt_disc" or "#@bt_reset")

Press <F2> to switch between Command 1, 2, 3 and 4

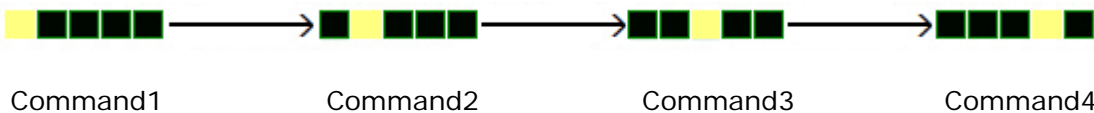

Note: Except for function keys, you can also issue command to break or reset the *Bluetooth*[®] connection. Refer to [3.3.1 Break a Connection](#) and [3.3.2 Reset a Connection](#).

1.3.2 BLUETOOTH® PAIRING MODE

For *Bluetooth*® connection requiring PIN code input, you can use Function key and <Trigger> combination to input numeric codes.

Various numeric input will show you different LED status illustrated below:

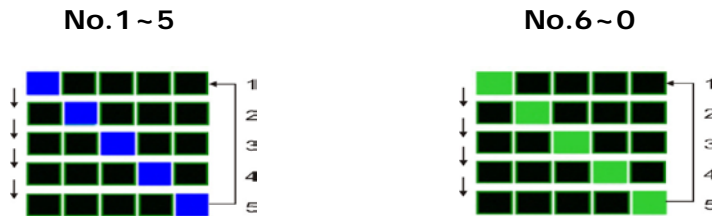

PIN CODE Input for *Bluetooth*® Pairing:

Number Input	Key Operation	LEDs Status
Number 1	<Trigger> once → < F2 >	
Number 2	<Trigger> twice → < F2 >	
Number 3	<Trigger> three times → < F2 >	
Number 4	<Trigger> four times → < F2 >	
Number 5	<Trigger> five times → < F2 >	
Number 6	<F1+Trigger> once → < F2 >	
Number 7	<F1+Trigger> twice → < F2 >	
Number 8	<F1+Trigger> three times F2↵	
Number 9	<F1+Trigger> four times → < F2 >	
Number 0	<F1+Trigger> five times → < F2 >	
Send PIN Code	<F2> + <Trigger>	
Erase the PIN Code	<F1> + <F2>	
Cancel the Pairing	<F1> + <F2> + <Trigger>	

1.3.3 ALTERNATE MODE

This mode is only used for sending key signal to host. For more information, please refer to [Chapter 6 Alternate Mode](#).

Note: You can press <F1>+<F2> keys for 3 seconds to power off RFID reader in alternate mode.

1.4 LED INDICATORS

The five LEDs on the RFID Reader are used to provide a feedback to users about the behavior of the RFID Reader. For example, the LED1 becomes solid red and goes off upon powering on.

The status of LED indicators may vary depending on working modes – General, Function Key and *Bluetooth*[®] Pairing Modes.

1.4.1 GENERAL MODE

In General mode LEDs show you normal system status without any advanced configuration.

LED	Color	Status	Description
LED1-Power	Red	On-Off	Power on, with one long beeps (high tone, LED1 on for 1 second and then off.)
	Red	On	Charging failure occurs
	Red	Flashing	Charging (On/Off ratio 0.5s:0.5s)
	Green	Flashing	Charging Done (On/Off ratio 0.5s:0.5s)
LED2- <i>Bluetooth</i> [®] Communication	Blue	Flashing	On/Off ratio 0.5s:0.5s indicates the RFID Reader is waiting for connection
			On/Off ratio 0.1s:0.1s indicates the RFID Reader receives a PIN code request from host (flashing more quickly than waiting connection)
			On/Off ratio 0.02s:3s indicates the RFID Reader has established a <i>Bluetooth</i> [®] connection successfully.
LED3-RFID Tag Access	Green	On-Off	Good Read/Write with one short beeps (high tone). The pitch and duration are programmable.
LED4-Data Transmission	Green	Flashing	Indicate the data is transmitted between RFID Reader and host. The speed of flashing varies with data rate.
LED5-Memory Status	Green	Flashing	Flashing ((On/Off ratio 0.02s:3s) indicates Free memory size > 10% ** Only for memory mode
	Red	Flashing	Flashing (On/Off ratio 0.02s:3s) indicates memory under 10% ** Only for memory mode

Note: You can configure the good read LED3 status (disable/enable) and duration (ranging from 1 to 254 in units of 10 milliseconds) by command. When you set the LED3 feedback as disable, the LED3 will always be off.

GOOD READ LED STATUS

You may configure the LED3 status for a feedback about good read.

Command:

#@sys_leden?\r

Purpose Get Good Read LED Status
Response OK,[m]\r (Default m= '1')
 [m]: '0' – Disable
 '1' – Enable
 ERR,[code]\r

#@sys_leden=[m]\r

Purpose Set LED Good Read Status
Response OK\r
 ERR,[code]\r

GOOD READ LED DURATION

For a good read for LED3, you may configure the duration time.

Command:

#@sys_leddu?\r

Purpose Get Good Read LED Duration
Response OK,[m]\r (Default m= '4')
 [m]: Duration='1' ~ '254'
 ERR,[code]\r

#@sys_leddu=[m]\r

Purpose Set LED Duration
Response OK\r
 ERR,[code]\r

1.4.2 FUNCTION KEY MODE

LEDs indicate the corresponding functions according to function key combinations. Please refer to [1.3.1.2 Function](#).

1.4.3 *BLUETOOTH*[®] PAIRING MODE

LEDs indicate the number which are input by function keys during *Bluetooth*[®] pairing. Please refer to [1.3.2 Bluetooth[®] Pairing Mode](#).

1.5 BEEPER

The RFID Reader has a beeper to provide feedback in various operating conditions.

Function	Beeping
Power on, with Red LED1 on (1 second) and off	One long beep, high tone
<ul style="list-style-type: none"> ▶ Good read, with Green LED3 on-off ▶ Enter PIN code ▶ Switch among status LED mode ▶ Programmable, default to 4KHz 	One short beep, high tone
<ul style="list-style-type: none"> ▶ Select PIN code ▶ Multi_Tag Mode: Get a repeated tag (Default: Disable) 	One short beep, low tone
<ul style="list-style-type: none"> ▶ Fail to send data or response <ul style="list-style-type: none"> - Transmit buffer full - Transmit buffer is disabled while <i>Bluetooth</i>[®] is not connected or out of range. ▶ Command fail 	One long beep, low tone
<ul style="list-style-type: none"> ▶ Data saved to buffer when transmit buffer is enabled and the RFID Reader is out of range ▶ Memory Mode: Memory full 	Two short beeps, high-low tone
<ul style="list-style-type: none"> ▶ Command success ▶ Send PIN code ▶ Running out of transmit buffer 	Two short beeps, low-high tone
<ul style="list-style-type: none"> ▶ Low battery alarm ▶ Clear PIN code ▶ Power off 	Two short beeps, high tone
<ul style="list-style-type: none"> ▶ <i>Bluetooth</i>[®] connection is established ▶ <i>Bluetooth</i>[®] connection is resumed, with LED2 flashing blue 	Three short beeps, tone ascending from low to high
<i>Bluetooth</i> [®] connection out of range or suspended	Three short beeps, tone ascending from high to low
Multi_Tag Mode: Tag list is full (scan session completes) (Default: Disable)	Six short beeps, low-mid-high-low-mid-high
<ul style="list-style-type: none"> ▶ Low voltage (under 5%) with warning continual beeps ▶ The battery is removed during charging 	Continual beeps

When the battery voltage is under 5%, the reader will beep continuously. We suggest it is better to charge the battery immediately before the RFID Reader is powered off. You can get the voltage information by issuing "sys_battery?" command.

The commands below describe the beeper related configurations:

VOLUME

There are four volume levels defined to beeping setting.

Command:

#@sys_bpvol?\r

Purpose Get Beeper Volume
 Response OK,[m]\r (Default m= 'High')

[m]: Volume

'0'	Mute
'1'	Low
'2'	Medium
'3'	High

ERR,[code]\r

#@sys_bpvol=[m]\r

Purpose Set Beeper Volume
 Response OK\r

ERR,[code]\r

COMMAND BEEP

By default, this function is disabled.

Command:

#@sys_cmdbp?\r

Purpose Get Status of Command Indicating Beep
 Response OK,[m]\r (Default m= '0')

[m]: '0' – Disable

'1' – Enable

ERR,[code]\r

#@sys_cmdbp=[m]\r

Purpose Set Command indicating Beep
 Response OK\r

ERR,[code]\r

GOOD READ

You have to enable the beeping function when you want to get audio feedback from RFID Reader.

Command:

#@sys_grdbp?\r

Purpose Get Status of Good-Read Beep
Response OK,[m]\r (Default m= '1')
[m]: '0' – Disable
 '1' – Enable
ERR,[code]\r

#@sys_grdbp=[m]\r

Purpose Set Status of Good-Read Beep
Response OK\r
ERR,[code]\r

FREQUENCY

By default, the frequency for a beeper is configured to 4KHz. This function is available when Good-Read beep is enabled.

Command:

#@sys_grdbf?\r

Purpose Get Beeper Frequency
Response OK,[m]\r (Default m= '1')
[m]: Frequency

'0'	8 kHz
'1'	4 kHz
'2'	2 kHz
'3'	1 kHz

ERR,[code]\r

#@sys_grdbf=[m]\r

Purpose Set Beeper Frequency
Response OK\r
ERR,[code]\r

DURATION

You can configure the beeping duration to shortest, short, longer or longest. This function is available when Good-Read beep is enabled.

Command:**#@sys_grdbdu?\r**

Purpose Get Beeper Duration

Response OK,[m]\r (Default m= 'Shortest')

[m]: Duration

'0'	Shortest
'1'	Short
'2'	Longer
'3'	Longest

ERR,[code]\r

#@sys_grdbdu=[m]\r

Purpose Set Beeper Duration

Response OK\r

ERR,[code]\r

Note: When you set the volume of beeper to mute, there will be no audio feedback.

1.6 VIBRATOR

The RFID Reader has a built-in vibrator, which can be issued command for feedback. This can be helpful when working in noisy environments.

For good read/write, the vibrator will vibrate for 1 second then stop. The vibration and duration are programmable.

STATUS

RFID Reader supports a vibration option that you can enable/disable by issuing “#@sys_viben=” command.

Command:

#@sys_viben?\r

Purpose	Get Vibrator Status
Response	OK,[m]\r (Default m= '0')
	[m]: '0' – Disable
	'1' – Enable
	ERR,[code]\r

#@sys_viben=[m]\r

Purpose	Set Vibrator Status
Response	OK\r
	ERR,[code]\r

DURATION

By default, a good read vibration stays on for 1 second. Specify a value, ranging from 1 to 254 in units of 100 milliseconds.

Command:

#@sys_vibdu?\r

Purpose	Get Vibrator Duration
Response	OK,[m]\r (Default m= '10')
	[m]: Duration='1' ~ '254'
	ERR,[code]\r

#@sys_vibdu=[m]\r

Purpose	Set Vibrator Duration
Response	OK\r
	ERR,[code]\r

1.7 RTC

RFID Reader supports a Real Time Clock to keep track of the current time.

Command:**#@sys_time?\r**

Purpose	Get System Clock
Response	OK,[Y],[M],[D],[h],[m],[s]\r
	[Y]: '00' ~ '99'
	[M]: '01' ~ '12'
	[D]: '01' ~ '31'
	[h]: '00' ~ '23'
	[m]: '00' ~ '59'
	[s]: '00' ~ '59'
	ERR,[code]\r

#@sys_time=[Y],[M],[D],[h],[m],[s]\r

Purpose	Set System Clock
Response	OK\r
	ERR,[code]\r

Example:**Command**

#@sys_time? → get current system time

Response (s)

OK,12,05,10,10,36,05 → date=2012/5/10, time=10:36 05

Command

#@sys_time=12,06,20,12,50,00 → set system date and time to 2012/6/20 12:50 00

Response (s)

OK

1.8 EVENT

Users can retrieve the current event settings and set them by purpose.

Command:

#@sys_evt?\r

Purpose Get Current Event Settings

Response OK,[m],[n]\r

m: The event setting is shown in 4-digit hexadecimal. Refer to the Event table below.

n: '0' – Disable (default)

'1' – Enable that events can be sent via USB if BT is not connected.

Bit	Default	Meaning
0	1	System will enter PS mode after this event.
1	1	System will shut down after this event.
2	1	Bluetooth will be disconnected after this event.
3	1	System setting is changed (by command via USB or FN key), which is indicated by sending the Group Code and Command Code in the Event packet.
4	0	Low Battery Alarm. 1800 sends this event every 30 seconds if battery voltage is lower than 3.6V.
5	1	Mode switching between Alternate and RFID.
6	1	RFID failure (initial failure or no response during operating)
7	0	No tag is found when scan session times out in single mode
8	0	scan session completes in multi-tag mode (new tag amount is equal to multi-tag counter)
9	0	Memory Mode/BT Mode switched
15~10	0	Reserved

ERR,[code]\r

Remark For example, Event code 001C (0000 0000 0001 1100) means "Low Battery" alarm, "System Setting Changed" and "Bluetooth Will Be Disconnected" events occur.

#@sys_evt=[m],[n]\r

Purpose Set Event Settings

Response OK\r

ERR,[code]\r

#@evt[m],[n]\r

Response m: event code

n: command code which appears only when bit 3 of the event code is set.

COMMUNICATION INTERFACE

Follow the sections below for output interfaces supported to establish USB and WPAN connection with RFID Reader. Refer to the table as below:

1800 Communication Interface:

Interface		Configuration	RFID Data Out	Upload Memory Data
Bluetooth®	SPP Slave	v	v	v
	SPP Master	v	v	v
	HID		v	
	3610 Virtual COM	v	v	v
	3610 HID		v	
USB	Virtual COM Windows CDC Driver/SiliconLab Driver	v	V (*)	v

Note: ‘*’ means that RFID data can be output via USB Virtual COM only when users have carried out the “#@dat_2usb=1” command. Please refer to [5.4 Output EPC Data via USB Virtual COM](#).

IN THIS CHAPTER

2.1 USB Interface	48
2.2 <i>Bluetooth</i> ® Connection Type	49
2.3 <i>Bluetooth</i> ® SPP Slave	50
2.4 <i>Bluetooth</i> ® SPP Master	50
2.5 <i>Bluetooth</i> ® HID	51
2.6 USB VCOM and HID via 3610	61

Note: By default, the output interface is set to “SPP Slave”.

2.1 USB INTERFACE

Create a connection between RFID Reader and host computer; you have to select the available USB interface type by the "#@usb_type=" command. You can also use the function keys to switch between the USB interface types, refer to [1.3.1.2 Functions](#).

Command:

#@usb_type?\r

Purpose	Get USB Interface Type
Response	OK,[m]\r (Default m='127') [m]: USB Type '127' – Virtual COM CDC '128' – Virtual COM (Silicon Lab driver) ERR,[code]\r

#@usb_type=[m]\r

Purpose	Set USB Interface
Response	OK\r ERR,[code]\r

2.2 BLUETOOTH® CONNECTION TYPE

1800 RFID reader is capable of various *Bluetooth*® connection for different target requirements. By default, the connection type is configured to “SPP Slave”.

Command:

#@bt_type?\r

Purpose Get *Bluetooth*® Interface Type

Response OK,[m]\r (Default m= '0')

[m]: *Bluetooth*® TYPE

Bluetooth® Type	Description	Read only / R/W
'0'	SPP Slave	R/W
'3'	SPP Master	R/W
'5'	HID	R/W
'6'	3610	Read only

ERR,[code]\r

#@bt_type=[m]\r

Purpose Set *Bluetooth*® Interface Type

Response OK\r

ERR,[code]\r

2.3 BLUETOOTH® SPP SLAVE

For *Bluetooth*® SPP Slave, issue the “#@bt_type=” to parameter ‘0’ for output interface. Then, refer to [Setting Up a WPAN Connection](#) for related connection settings. By default, RFID Reader connection type is configured to “SPP Slave”.

Example:

Command	
#@bt_type?	→ get current <i>Bluetooth</i> ® type
Response (s)	
OK,0	→ default <i>Bluetooth</i> ® type is ‘0’ for SPP Slave
Command	
#@bt_type=0	→ set <i>Bluetooth</i> ® type to SPP Slave
Response (s)	
OK	

2.4 BLUETOOTH® SPP MASTER

As a SPP master device, RFID Reader will be able to resume connection with the host computer upon powering on again, as long as the host application is running. If RFID Reader fails to resume connection, it will try every 5 seconds to re-connect to the host computer unless you issue the "#@bt_reset" or "#@sys_ldstbl=" command.

For *Bluetooth*® SPP Master Connection, refer to [3.1.4 Bluetooth® SPP Master](#).

Note: In SPP Master Mode, RFID Reader has to connect within the specified period of time (2 minutes by default). During the connection, the RFID Reader will enter Power Saving Mode. It will automatically power off when the Auto Shutdown time is reached. Refer to [1.1 Power](#).

2.4.1 ACTIVATE BLUETOOTH® SPP MASTER MODE

How to connect with the target machine?

Two parameters are necessary using "#@bt_target=" command for SPP Master connection. One is to configure connection type as SPP Master; the other is MAC ID of the target machine.

Command:

#@bt_target?\r

Purpose	Get <i>Bluetooth</i> ® Target Machine
Response	OK,[m],[n]\r [m]: <i>Bluetooth</i> ® Type, '0' – SPP Master, '1' – 3610 [n]: MACID of target Machine or S/N of 3610 ERR,[code]\r

#@bt_target=[m],[n]\r

Purpose	Set <i>Bluetooth</i> ® Target Machine
Response	OK ERR,[code]

Exit SPP Master Mode

To stop such re-connection, you can issue the "#@bt_reset" command so that the current connection record (= MAC ID) will be cleared. Connection type will also be restored to default (SPP Slave). Go through the whole process in [Setting Up a WPAN Connection](#) to establish a new WPAN connection.

2.5 BLUETOOTH® HID

For *Bluetooth*® HID connection, issue the “#@bt_type=” command with parameter ‘5’. Refer to [Using HyperTerminal](#) for related connection settings. To capture the data, run any text editor on host computer and the scanned data will be transmitted to the host computer.

HID Settings	Defaults
Keyboard Type	PCAT (US)
Alphabets Layout	Normal
Numeric Layout	Normal
Capital Lock Type	Normal
Capital Lock State	Off
Alphabets Transmission	Case-sensitive
Numeric Transmission	Alphanumeric keypad
Inter-Character Delay	0 (ms)

2.5.1 ACTIVATE *BLUETOOTH*® HID & SELECT KEYBOARD TYPE

When *Bluetooth*® HID interface is activated, you will have to select a keyboard type to complete this setting. By default, *Bluetooth*® HID is activated with PCAT (US) type on the RFID Reader.

Bluetooth® HID

The following keyboard types are supported —

No.	Keyboard Type	No.	Keyboard Type
64	PCAT (US) (Default)	71	PCAT (Belgium)
65	PCAT (French)	72	PCAT (Spanish)
66	PCAT (German)	73	PCAT (Portuguese)
67	PCAT (Italy)	74	PS55 A01-2 (Japanese)
68	PCAT (Swedish)	75	Reserved
69	PCAT (Norwegian)	76	PCAT (Turkish)
70	PCAT (UK)	77	PCAT (Hungarian)

Command:**#@bt_hididx?**Purpose Get *Bluetooth*[®] HID Parameter Index

Response OK,[m]\r

[m]: Parameter Index

[m]	Description	Valid Parameters
'0'	HID KBD Type	'64' ~ '77' (Default m='64')
'3'	Inter-function Delay	'0' ~ '254' (Default m='0')
'4'	Inter-character Delay	'0' ~ '254' (Default m='0')
'5'	Caps Lock State	'0' – OFF (Default) '1' – ON '2' – Auto
'7'	Alphabets Transmission	'0' – Case Sensitive (Default) '1' – Ignore Case
'8'	Digits Transmission	'0' – Alpha Numeric Keypad (Default) '1' – Numeric Keypad
'9'	Digits Position	'0' – Normal (Default) '1' – Lower Row '2' – Upper Row
'10'	Keyboard Layout	'0' – Normal (Default) '1' – AZERTY '2' – QWERTZ
'12'	HID Character Transmit Mode	'0' – Batch Processing (Default) '1' – By Character
'15'	HID Speed Mode	'0' – Normal (Default) '1' – Fast

ERR,[code]\r

#@bt_hididx=[m]Purpose Set *Bluetooth*[®] HID Parameter Index

Response OK\r\r

ERR,[code]

#@bt_hidpr?\r

Purpose Get *Bluetooth*[®] HID Parameter
Response OK,[m]\r
[m]: Parameter
ERR,[code]\r

#@bt_hidpr=[m]\r

Purpose Set *Bluetooth*[®] HID Parameter
Response OK\r
ERR,[code]\r

Example:

Command

#@bt_type=5 → change connected interface to BT HID

Response (s)

OK

Command

#@bt_hididx=0 → enter HID KBD type configuration

Response (s)

OK

Command

#@bt_hidpr=64 → set PCAT (US) for KBD type

Response (s)

OK

2.5.2 KEYBOARD SETTINGS

- ▶ Alphabets Layout
- ▶ Numeric Layout
- ▶ Capital Lock Setting
- ▶ Alphabets Transmission
- ▶ Numeric Transmission

ALPHABETS LAYOUT

By default, the alphabets layout is set to normal mode, also known as the standard English layout. Select French or German keyboard layout if necessary. The RFID Reader will make adjustments when sending the "A", "Q", "W", "Z", "Y", and "M" characters according to this setting.

Options	Parameter	Description
Normal (Default)	'0'	US keyboard.
AZERTY	'1'	French keyboard.
QWERTZ	'2'	German keyboard.

Note: This setting only works when the keyboard type selected is US keyboard, such as PCAT (US). The Alphabets Layout and Numeric Layout setting must match your keyboard.

US KEYBOARD STYLE – NORMAL

QWERTY layout, which is normally used in western countries.

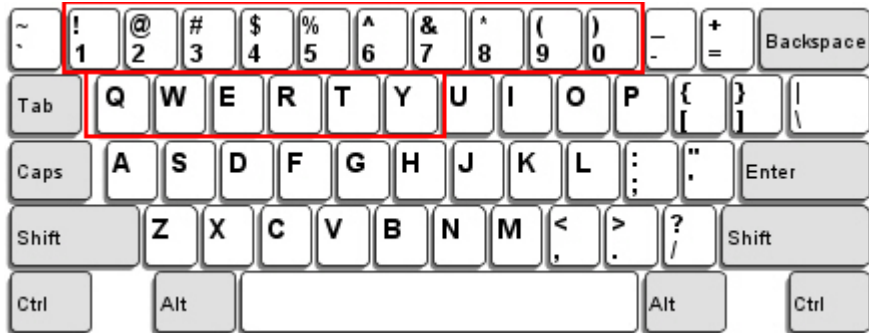

- ▶ Select “Lower Row” for the “Numeric Layout” setting for the upper row is for special characters.

FRENCH KEYBOARD STYLE – AZERTY

French layout; see below for French Keyboard Style.

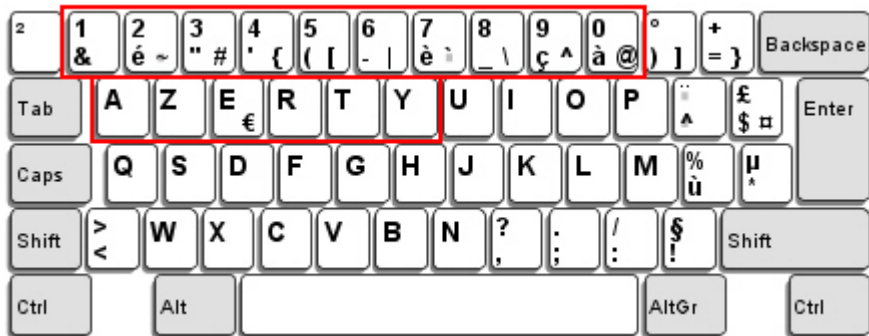

- ▶ Select “Upper Row” for the “Numeric Layout” setting for the lower row is for special characters.

GERMAN KEYBOARD LAYOUT – QWERTZ

German layout; see below for German Keyboard Style.

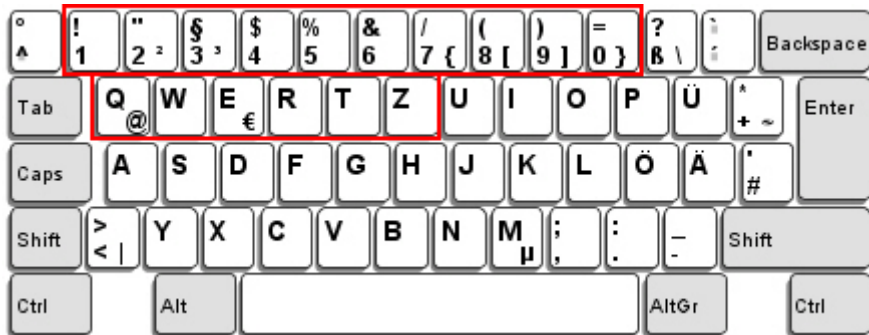

- ▶ Select “Lower Row” for the “Numeric Layout” setting for the upper row is for special characters.

NUMERIC LAYOUT

Select a proper layout that matches the alphabets layout. The RFID Reader will make adjustments according to this setting.

Options	Parameter	Description
Normal (Default)	'0'	Depend on the [Shift] key or [Shift Lock] setting.
Lower Row	'1'	For QWERTY or QWERTZ keyboard.
Upper Row	'2'	For AZERTY keyboard.

Note: This setting is to be used with the Character Substitution setting when support to certain keyboard types (languages) is unavailable but required.

CAPITAL LOCK SETTING

In order to send the alphabets with correct case, the RFID Reader needs to know the status of Caps Lock on the keyboard. Incorrect settings may result in reversed case of the alphabets being transmitted.

Options	Parameter	Description
Capital Lock OFF (Default)	'0'	Assuming that the status of Caps Lock on the keyboard is OFF, transmitted characters are exactly the same as in the tag (when "case-sensitive" is selected for Alphabets Transmission).
Capital Lock ON	'1'	Assuming that the status of Caps Lock on the keyboard is ON, transmitted characters are exactly the same as in the tag (when "case-sensitive" is selected for Alphabets Transmission). ▶ Refer to the Capital Lock Type above.
Auto Detection	'2'	The RFID Reader will automatically detect the status of Caps Lock on the keyboard before data is transmitted; transmitted characters are exactly the same as in the tag (when "case-sensitive" is selected for Alphabets Transmission).

ALPHABETS TRANSMISSION

By default, the alphabets transmission is case-sensitive, meaning that the alphabets will be transmitted according to their original case, the status of Caps Lock on the keyboard, as well as the Capital Lock setting. Select [Ignore Case] to have alphabets transmitted according to the status of Caps Lock on the keyboard only.

Options	Parameter	Description
Case Sensitive (Default)	'0'	Alphabets will be transmitted according to the original case.
Ignore Case	'1'	Alphabets will be transmitted according to the status of Caps Lock on the keyboard only.

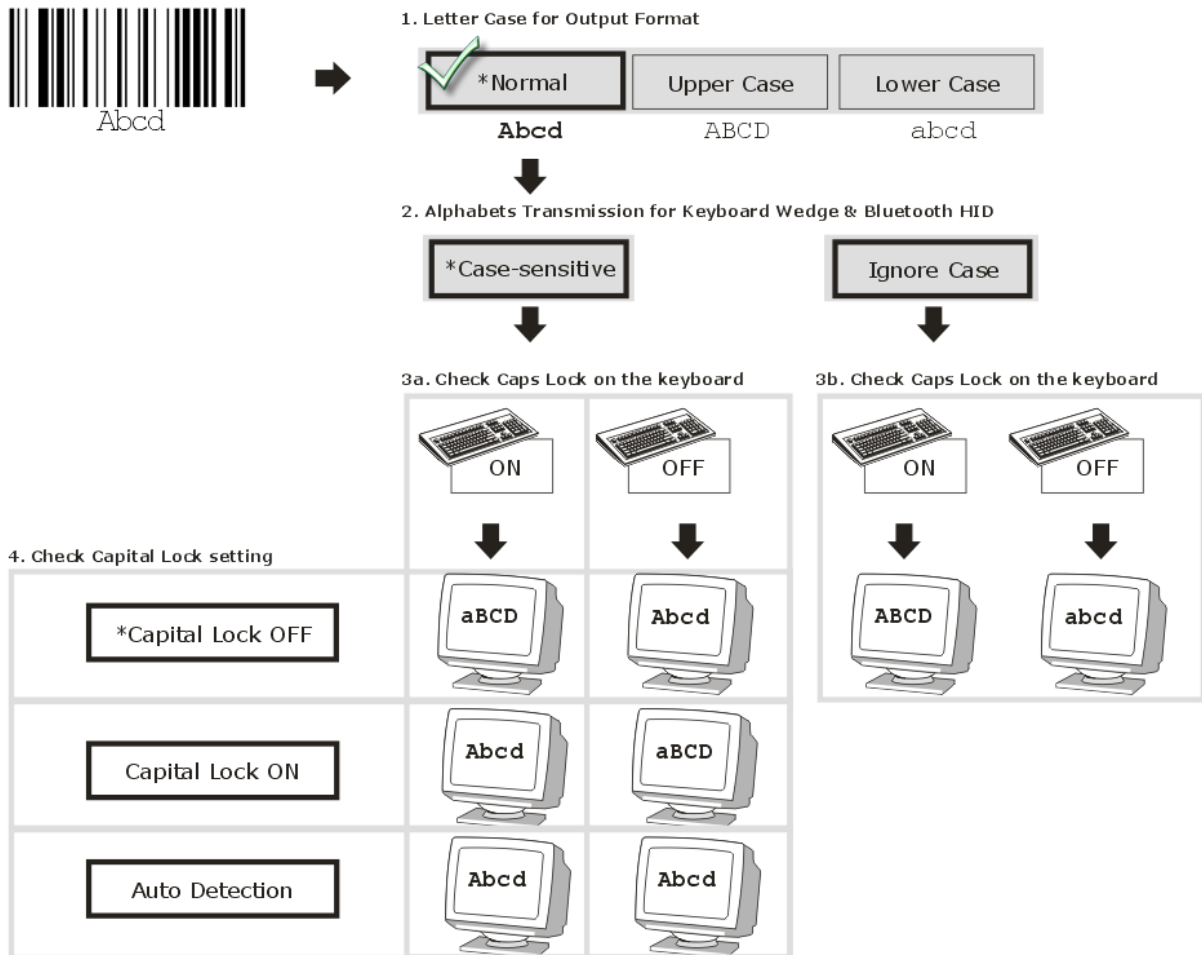

NUMERIC TRANSMISSION

By default, the alphanumeric keypad is used for transmitting numeric. Select "Numeric Keypad" if you wish to use the numeric keypad.

Options	Parameter	Description
Alphanumeric Keypad (Default)	'0'	Alphanumeric Keypad will be used for transmitting numeric.
Numeric Keypad	'1'	Numeric Keypad will be used for transmitting numeric.



2.5.3 INTER-CHARACTER DELAY

By default, the inter-character delay is set to zero. Specify a value, ranging from 0 to 254 in units of millisecond, to match the computer response time of the keyboard interface. Such delay time is inserted between every character being transmitted. The longer the delay time is, the slower the transmission speed will be.

Options	Parameter	Description
'0' (Default)	'0' ~ '254'	The range is from 0 to 254 in units of millisecond.

2.5.4 INTER-FUNCTION DELAY

By default, the inter-function delay is set to zero. Specify a value, ranging from 0 to 254 in units of milliseconds, to match the computer response time of the keyboard interface. Such delay time is inserted between every function code (0x01 ~ 0x1F) being transmitted. The longer the delay time is, the slower the transmission speed will be.

Options	Parameter	Description
'0' (Default)	'0' ~ '254'	The range is from 0 to 254 in units of millisecond.

2.5.5 HID CHARACTER TRANSMIT MODE

By default, HID interface sends data to the host in batch. You may configure the RFID Reader to "By Character" to process data one character at a time.

Options	Parameter	Description
Batch Processing (Default)	'0'	Process data by Batch.
By Character	'1'	Process data by Character

Note: "By Character" transmit mode is required when working with iPhone or iPad.

2.6 USB VCOM AND HID VIA 3610

Note: If using USB VCOM for the first time, you must install its driver beforehand. Driver version 5.4 or later is required. Please remove older versions! Refer to [2.1 USB Interface](#).

For USB VCOM and HID via 3610, connect 3610 to the USB port of host computer, and then connect RFID Reader to 3610 via *Bluetooth*[®]. Before the *Bluetooth*[®] connection between 1800 and 3610 is able to be established, users have to connect a USB cable between them to tell 1800 the information about 3610 via the "bt_target" command.

To capture the data, run any text editor on host computer. The scanned data will be transmitted to the host computer.

How to connect with the 3610?

Two parameters are necessary using "#@bt_target" command to make a connection with 3610. One is to configure connect type as 3610; and the other is serial No. of the target machine.

Command:

#@bt_target?\r

Purpose	Get <i>Bluetooth</i> [®] Target Machine
Response	OK,[m],[n]\r [m]: <i>Bluetooth</i> [®] Type, '0' – SPP Master, '1' – 3610 [n]: MACID of target Machine or S/N of 3610 ERR,[code]\r

#@bt_target=[m],[N]\r

Purpose	Set <i>Bluetooth</i> [®] Target Machine
Response	OK\r ERR,[code]\r

Example:

Command

#@bt_target=1,BS9001346 → set target to 3610 with S/N: BS9001346

Response (s)

OK

HID Settings	Defaults
Keyboard Type	PCAT (US)
Alphabets Layout	Normal
Numeric Layout	Normal
Capital Lock Type	Normal
Capital Lock State	Off
Alphabets Transmission	Case-sensitive
Numeric Transmission	Alphanumeric keypad
Inter-Character Delay	0 (ms)

2.6.1 ACTIVATE USB VCOM AND HID & SELECT KEYBOARD TYPE

When USB VCOM and HID via 3610 interface is activated, you have to select a keyboard type from parameters '097' to '110' so that you can complete this setting. Parameter '096' is for USB VCOM via 3610 connection.

USB VCOM and HID via 3610 TYPE

The following keyboard types are supported —

No.	Keyboard Type	No.	Keyboard Type
096	USB VCOM via 3610	104	3610 PCAT (Belgium)
097	3610 PCAT (US)	105	3610 PCAT (Spanish)
098	3610 PCAT (French)	106	3610 PCAT (Portuguese)
099	3610 PCAT (German)	107	3610 PS55 A01-2 (Japanese)
100	3610 PCAT (Italy)	108	Reserved
101	3610 PCAT (Swedish)	109	3610 PCAT (Turkish)
102	3610 PCAT (Norwegian)	110	3610 PCAT (Hungarian)
103	3610 PCAT (UK)		

Command:**#@bt_aclidx?\r**Purpose Get *Bluetooth*[®] 3610 Parameter Index

Response OK,[m]\r

[m]: Parameter Index

[m]	Description	Valid Parameters
'0'	3610 Type	'096' ~ '110'
'3'	Inter-function Delay	'0' ~ '254'
'4'	Inter-character Delay	'0' ~ '254'
'5'	Caps Lock State	'0' – OFF '1' – ON '2' – Auto
'7'	Alphabets Transmission	'0' – Case Sensitive '1' – Ignore Case
'8'	Digits Transmission	'0' – Alpha Numeric Keypad '1' – Numeric Keypad
'9'	Digits Position	'0' – Normal '1' – Lower Row '2' – Upper Row
'10'	Keyboard Layout	'0' – Normal '1' – AZERTY '2' – QWERTZ
'12'	HID Character Transmit Mode	'0' – Batch Processing '1' – By Character

ERR,[code]

#@bt_aclidx=[m]\rPurpose Set *Bluetooth*[®] 3610 Parameter Index

Response OK\r

ERR,[code]\r

#@bt_aclpr?\rPurpose Get *Bluetooth*[®] 3610 Parameter Value

Response OK,[m]\r

[m]: Parameter

ERR,[code]\r

#@bt_aclpr=[m]\r

Purpose Set *Bluetooth*[®] 3610 Parameter Value
Response OK\r
ERR,[code]\r

#@bt_aclact\r

Purpose Activate *Bluetooth*[®] 3610 Setting
Request #@bt_aclact\r
[m]: Parameter
Response OK\r
ERR,[code]\r

2.6.2 HID KEYBOARD SETTINGS

- ▶ Alphabets Layout
- ▶ Numeric Layout
- ▶ Capital Lock Setting
- ▶ Alphabets Transmission
- ▶ Numeric Transmission

ALPHABETS LAYOUT

By default, the alphabets layout is set to normal mode, also known as the standard English layout. Select French or German keyboard layout if necessary. RFID Reader will make adjustments when sending the "A", "Q", "W", "Z", "Y", and "M" characters according to this setting.

Options	Parameter	Description
Normal (Default)	'0'	US Keyboard Style
AZERTY	'1'	French Keyboard Style
QWERTZ	'2'	German Keyboard Style

Note: This setting only works when the keyboard type selected is US keyboard, such as PCAT (US). The Alphabets Layout and Digits Layout setting must match your keyboard.

US KEYBOARD STYLE – NORMAL

QWERTY layout, which is normally used in western countries.

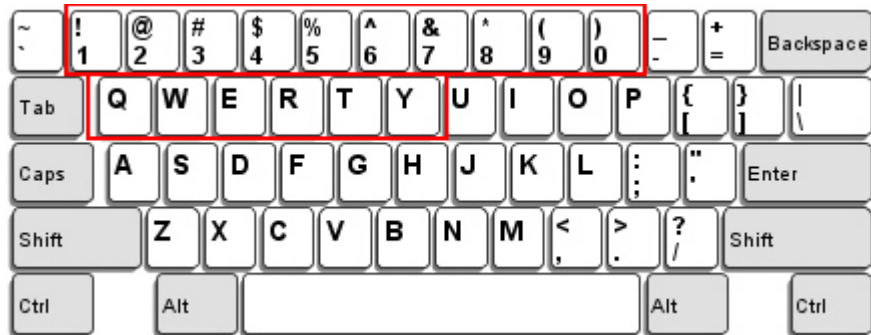

- ▶ Select “Lower Row” for the “Numeric Layout” setting for the upper row is for special characters.

FRENCH KEYBOARD STYLE – AZERTY

French layout; see below for French Keyboard Style.



- ▶ Select “Upper Row” for the “Numeric Layout” setting for the lower row is for special characters.

GERMAN KEYBOARD LAYOUT – QWERTZ

German layout; see below for German Keyboard Style.



- ▶ Select “Lower Row” for the “Numeric Layout” setting for the upper row is for special characters.

NUMERIC LAYOUT

Select a proper layout that matches the alphabets layout. RFID Reader will make adjustments according to this setting.

Options	Parameter	Description
Normal (Default)	'0'	Depends on the [Shift] key or [Shift Lock] setting
Lower Row	'1'	For QWERTY or QWERTZ keyboard
Upper Row	'2'	For AZERTY keyboard

Note: This setting is to be used with the Character Substitution setting when support to certain keyboard types (languages) is unavailable but required.

CAPITAL LOCK SETTING

In order to send the alphabets with correct case, RFID Reader needs to know the status of Caps Lock on the keyboard. Incorrect settings may result in reversed case of the alphabets being transmitted.

Status Options	Parameter	Description
Capital Lock OFF (Default)	'0'	Assuming that the status of Caps Lock on the keyboard is OFF, transmitted characters are exactly the same as in the tag (when "case-sensitive" is selected for Alphabets Transmission).
Capital Lock ON	'1'	Assuming that the status of Caps Lock on the keyboard is ON, transmitted characters are exactly the same as in the tag (when "case-sensitive" is selected for Alphabets Transmission). ▶ Refer to the Capital Lock Type above.
Auto Detection	'2'	RFID Reader will automatically detect the status of Caps Lock on the keyboard before data is transmitted; transmitted characters are exactly the same as in the tag (when "case-sensitive" is selected for Alphabets Transmission).

ALPHABETS TRANSMISSION

By default, the alphabets transmission is case-sensitive, meaning that the alphabets will be transmitted according to their original case, the status of Caps Lock on the keyboard, as well as the Capital Lock setting. Select [Ignore Case] to have alphabets transmitted according to the status of Caps Lock on the keyboard only.

Options	Parameter	Description
Case Sensitive (Default)	'0'	Alphabets will be transmitted according to the original case.
Ignore Case	'1'	Alphabets will be transmitted according to the status of Caps Lock on the keyboard only.

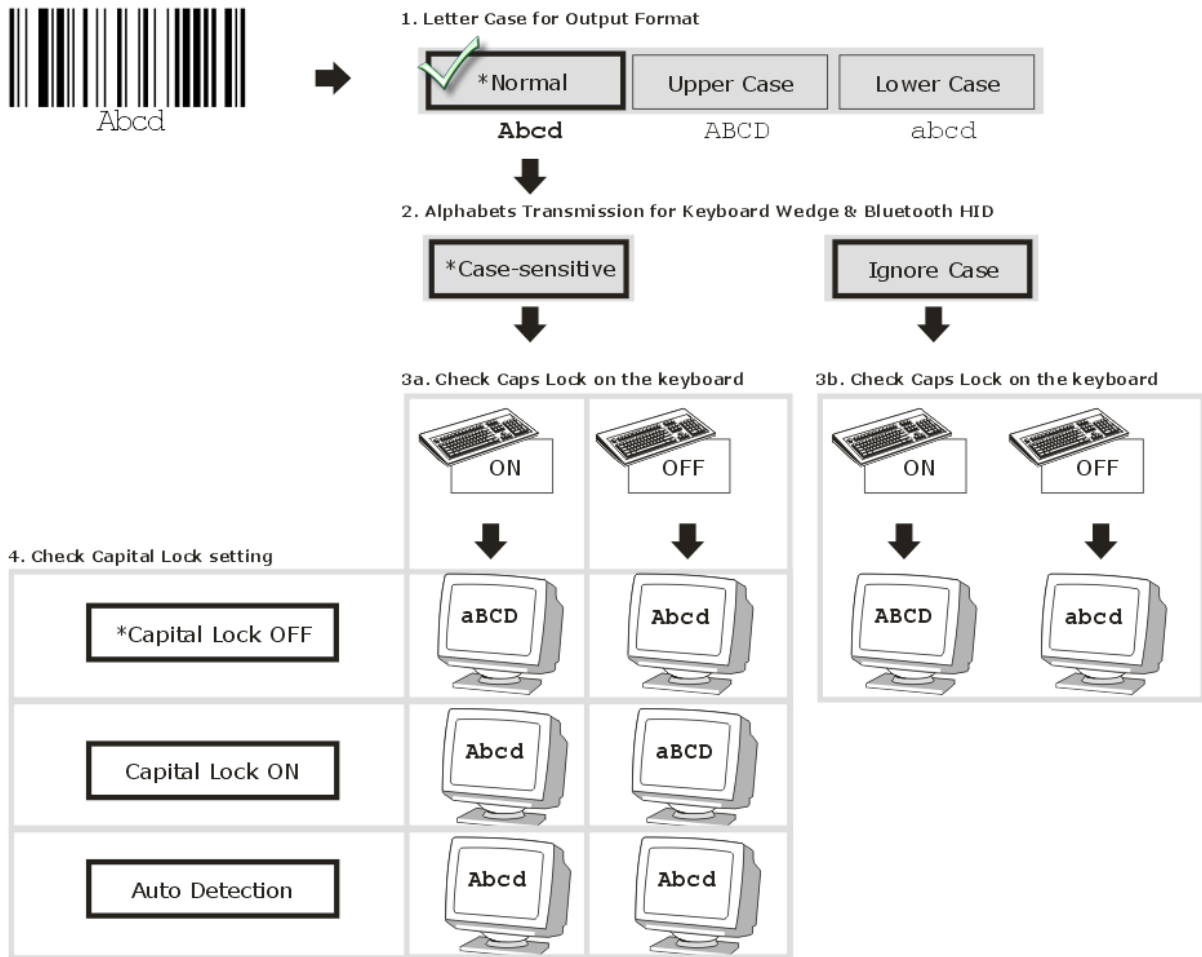

NUMERIC TRANSMISSION

By default, the alphanumeric keypad is used for transmitting digits. Select “Numeric Keypad” if you wish to use the keys on the numeric keypad.

Options	Parameter	Description
Alphanumeric Keypad (Default)	'0'	Alphanumeric Keypad will be used for transmitting numeric.
Numeric Keypad	'1'	Numeric Keypad will be used for transmitting numeric.



2.6.3 INTER-CHARACTER DELAY

By default, the inter-character delay is set to zero. Specify a value, ranging from 0 to 254 in units of millisecond, to match the computer response time of the keyboard interface. Such delay time is inserted between every character being transmitted. The longer the delay time is, the slower the transmission speed will be.

Options	Parameter	Description
'0' (Default)	'0' ~ '254'	The range is from 0 to 254 in units of millisecond.

2.6.4 INTER-FUNCTION DELAY

By default, the inter-function delay is set to zero. Specify a value, ranging from 0 to 254 in units of milliseconds, to match the computer response time of the keyboard interface. Such delay time is inserted between every function code (0x01 ~ 0x1F) being transmitted. The longer the delay time is, the slower the transmission speed will be.

Options	Parameter	Description
'0' (Default)	'0' ~ '254'	The range is from 0 to 254 in units of millisecond.

2.6.5 HID CHARACTER TRANSMIT MODE

By default, HID interface sends data to the host in batch. You may configure the RFID Reader to "By Character" to process data one character at a time.

Options	Parameter	Description
Batch Processing (Default)	'0'	Process data by Batch.
By Character	'1'	Process data by Character

Note: When connecting to an iOS-based device, this parameter must be set to '1'.

SETTING UP A WPAN CONNECTION

RFID Reader can be configured to send data to a host computer wirelessly via the *Bluetooth*[®] and 3610. Upon powering up, RFID Reader will be ready to establish a WPAN connection.

To establish a connection via *Bluetooth*[®] dongle after pairing...



Interface Option	Reference
Bluetooth [®] HID	2.5 Bluetooth[®] HID
Bluetooth [®] SPP (Slave/Master)	2.3 Bluetooth[®] SPP Slave , 2.4 Bluetooth[®] SPP Master

To establish a connection via 3610 after finishing relative configurations...



Interface Option	Reference
USB VCOM and HID via 3610	2.6 USB VCOM and HID via 3610

IN THIS CHAPTER

3.1 Connecting via <i>Bluetooth</i> [®] Dongle.....	72
3.2 Connecting via 3610.....	89
3.3 Disconnection.....	92

3.1 CONNECTING VIA *BLUETOOTH*[®] DONGLE

3.1.1 CHANGE INTERFACE

Before establishing a WPAN connection, you can configure the *Bluetooth*[®] connection interface via the USB port.

In the HyperTerminal window, issue "#@bt_type=" command to change the connected interface and issue "#@bt_type?" command to confirm the used interface at present.

- ▶ "Activate *Bluetooth*[®] HID", the parameter is '5'.
- ▶ "Activate *Bluetooth*[®] SPP Slave Mode", the parameter is '0'.
- ▶ "Activate *Bluetooth*[®] SPP Master Mode", the parameter is '3'.

For example, if you want to use SPP Slave for a connection type, see below:

Command

#@bt_type=0 → set connected interface to '0' for SPP Slave Mode

Response (s)

OK

3.1.2 CONFIGURE RELATED SETTINGS

Bluetooth Discoverable

RFID Reader can be configured to hide itself from other devices equipped with *Bluetooth*[®] wireless technology. Simply disable the device name broadcasting setting so that it won't be discovered by any other computers.

Command:

#@bt_visible?\r

Purpose	Get <i>Bluetooth</i> [®] Discoverable Status
Response	OK,[m]\r (Default m= '1')
	[m]: Discoverable
	'0' – Disable
	'1' – Enable
	ERR,[code]\r

#@bt_visible=[m]\r

Purpose	Set <i>Bluetooth</i> [®] Discoverable Property
Response	OK\r
	ERR,[code]\r

Note: By default, device name broadcasting is enabled (which is required for initial connection).

BT POWER SAVING

By default, this feature is enabled, meaning the RFID Reader will listen to the wireless network at a reduced rate.

Command:

#@bt_ps?\r

Purpose	Get <i>Bluetooth</i> [®] Power Saving
Response	OK,[m]\r (Default m= '1')
	[m]: Power Saving
	'0' – Disable
	'1' – Enable
	ERR,[code]\r

#@bt_ps=[m]\r

Purpose	Set <i>Bluetooth</i> [®] Power Saving
Response	OK\r

ERR,[code]\r

Note: When connecting more than two devices to a notebook computer with *Bluetooth*[®] wireless technology, we suggest that you disable the *Bluetooth*[®] Power Saving function for a more reliable connection.

AUTHENTICATION

When the authentication and PIN code are changed on the RFID Reader, you have to remove the RFID Reader from the paired device list (called unpairing) and go through the whole process to re-establish the connection.

Command:

#@bt_secure?\r

Purpose	Get <i>Bluetooth</i> [®] Authentication
Response	OK,[m]\r (Default m= '0')
	[m]: Authentication
	'0' – Disable
	'1' – Enable
	ERR,[code]\r

#@bt_secure=[m]\r

Purpose	Set <i>Bluetooth</i> [®] Authentication
Response	OK\r
	ERR,[code]\r

With 1800 authentication disabled, the 1800 reader can pair with multiple *Bluetooth*[®] devices. Successful pairing records will be kept for future re-connection without authentication process.

With 1800 authentication enabled, the reader can keep only one pairing record. If the reader pairs with device A and then pairs with device B, the pairing record of device B will be kept. If device A wants to connect to the reader, the pairing process must be made again.

If the pairing record on a paired device is cleared, the paired device won't be able again to pair with the reader whose authentication is enabled; to solve this problem, users are supposed to manually clear the pairing record on the reader by issuing "#@BT_RESET" command or using the function key combination.

PIN CODE

RFID Reader allows up to 16 characters for a PIN code. If the PIN or passkey is incorrect, any connection requirement will be rejected by RFID Reader. See step 8 in [3.1.3 Bluetooth[®] HID and SPP Slave](#). By default, the PIN code value is "0000".

Command:

#@bt_pin?\r

Purpose Get Bluetooth® PIN Code

Response OK,[m],[n]\r (Default m= '0000', n= '4')

[m]: length of PIN '0' ~ '16', '0' means no PIN

[n]: PIN, 1~16 characters, only exists when [m]! = '0' (m≠0)

ERR,[code]\r

#@bt_pin=[m],[n]\r

Purpose Set *Bluetooth*® PIN Code

Response OK\r

ERR,[code]\r

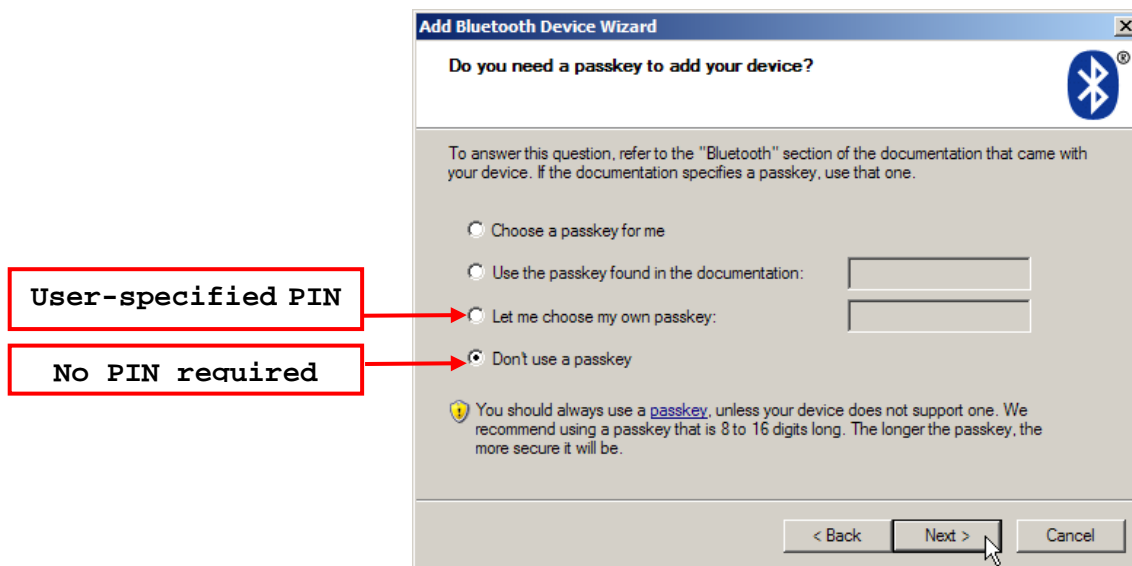

Note: When using *Bluetooth*® HID, some device driver may not support pre-defined PIN code for authentication. In this case, make sure you have the RFID Reader set to "No PIN required" or "User-specified PIN" before pairing. While pairing, the host PIN code will be displayed on the host computer. Have the RFID Reader to input the matching PIN code for connection. Refer to [1.3.2 Bluetooth® Pairing Mode](#).

SSP (Secure Simple Pairing)

Command:

#@bt_ssp?\r

Purpose	Get <i>Bluetooth</i> [®] SSP Status
Response	OK,[m]\r [m]: SSP Mode '0' – Disable '1' – Enable (Default) ERR, [code]\r

#@bt_ssp=[m]\r

Purpose	Enable/Disable <i>Bluetooth</i> [®] SSP
Response	OK\r ERR,[code]\r

Note: SSP feature is available only for iOS-based devices currently. We suggest it is better to enable SSP function when using an iOS-based device.

Bluetooth Auto Reconnection

Command:

#@bt_recon?\r

Purpose	Get <i>Bluetooth</i> [®] Auto Reconnection Status
Response	OK,[m]\r [m]: Auto reconnection function '0' – Disable '1' – Enable (Default) ERR, [code]\r

#@bt_recon=[m]\r

Purpose	Enable/Disable <i>Bluetooth</i> [®] Auto Reconnection
Response	OK\r ERR,[code]\r

Note: It's recommended to disable the auto reconnection feature while the scanner works with a Windows CE or Windows Mobile device.

3.1.3 BLUETOOTH® HID AND SPP SLAVE

The procedure goes through associating devices for establishing a WPAN connection, which is pretty much the same except for the software you are using. If your computer is running Microsoft® Windows® XP (SP1 to SP3), Windows Vista® Service Pack 1 (SP1) and Windows 7, you can use the software support that Windows® includes, or you can use the driver that the device manufacturer provides. Now, let's try using the software support that Windows® XP Service Pack 2 includes.

BLUETOOTH® HID

By default, the keyboard type of *Bluetooth*® HID is set to PCAT (US). When *Bluetooth*® HID is re-activated, you have to select a keyboard type to complete this setting. Refer to [2.5.1 Activate Bluetooth® HID & Select Keyboard Type](#).

Refer to steps 1~11 below for a *Bluetooth*® connection.

BLUETOOTH® SPP SLAVE

- 1) Enable the *Bluetooth*® function on host computer. (Windows® XP only)
- 2) Double-click the *Bluetooth*® icon located on the lower right of the taskbar.  14:14 PM
Alternatively, you may go to **Control Panel** > **Bluetooth Devices**.
- 3) Click [Add] to search devices nearby.

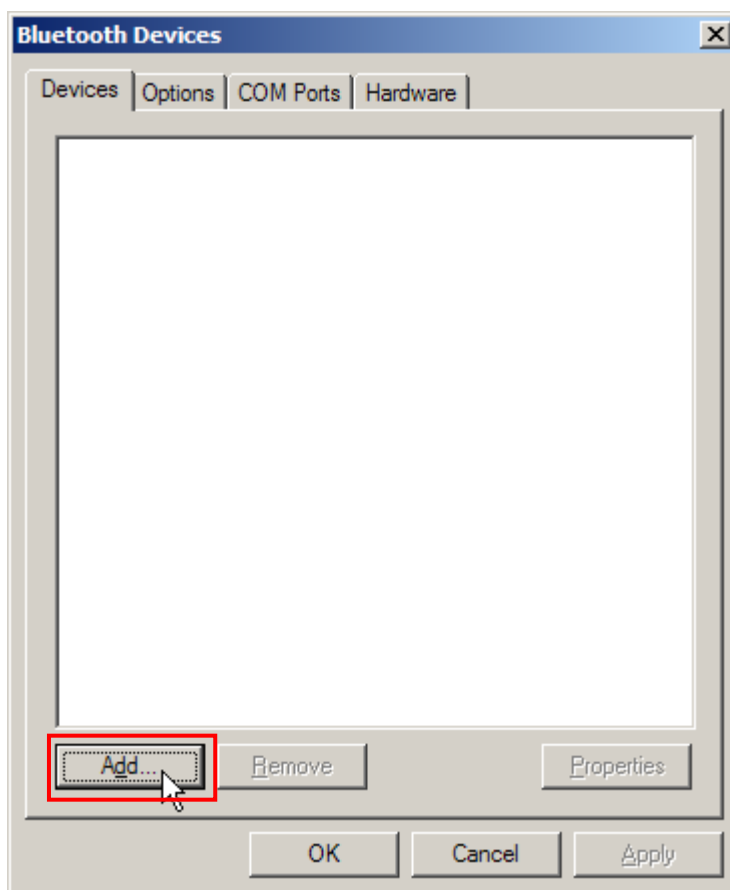

- 4) Turn on RFID Reader with correct WPAN settings, such as select *Bluetooth*[®] SPP Slave or HID, broadcasting enabled, authentication enabled, and PIN code specified, etc if you want to use a passkey. Select "My device is set up and ready to be found" check box on the "Add *Bluetooth*[®] Device Wizard" window.
- 5) Click [Next].

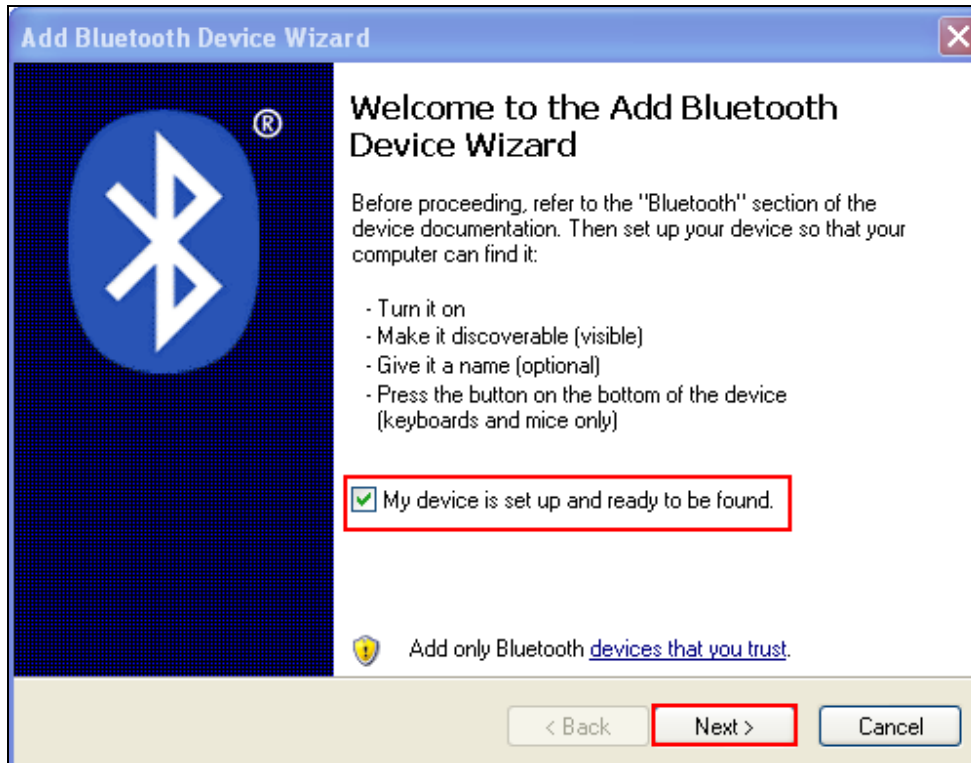

- 6) Wait for a few seconds for the Wizard to search available devices nearby.
All available devices will appear on the search window. Select the device (e.g. RFID Reader) that you want to connect.
If the target device does not appear on the list, click [Search Again] to refresh the list. The RFID Reader might enter power-saving mode during an idling time (=discoverable), and you can press the <Trigger> to have it active again. It will then stay active for a specified period of time (2 minutes by default) and wait for the host computer to establish a connection.

- 7) See SPP Slave connection below, click [Next].

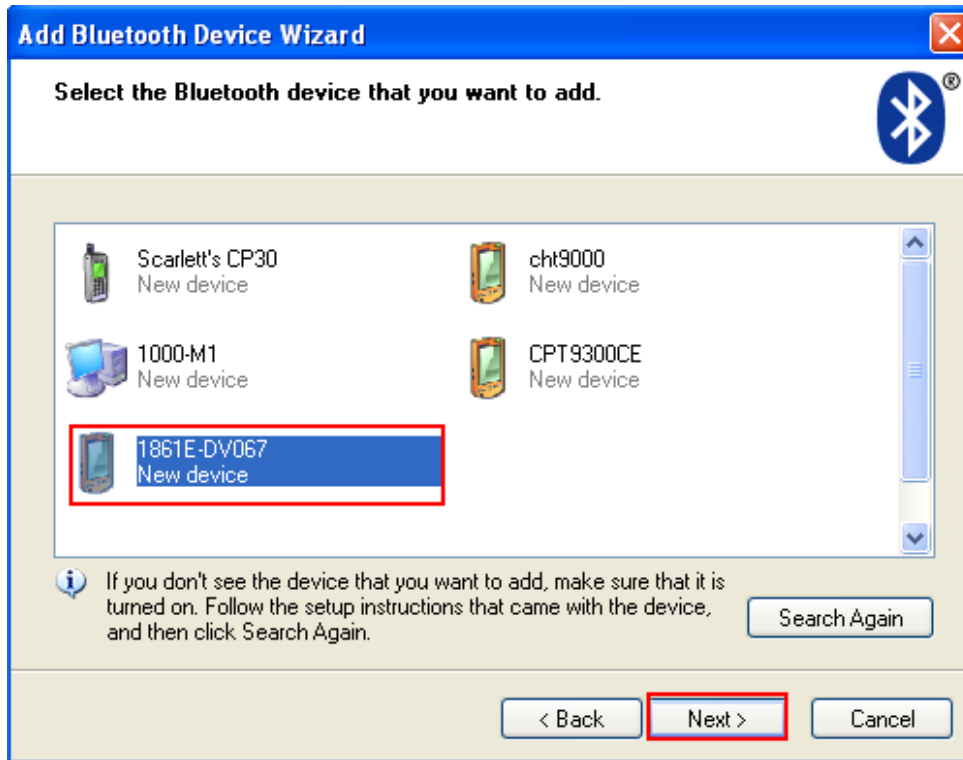

- See BT HID connection below, click [Next].

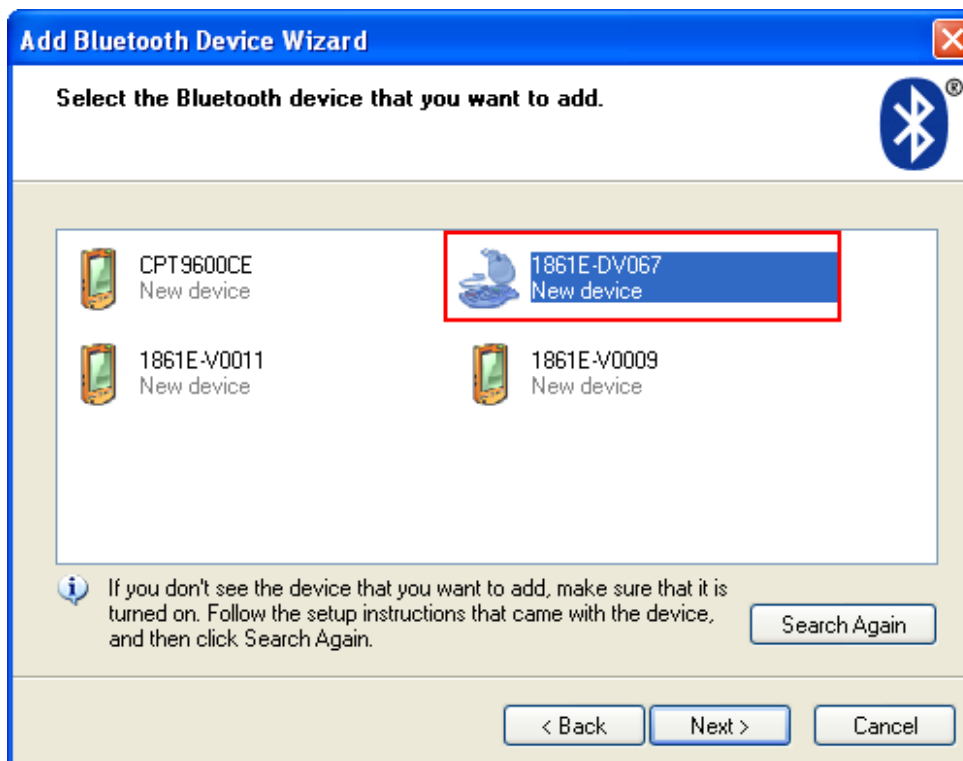

- 8) Enter the passkey for authentication, which must be exactly the same as configured for RFID Reader. Click [Next].

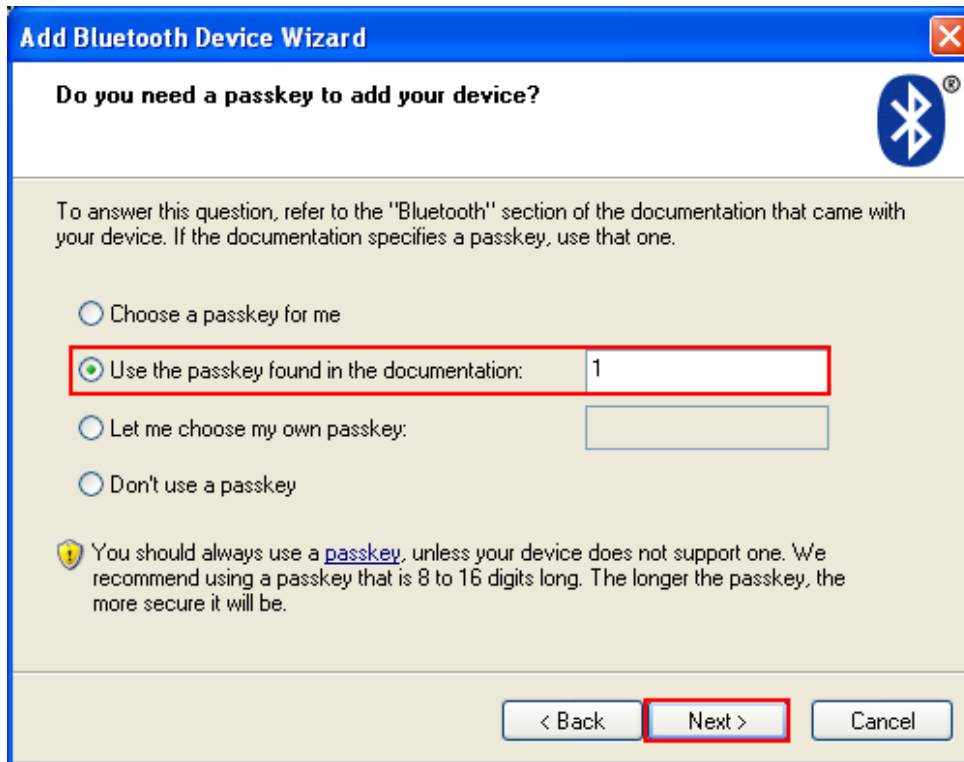

- 9) Wait for a few seconds for Windows to confirm the Passkey.

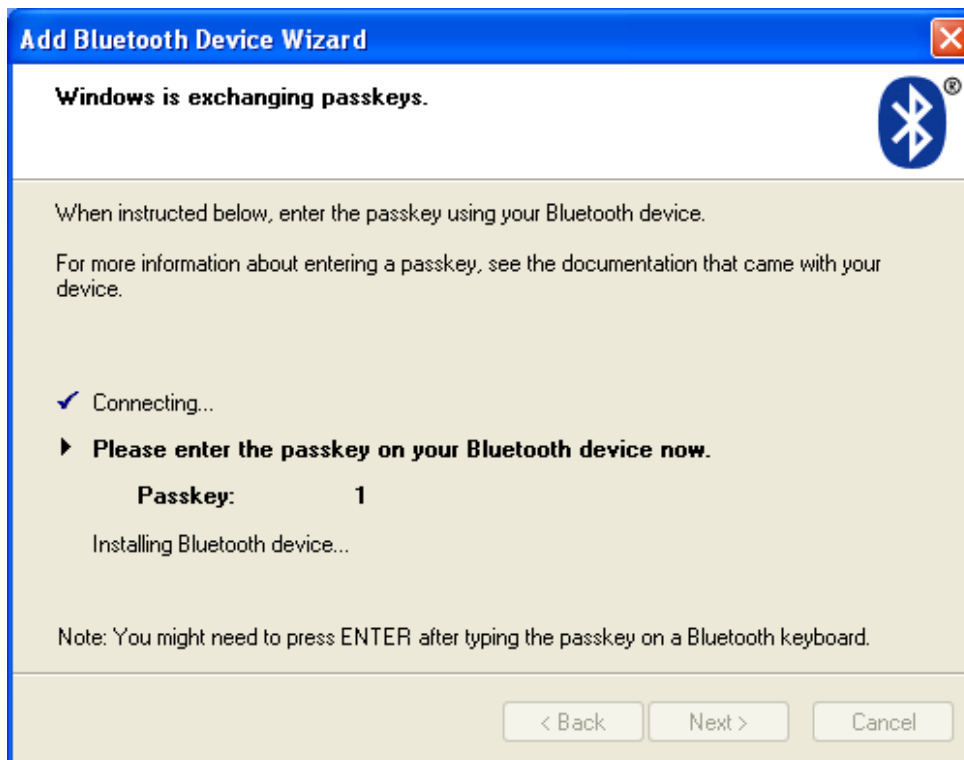

- 10) See SPP Slave connection below, click [Finish].

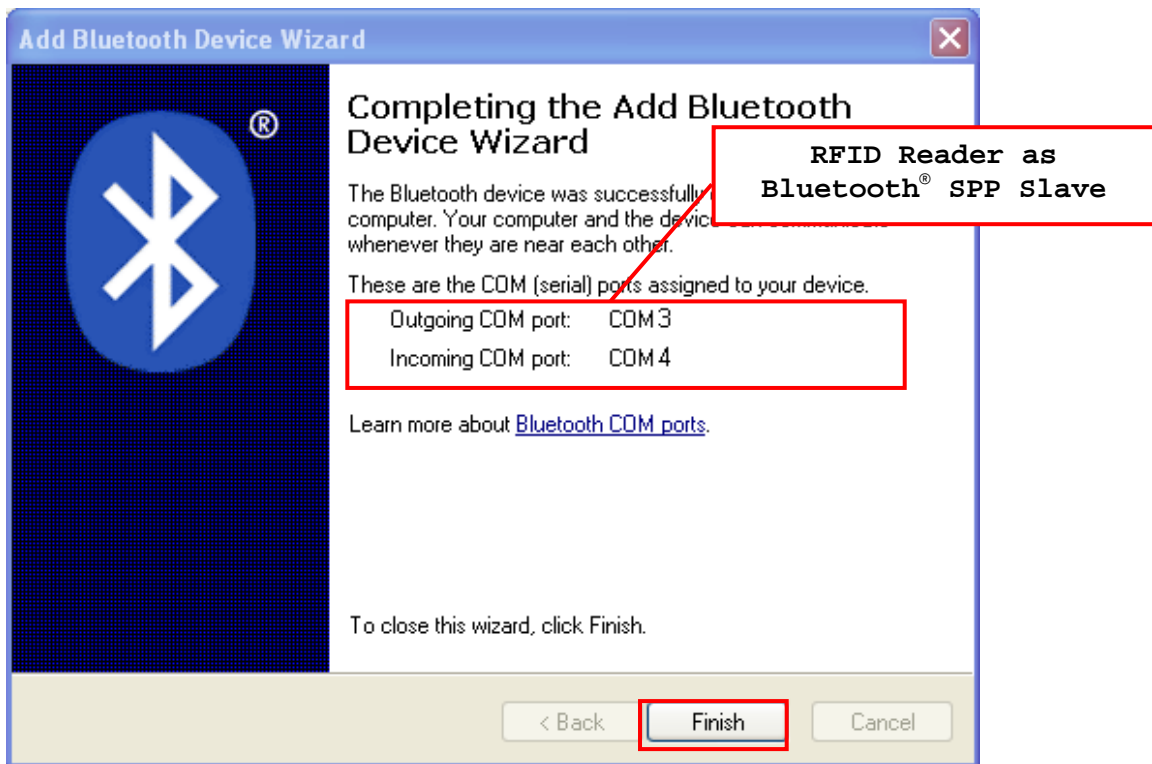

- See BT HID connection below, click [Finish].

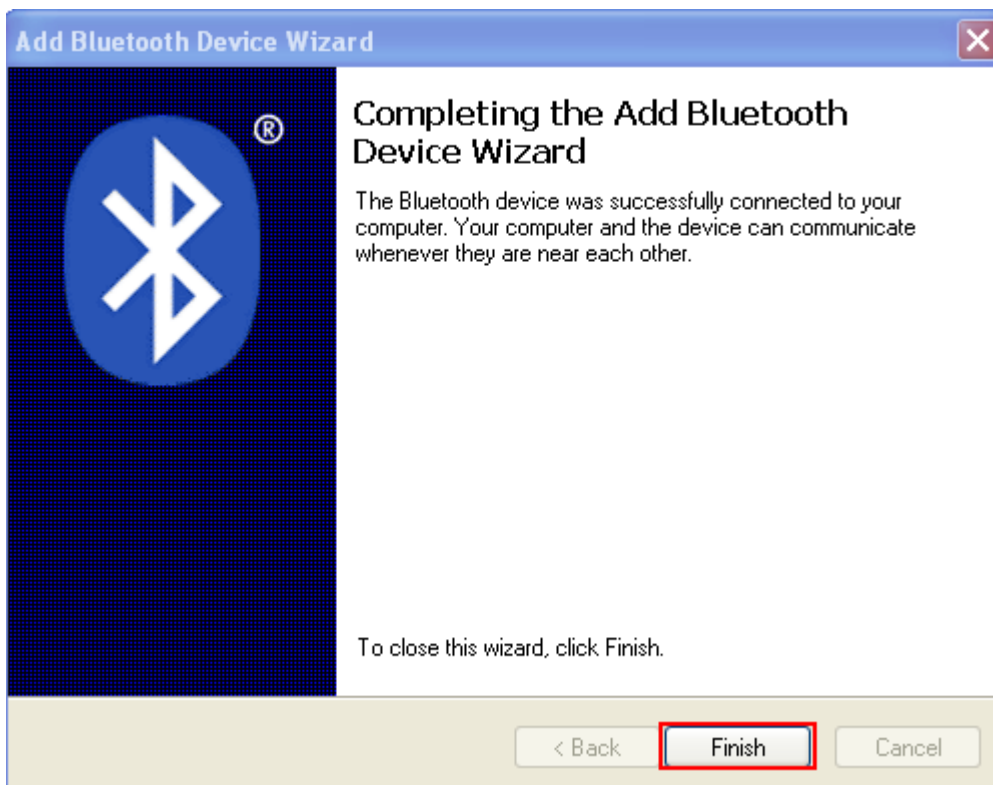

Note: When *Bluetooth*[®] security is enabled without providing a pre-set PIN code, the random PIN code is supported.

11) Now the RFID Reader will be listed as shown below.

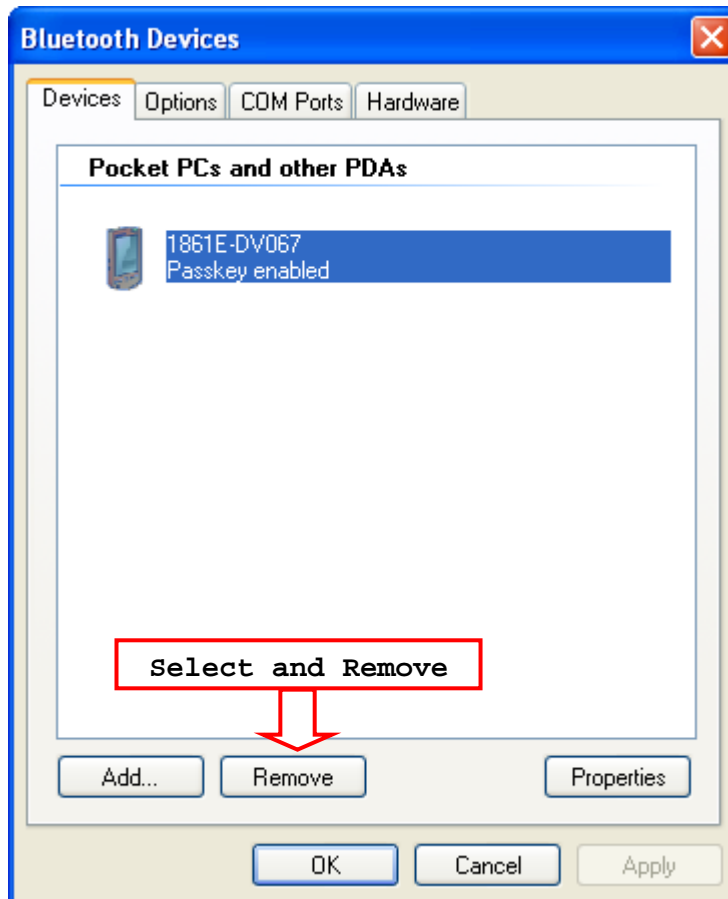

Note: When any changes are made to authentication and PIN code on the RFID Reader, or you want to change RFID Reader to use *Bluetooth*[®] HID, it is suggested to remove the connected RFID Reader from the paired device list (called unpairing) first and go through the whole process to re-establish the connection.

12) Run the desired application on your computer, such as HyperTerminal.exe if using *Bluetooth*[®] SPP or Notepad.exe if using *Bluetooth*[®] HID.

Once the desired application is configured completely, the status of the RFID Reader listed on the device list will be shown as "Connected", indicating the WPAN connection is established successfully via the outgoing COM port if using *Bluetooth*[®] SPP Slave.

Note: Even though the RFID Reader is connected to the host with authentication disabled (= no PIN code required), the host may still request a PIN code while the application is opening COM port. A random PIN code is supported so that you can input a matching PIN code on the RFID Reader. Refer to [3.1.2 Configure Related Settings](#).

See the comparisons between *Bluetooth*[®] SPP and HyperTerminal below, for HyperTerminal configurations; refer to [Using HyperTerminal](#).

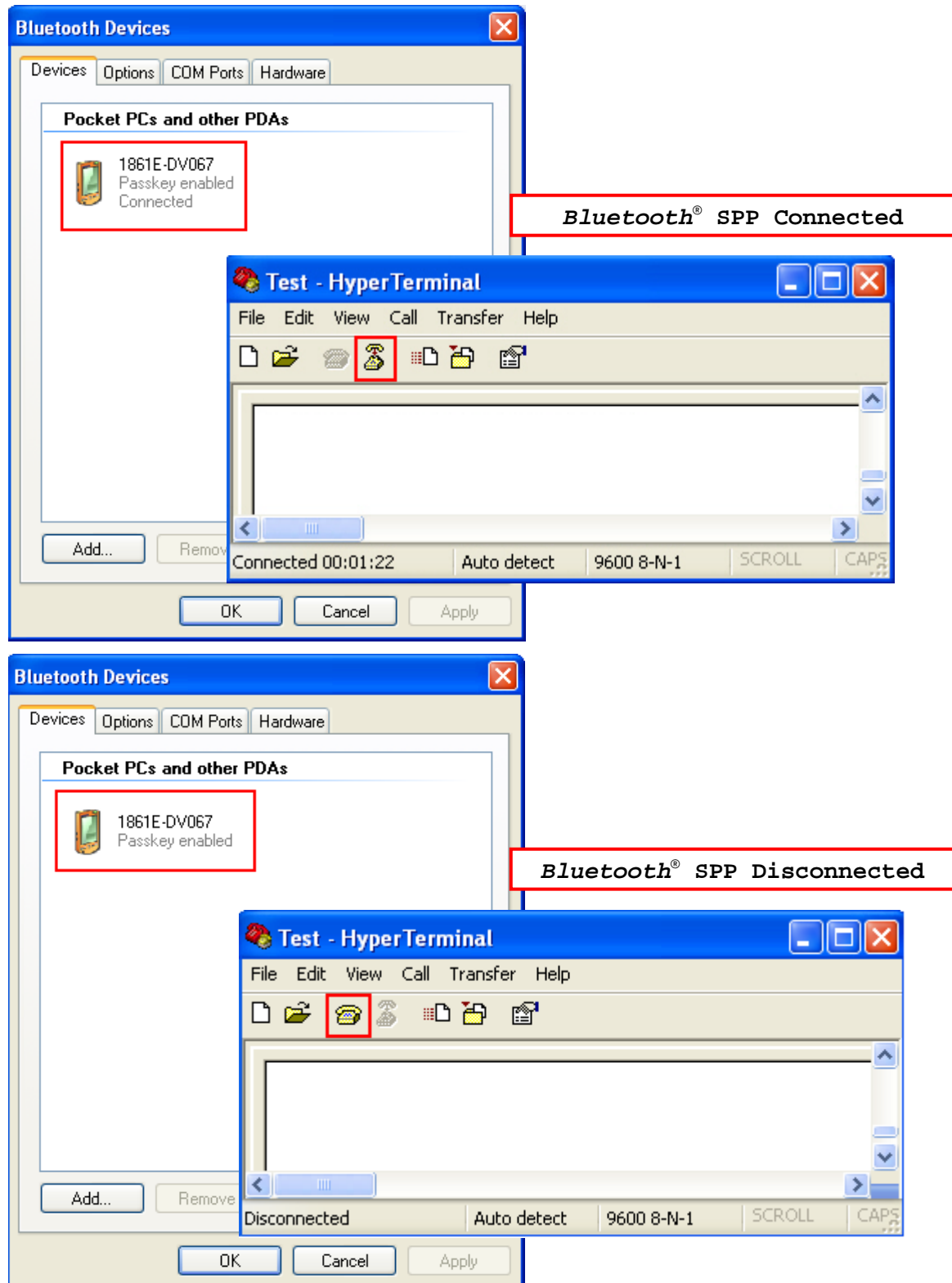

See the comparisons between *Bluetooth*[®] HID and Notepad below:

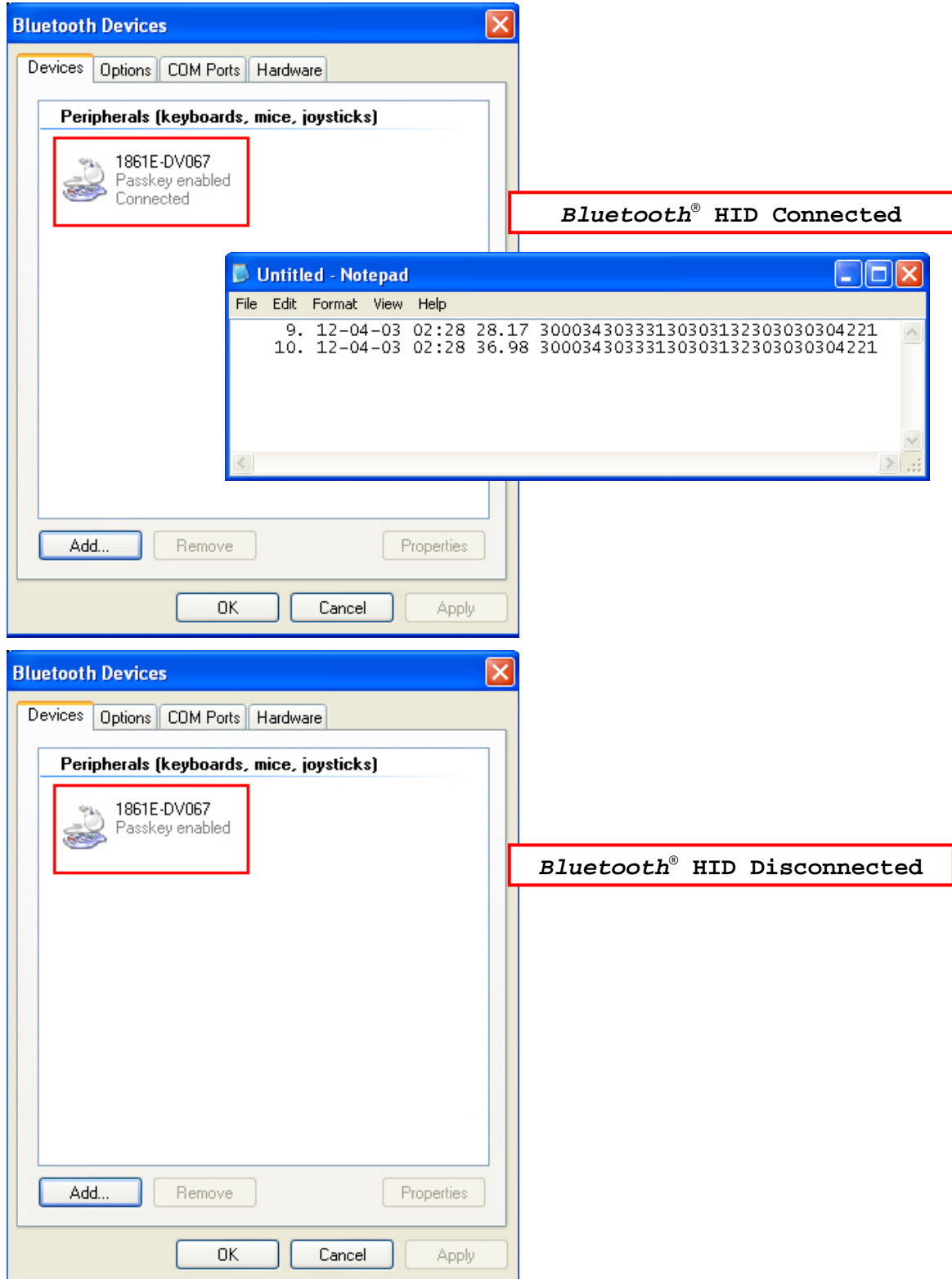

3.1.4 BLUETOOTH® SPP MASTER

BLUETOOTH® SPP MASTER

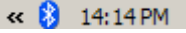
- 1) Enable the *Bluetooth*® function on the host computer.
- 2) Double-click the *Bluetooth*® icon located on the lower right of the taskbar.  Alternatively, you may go to **Control Panel** > **Bluetooth Devices**.
- 3) Select Hardware tab and click [Properties].

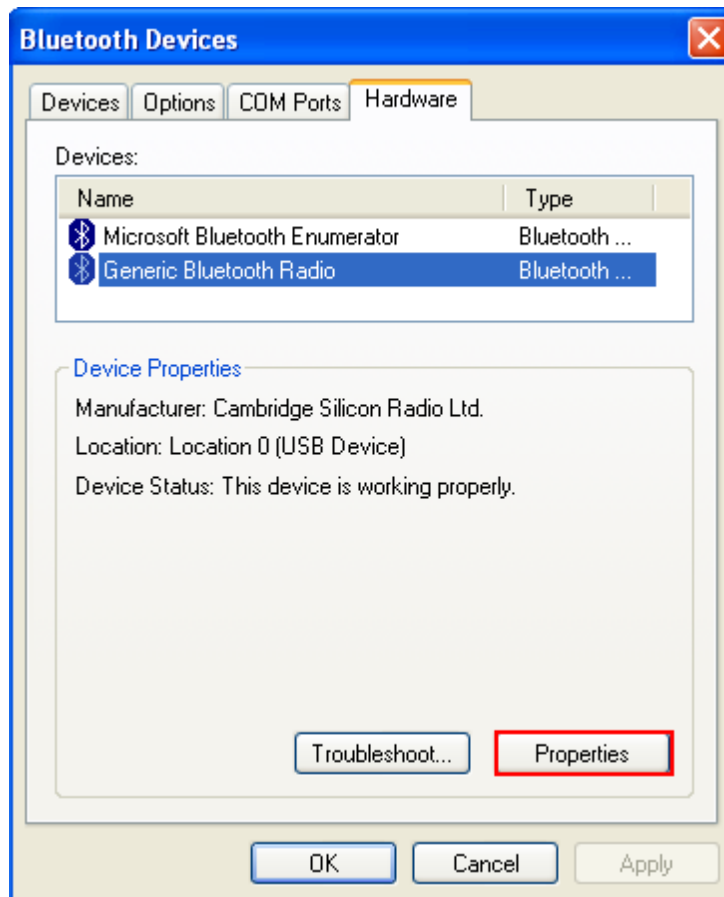

- 4) In the Generic *Bluetooth*[®] Radio Properties window, select Advanced tab to see the *Bluetooth*[®] MACID of host computer.

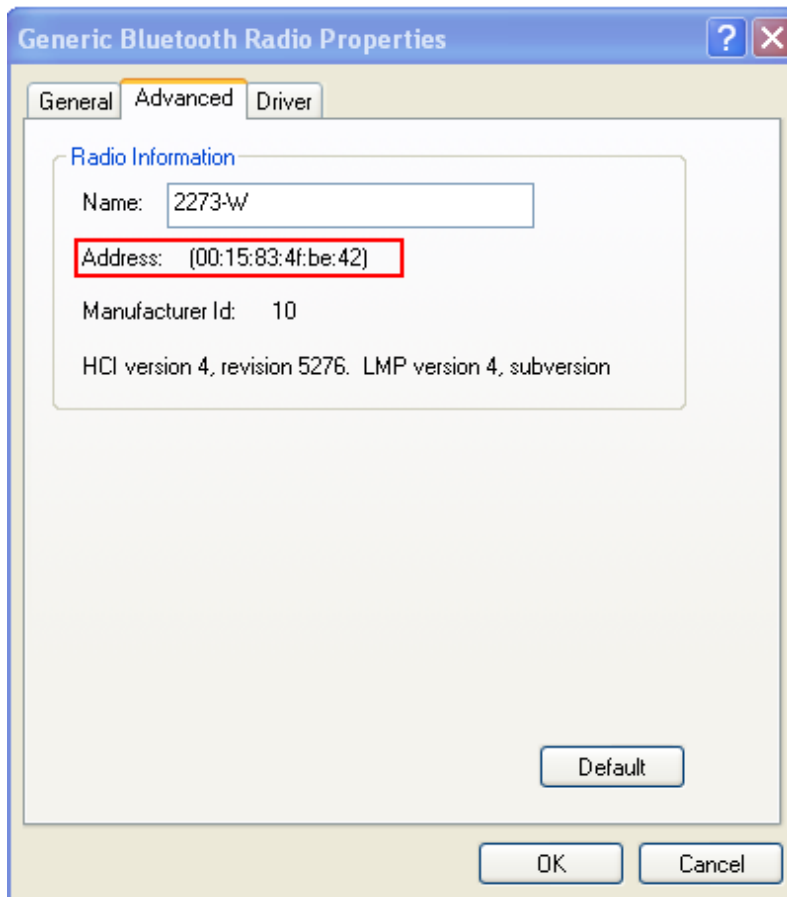

- 5) Enable HyperTerminal on the host computer and configure the variables required for *Bluetooth*[®] SPP Master connection.

Command
#@bt_target=0,0015834fbe42 → configure the type and MACID of connected device
Response (s)
OK

Note: When any changes are made to *Bluetooth*[®] type, it is suggested to reset the *Bluetooth*[®] connection by "#@bt_reset" command. Refer to [3.3.2 Reset a Connection](#).

- 6) On the host computer, a *Bluetooth*[®] connection information box will pop-up on the lower right of the taskbar. Click it.

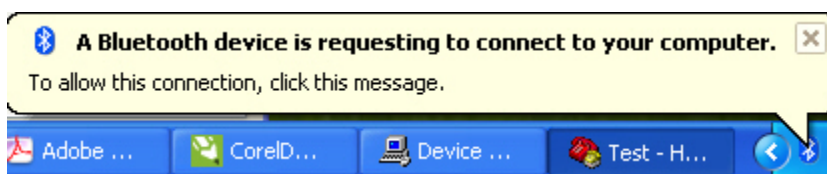

- 7) In the Add *Bluetooth*[®] Device Wizard window, key in the passkey that is the same as you have entered on the RFID Reader. The default value is 0000. Click [Next].

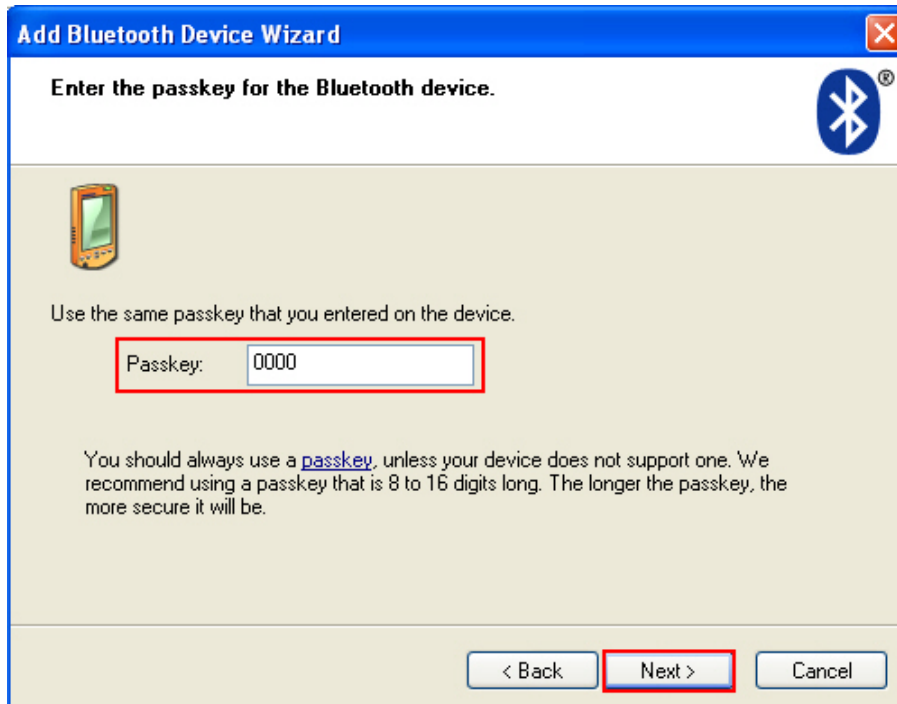

- 8) Click [Finish].

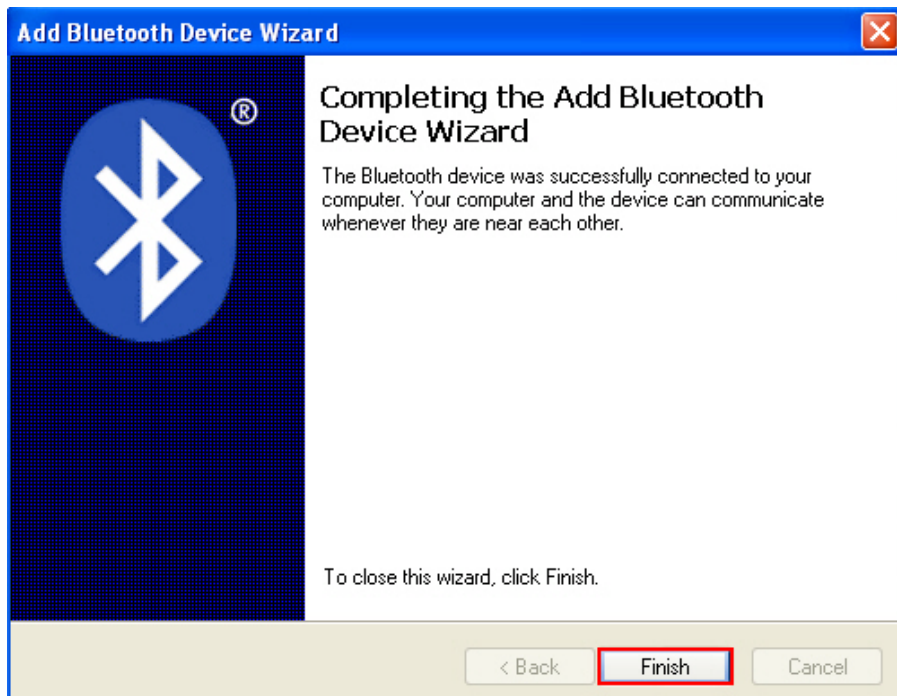

- 9) In the *Bluetooth*[®] Devices configured window will show you connected Device.

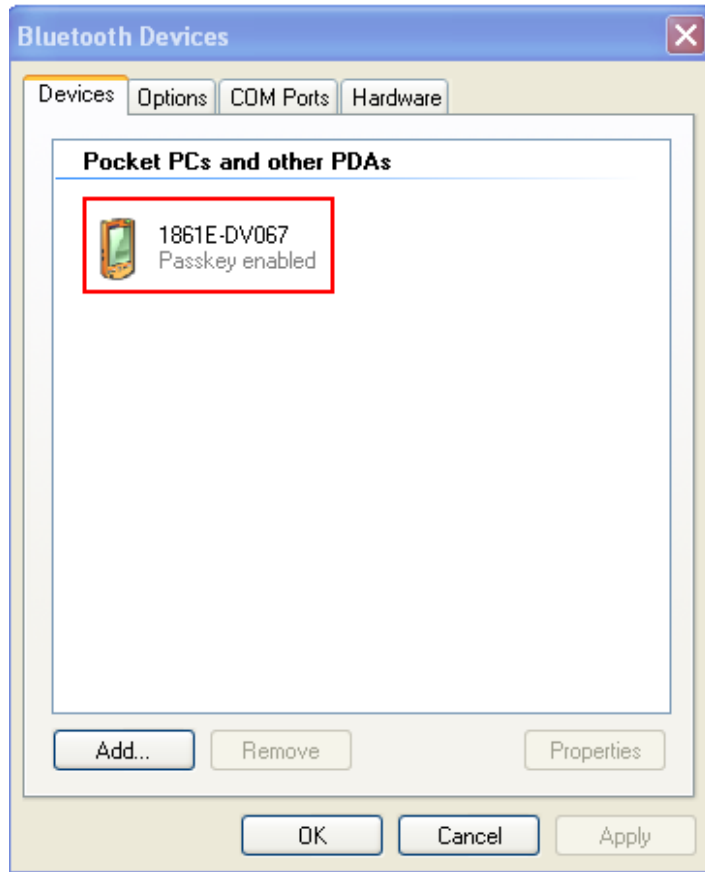

Note: When any changes are made to authentication and PIN code on the RFID Reader, or you want to change to use *Bluetooth*[®] HID, it is suggested to remove the connected RFID Reader from the paired device list (called unpairing) first and go through the whole process to re-establish the connection.

- 10) Run the desired application on host computer, such as HyperTerminal.exe if using *Bluetooth*[®] SPP or Notepad.exe if using *Bluetooth*[®] HID.

Once the desired application is configured completely, the status of the RFID Reader listed on the device list will be showed as "Connected", indicating the WPAN connection is established successfully.

3.2 CONNECTING VIA 3610

3.2.1 CONNECT TO 3610

To configure 3610 connection parameters, the RFID reader must have established a *Bluetooth*[®] connection with 3610. Thus please carry out `"#@bt_target=1,xxxxxxxx\r"` command to establish the connection between them. Once connected, the RFID Reader will respond with three beeps (tone ascending from low to high), and the LED2 flashes blue (On/Off ratio 0.02 s: 3 s). When out of range, the RFID Reader will respond with three short beeps (tone descending from high to low).

3.2.2 USB HID VIA 3610 CONNECTION

If you want to change the USB HID via 3610 interface, use one of the connected RFID Reader to configure the interface-related settings and it will pass the new settings to 3610, which will then initialize and pass the settings to any other connected device.

- 1) Power on RFID Reader.
- 2) Connect RFID Reader to host computer with a USB cable.
- 3) Enable HyperTerminal on the host computer for issuing commands.
- 4) Follow [Using HyperTerminal](#) to make a USB connection between the host computer and RFID Reader.
- 5) Follow [2.6 USB VCOM and HID via 3610](#) to connect 3610 to the USB port of host computer. And then make a connection between RFID Reader and 3610.
- 6) After the connection between RFID Reader and 3610 is established, configure related settings as below.

Command

#@bt_aclidx=0 → enter 3610 type configuration

Response (s)

OK

Command

#@bt_aclpr=97 → set to 3610 PCAT US

Response (s)

OK

Command

#@bt_aclidx=4 → enter inter-character delay setting

Response (s)

OK

Command

#@bt_aclpr=10 → set keyboard inter-character delay time to 10ms

Response (s)

OK

Command

#@bt_aclact → activate the settings

Response (s)

OK

- 7) After the “#@bt_aclact” command is performed, the connection between RFID Reader and 3610 will disconnect for a while. Once the connection resumes, the interface of 3610 is updated to USB HID.
- 8) For USB HID via 3610 connection, you can capture the data by running any text editor, e.g. Notepad on host computer.
- 9) Once the connection is successful, the scanned data will be transmitted to the Notepad.

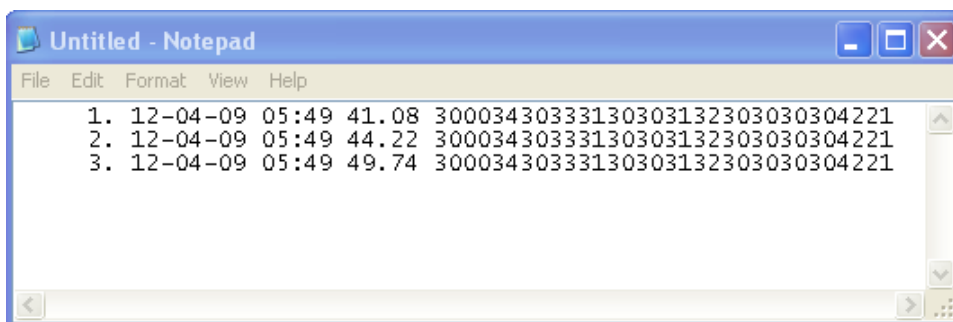

3.2.3 USB VCOM VIA 3610 CONNECTION

If you want to change the USB VCOM via 3610 interface, use one of the connected RFID Reader to configure the interface-related settings and it will pass the new settings to 3610, which will then initialize and pass the settings to any other connected devices.

- 1) Power on RFID Reader
- 2) Connect RFID Reader to host computer with a USB cable.
- 3) Enable HyperTerminal on the host computer for issuing commands.
- 4) Follow [Using HyperTerminal](#) to make a USB connection between the host computer and RFID Reader.
- 5) Before using USB VCOM via 3610, you need to install USB VCOM driver. Follow [2.6 USB VCOM and HID via 3610](#) to connect 3610 to the USB port of host computer. And then make a connection between RFID Reader and 3610.
- 6) After the connection between RFID Reader and 3610 is established, configure related settings as below.

Command

#@bt_aclidx=0 → enter 3610 type configuration

Response (s)

OK

Command

#@bt_aclpr=96 → set to 3610 VCOM

Response (s)

OK

Command

#@bt_aclact → activate the settings

Response (s)

OK

- 7) After the “#@bt_aclact” command is performed, the connection between RFID Reader and 3610 will disconnect for a while. Once the connection resumes, the interface of 3610 is updated to Virtual COM.
- 8) Then 3610 will pass the settings to other connected devices.

3.3 DISCONNECTION

You can follow the methods below to break a connection between RFID Reader and host computer:

- 1) Issue "#@bt_disc" to disconnect from current connected device.
- 2) Issue "#@bt_type" to change the connection type. Current connection will be broken.
- 3) Issue "#@bt_reset" to clear the information of remote device. Current connection will be broken and connection type will resume to SPP slave.
- 4) Use Function key to break the connection, refer to [1.4.2 Function Key](#).

3.3.1 BREAK A CONNECTION

You can force the RFID Reader to break a *Bluetooth*[®] connection with host computer by issuing command.

Command:

#@bt_disc\r

Purpose Break Current *Bluetooth*[®] Connection

Response OK\r

ERR,[code]\r

Note: The issues below will also result in disconnection:

- 1) Entering power saving mode, refer to [1.1.3 Power Saving Mode](#).
- 2) System power off automatically, refer to [1.1.2 Power OFF](#).
- 3) Disconnection requirement from the connected device.

3.3.2 RESET A CONNECTION

Perform the "#@bt_reset" command to clear the current pairing record and restore the connection type to default SPP Slave. Then go through the whole process in [Setting Up a WPAN Connection](#) to establish a new connection.

Command:

#@bt_reset\r

Purpose Reset *Bluetooth*[®] Connection

Response OK\r

ERR,[code]\r

SCANNING UHF RFID TAG

Equipped with a switch in the handle, the RFID Reader allows you to toggle between RFID and Alternate modes. Make sure the switch is well-positioned before taking on RFID scanning tasks. You can also get the status between RFID and Alternate modes by issuing the “#@rf_switch?” command.

Command:

#@rf_switch?\r

Purpose	Get the Status between RFID and Alternate Mode
Response	OK,[m]\r (Default m= '1') [m]: Status of RFID/EXT Switch '0' – EXT Mode (Alternate Mode) '1' – RFID Mode ERR,[code]\r

IN THIS CHAPTER

4.1 Scan Mode	94
4.2 Scan Time.....	96
4.3 Filter	98
4.4 Multi-Tag	110
4.5 Access Tag	114
4.6 Advanced Settings	121

4.1 SCAN MODE

RFID Reader scan modes are divided into Single, Multi-Tag and Test Modes. These are described below.

Scan Mode	Description	
Single Mode	<p>Read Tag by pressing <Trigger> key.</p> <ol style="list-style-type: none"> Condition to start the operation: Press and hold the <Trigger> key. Condition to stop the operation: <ol style="list-style-type: none"> A tag is read <Trigger> key is released. "Scan Session Timeout" expires while no Tag data is received New scan mode is set. Release <Trigger> key and press it again to start a new operation cycle. Scanning Timeout will be refreshed. 	
Multi-Tag Mode	Multi-Tag counter=0	<p>Press and hold the <Trigger> key to read Tag continuously. Repeated Tags will be accepted.</p> <ol style="list-style-type: none"> Conditions to start the operation: Press and hold the <Trigger> key. Conditions to stop the operation: <ol style="list-style-type: none"> <Trigger> key is released. New scan mode is set. Scanning speed is controlled by Scanning Delay.
	Multi-Tag counter≠0	<p>Press and hold the <Trigger> key to read Tag continuously. Repeated Tags will be ignored and new tag's EPC will be recorded, then counter is increased.</p> <ol style="list-style-type: none"> Conditions to start/continue the operation: Press and hold the <Trigger> key. Conditions to suspend the operation: <ol style="list-style-type: none"> Release <Trigger> key. Conditions to stop the operation: <ol style="list-style-type: none"> The number of new tags recorded is equal to Multi-Tag counter. New Multi-Tag Counter is set. New scan mode is set. The counter of read tag can be reset by command and function key. Scanning speed is controlled by Scanning Delay.
Test Mode	<p>Read Tag continuously without pressing the <Trigger>. Capable of decoding the same tag repeatedly for testing purpose.</p> <ol style="list-style-type: none"> Conditions to start the operation: Scan mode is set to "Test mode" Conditions to stop the operation: New scan mode is set. Scan Session Timeout, Scanning Delay, Multi-Tag Counter and EPC filter parameters have no effect in this mode. 	

	4. If RFID Function=Write Tag Memory, the RFID Reader can not be set to Test Mode.
--	--

Command:**#@rf_scan?\r**

Purpose	Get Scan Mode
Response	OK,[m]\r (Default m= '6') [m]: Scan Mode '6' – Single Mode '7' – Test Mode '9' – Multi – Tag Mode, refer to 4.4 Multi-Tag . ERR,[code]\r

#@rf_scan=[m]\r

Purpose	Set Scan Mode
Response	OK\r ERR,[code]\r

4.2 SCAN TIME

4.2.1 TIMEOUT

You have to specify the scanning timeout interval (0~254 sec.; 0= Disable) when the scan mode is set to Single Mode.

- ▶ Operation will stop if the operation time = Scan Session Timeout and No Tag data is received.
- ▶ The range of timeout is 0~254 second. By default the value is set to '0' to disable scanning timeout.

Command:

#@rf_tscan?\r

Purpose	Get Scan Session Timeout
Response	OK,[m]\r (Default m= '0')
	[m]: Timeout, '0' ~ '254'
	ERR,[code]\r

#@rf_tscan=[m]\r

Purpose	Set Scan Section Timeout
Response	OK\r
	ERR,[code]\r

Note: This command is available for Single Mode. For example, if you set the "#@rf_tscan" value to 5, the waiting time is set to 5 sec. upon pressing the trigger. If no tag is scanned within that period, the operation will stop.

4.2.2 DELAY TIME

You can specify the scanning delay time when the scan mode is set to Multi-Tag Mode.

Command:

#@rf_scandy?\r

Purpose Get Scan Delay

Response OK,[m]\r (Default m= '1')

[m]: Scan Delay

'0'	25ms (for 1862 only; applicable to Q>3)
'1'	50ms (default)
'2'	100ms
'3'	250ms
'4'	500ms
'7'	10ms (for 1862 only; applicable to Q>3)

ERR,[code]\r

#@rf_scandy=[m]\r

Purpose Set Scan Delay

Response OK\r

ERR,[code]\r

4.3 FILTER

The Flow Chart below is the procedure of scanning tags:

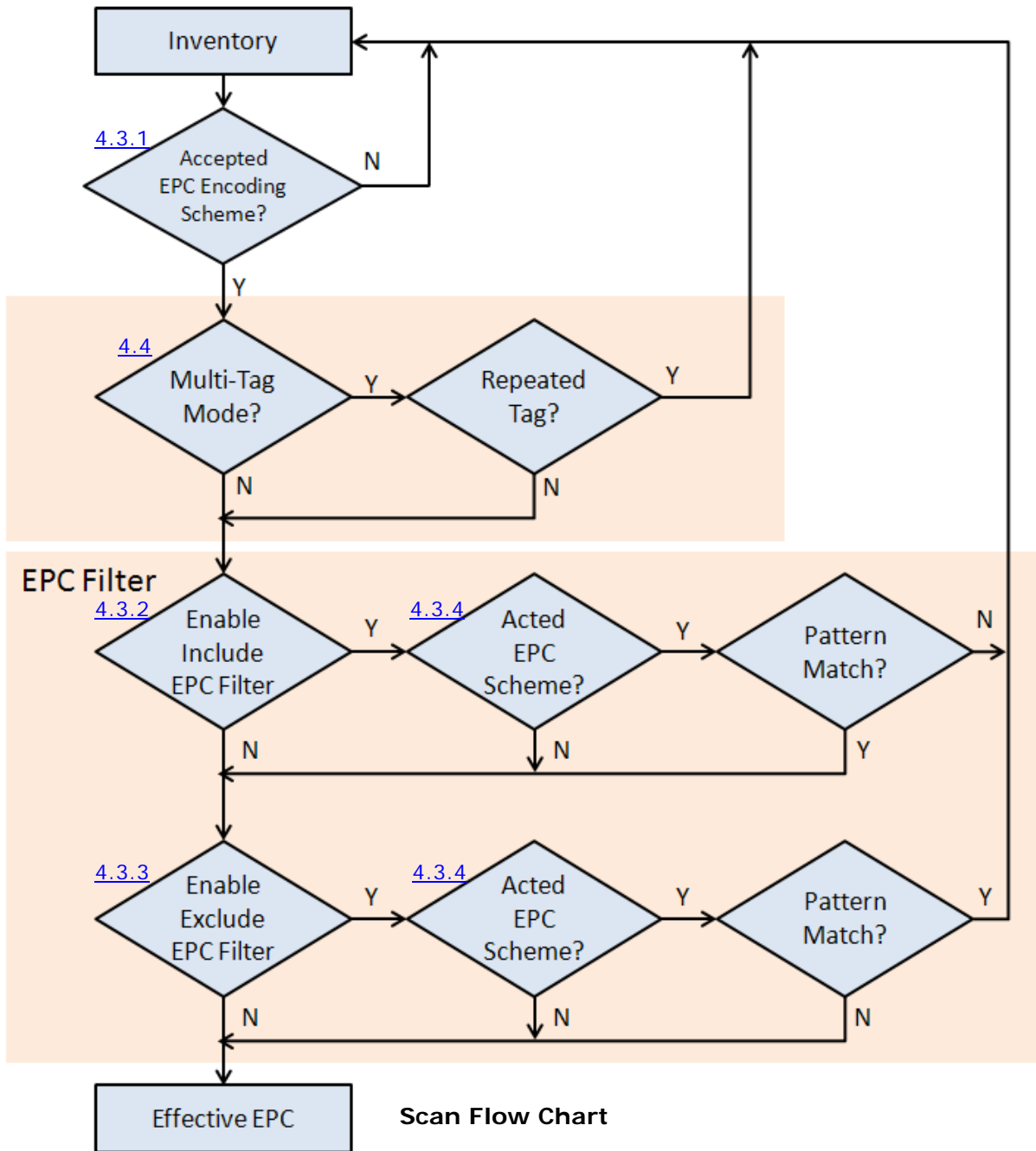

4.3.1 EPC ENCODING SCHEME

This function will decide which kind of tags can be read.

Accepted EPC Encoding Scheme – Group 1

Command:

#@rf_epctype1?\r

Purpose Get EPC Scheme – Group1

Response OK,[m]\r (Default = '11111111')

[m]: EPC Scheme – Group1

8 character series composed of "0" and "1" to enable or disable the listed tag types.

'0' – disable the tag type.

'1' – enable the tag type.

Character	Tag Type
1 (Left)	GDTI96
2	GSRN96
3	DoD96S
4	SGTIN96
5	SSCC96
6	GLN96
7	GRAI96
8(Right)	GIAI96

e.g. [m]="10011000" means only to enable GDTI96, SGTIN96,SSCC96

ERR,[code]\r

#@rf_epctype1=[m]\r

Purpose Set EPC Scheme – Group1

Response OK\r

ERR,[code]\r

Accepted EPC Encoding Scheme – Group 2

Command:

#@rf_epctype2?\r

Purpose Get EPC Scheme – Group2

Response OK,[m]\r (Default = '11111111')

[m]: EPC Scheme – Group2

8 character series composed of "0" and "1" to enable or disable the listed tag types.

0 → disable the tag type.

1 → enable the tag type.

Character	Tag Type
1 (Left)	GID96
2	SGTIN198
3	GRAI170
4	GIAI202
5	SGLN195
6	GDTI113
7	ADI
8(Right)	Reserved Always read and write as 1

ERR,[code]\r

#@rf_epctype2=[m]\r

Purpose Set EPC Scheme – Group2

Response OK\r

ERR,[code]\r

Note: If both EPC Scheme Group 1 and 2 are set to “11111111”, it means with accepting all tags.

4.3.2 AFFECTED TAG OF INCLUDED/EXCLUDED EPC FILTER

Note: The EPC encoding scheme described in Section 4.3.1 allows RFID reader to accept various types of tag. However, the EPC filter can pick only one type of tag from those EPC tags; other types will be bypassed.

Command:

#@rf_epcfcodes?\r

Purpose Get Tag type that EPC filter works on

Response OK,[m]\r (Default='30')

[m]: Acted Scheme for EPC Filter* Tag encoding type

[m]	EPC Encoding Scheme
'2C'	GDTI-96
'2D'	GSRN-96
'2F'	USDoD-96
'30'	SGTIN-96(Default)
'31'	SSCC-96
'32'	SGLN-96
'33'	GRAI-96
'34'	GIAI-96
'35'	GID-96
'36'	SGTIN-198
'37'	GRAI-170
'38'	GIAI-202
'39'	SGLN-195
'3A'	GDTI-113
'3B'	ADI

ERR,[code]\r

#@rf_epcfcodes=[m]\r

Purpose Set Tag type that EPC filter is applied to

Response OK\r

ERR,[code]\r

4.3.3 INCLUDED EPC

EPC filter is designed to check the contents of the EPC tag with the specified tag type to determine whether the scanned record is accepted or ignored. Besides configuring the tag type (refer to Section 4.3.2) to be filtered, users are supposed to specify start bits, length bits, and EPC pattern when using the EPC filter.

Start Bits

Define the start bit of EPC that you want to filter.

Command:

#@rf_sepceb?\r

Purpose	Get Included EPC Start bit
Response	OK,[m]\r (Default m= '0')
	[m]: Start bit of EPC. Max. 255 and sum of start bit and pattern length bit cannot be more than 256.
	ERR,[code]\r

#@rf_sepceb=[m]\r

Purpose	Set Included EPC Start bit
Response	OK\r
	ERR,[code]\r

Length Bits

The Max. value is 256. Sum of star bit and pattern length bit can not be more than 256.

- ▶ A value from 0 to 256 can be specified.
- ▶ EPC filter is disabled when the length is set to '0'.

Command:

#@rf_sepcl?\r

Purpose	Get Included EPC Length
Response	OK,[m]\r (Default m= '0')
	[m]: Pattern length bits. Max 256 and sum of start bit and pattern length bit cannot be more than 256.
	ERR,[code]\r

#@rf_sepcl=[m]\r

Purpose	Set Included EPC Length
Response	OK\r
	ERR,[code]\r

EPC Pattern

Define the hexadecimal pattern that is used to be compared.

Command:**#@rf_sepcpt?\r**

Purpose	Get Included EPC Pattern
Response	OK,[m]\r (Default m= '00')
	[m]: EPC pattern in hexadecimal value.
	ERR,[code]\r

#@rf_sepcpt=[m]\r

Purpose	Set Included EPC Pattern
Response	OK\r
	ERR,[code]\r

#@rf_sepcpt2?\r

Purpose	Get Included EPC2 Pattern
Response	OK,[m]\r (Default m= '00')
	[m]: EPC pattern in hexadecimal value.
	ERR,[code]\r

#@rf_sepcpt2=[m]\r

Purpose	Set Included EPC2 Pattern
Response	OK\r
	ERR,[code]\r

State

Disable or Enable Included EPC Filter function. When the value is set to '1', Tag EPC will be accepted upon fitting the required pattern. If the value is set to '2', Tag EPC will be accepted between pattern and pattern2. (Pattern<=Tag EPC<=Pattern2).

Command:**#@rf_sepcen?\r**

Purpose	Get Included EPC State
Response	OK,[m]\r (Default m= '0')
	[m]: '0' – disable, '1' – enable, '2' – enable range filter
	ERR,[code]\r

#@rf_sepcen=[m]\r

Purpose Set Included EPC State
Response OK\r
ERR,[code]\r

30003430333130303132303030304221
parameters of start bit 0 8 16 24 32 40

Start bit of EPC=0, Length=16, Pattern=3430

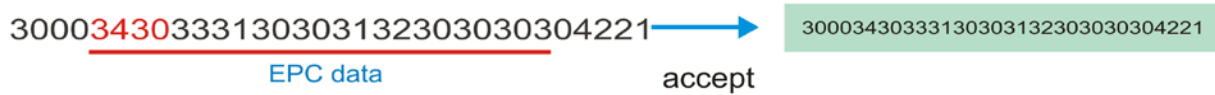

Start bit of EPC=16, Length=24, Pattern=333130

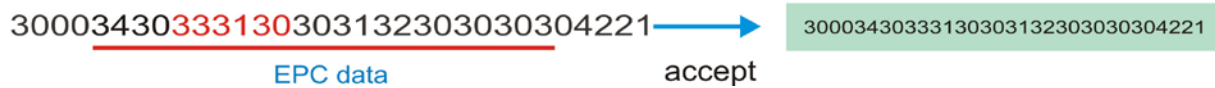

Note: The pattern must be consistent with length so that you can filter the transmitted data and accept it.

Example:**Command**

#@rf_sepccb=64 → set filter started from bit 64 of the EPC

Response (s)

OK

Command

#@rf_sepcl=8 → set filter length to 8 bits

Response (s)

OK

Command

#@rf_sepccp=06 → set filter pattern as 0x06

Response (s)

OK

Command

#@rf_epccode=31 → filter works on SSCC-96

Response (s)

OK

Command

#@rf_sepccen=1

Response (s)

OK

Tag1 EPC=3110AFEC2B0BEBC205000000 → reject

Tag2 EPC=3110AFEC2B0BEBC206000000 → accept

Tag3 EPC=3110AFEC2B0BEBC207000000 → reject

Tag4 EPC=3030AFEC2B09C44000000005 → accept. It's not SSCC-96. Bypass!

4.3.4 EXCLUDED EPC

The following commands are used to "exclude" tags matching the criteria set by the filter.

Start

Define the start bit of EPC that you want to filter.

Command:

#@rf_xepcsb?\r

Purpose	Get Excluded EPC Start bit
Response	OK,[m]\r (Default m= '0')
	[m]: Start bit of EPC. Max 255 and sum of start bit and pattern length bit cannot be more than 256.
	ERR,[code]\r

#@rf_xepcsb=[m]\r

Purpose	Set Excluded EPC Start bit
Response	OK\r
	ERR,[code]\r

Length

The Max. value is 256. Sum of star bit and pattern length bit can not be more than 256.

- ▶ A value from 0 to 256 can be specified.
- ▶ EPC filter is useless when the length is set to '0'.

Command:

#@rf_xepcl?\r

Purpose	Get Excluded EPC Length
Response	OK,[m]\r (Default m= '0')
	[m]: Pattern length bits. Max 256 and sum of start bit and pattern length bit cannot be more than 256.
	ERR,[code]\r

#@rf_xepcl=[m]\r

Purpose	Set Excluded EPC Length
Response	OK\r
	ERR,[code]\r

EPC Pattern

Define the hexadecimal pattern that is used to be compared.

Command:**#@rf_xepcpt?\r**

Purpose	Get Excluded EPC Pattern
Response	OK,[m]\r (Default m= '00')
	[m]: EPC pattern in hexadecimal value
	ERR,[code]\r

#@rf_xepcpt=[m]\r

Purpose	Set Excluded EPC Pattern
Response	OK\r
	ERR,[code]\r

#@rf_xepcpt2?\r

Purpose	Get Excluded EPC2 Pattern
Response	OK,[m]\r (Default m= '00')
	[m]: EPC pattern in hexadecimal value.
	ERR,[code]\r

#@rf_xepcpt2=[m]\r

Purpose	Set Excluded EPC2 Pattern
Response	OK\r
	ERR,[code]\r

State

Disable or Enable Excluded EPC Filter function. When the value is set to '1', Tag EPC will be eliminated upon matching the required pattern. If the value is set to '2', Tag EPC will be eliminated between pattern and pattern2. (Pattern<=Tag EPC<=Pattern2).

Command:**#@rf_xepcen?\r**

Purpose	Get Excluded EPC State
Response	OK,[m]\r (Default m= '0')
	[m]: '0' – disable, '1' – enable, '2' – enable range filter
	ERR,[code]\r

#@rf_xepcen=[m]\r

Purpose Set Excluded EPC State
Response OK\r
ERR,[code]\r

30003430333130303132303030304221
parameters of start bit 0 8 16 24 32 40

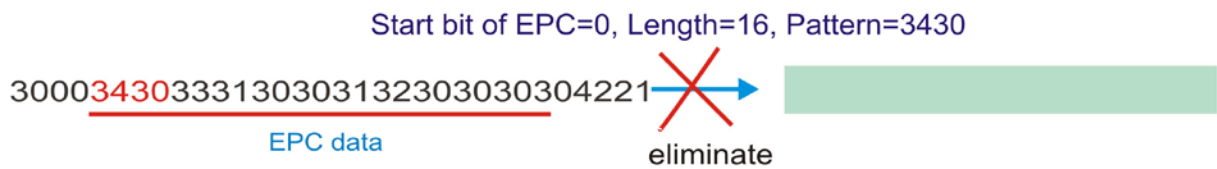

Note: The pattern must be consistent with length so that you can filter the transmitted data.

Example:**Command**

#@rf_xepcsb=64 → set filter started from bit 64 of the EPC

Response (s)

OK

Command

#@rf_xepc1=8 → set filter length to 8 bits

Response (s)

OK

Command

#@rf_xepcpt=06 → set filter pattern as 0x06

Response (s)

OK

Command

#@rf_epcfcodes=31 → filter works on SSCC-96

Response (s)

OK

Command

#@rf_xepcen=1

Response (s)

OK

Tag1 EPC=3110AFEC2B0BEBC205000000 → accept

Tag2 EPC=3110AFEC2B0BEBC206000000 → reject

Tag3 EPC=3110AFEC2B0BEBC207000000 → accept

Tag4 EPC=3030AFEC2B09C44000000005 → accept. It's not SSCC-96. Bypass!

4.4 MULTI-TAG

4.4.1 COUNTER

In order to prevent sending redundant tags to PC or mobile computer, the RFID reader creates a tag list to compare the scanned tags, discard redundant tags, and output/store new (unique) tags. The new (unique) tags will be added to the list as the comparing patterns. To do this we use a counter for that list with the maximum count up to 128 records. When the maximum number of records is reached, the reader will not scan any tags until the counter is reset.



Note: The Multi-Tag Counter command is used to set the counter value of a tag list. If the value is set to '0', the list is disabled and all scanned tags are recorded or sent to PC/mobile computer.

Counter

Command:

#@rf_mtagcnt?\r

Purpose Get Multi-Tag Counter Value

Response OK,[m]\r (Default m= '128')

[m]: Multi-Tag Counter value: '0' (disable the counter), '1' ~'128'

ERR,[code]\r

#@rf_mtagcnt=[m]\r

Purpose Set Multi-Tag Counter

Request #@rf_mtagcnt=[m]\r

[m]: Multi-Tag Counter

Response OK\r

ERR,[code]\r

Multi-Tag List Type

Command:

#@rf_mtaglist?\r

Purpose Get Multi-Tag List Type

Response OK,[m]\r (Default m= '0')

[m]: Multi-Tag List Type

'0' – EPC

'1' TID

ERR,[code]\r

#@rf_mtaglist=[m]\r

Purpose Set Multi-Tag List Type

Response OK\r

ERR,[code]\r

4.4.2 COUNTER RELOAD

When the tag list is full, please issue "#@rf_mtagcnt=[m]\r" command again to reset the counter. Once reset, the tag list is cleared and scanning tasks can be continued.

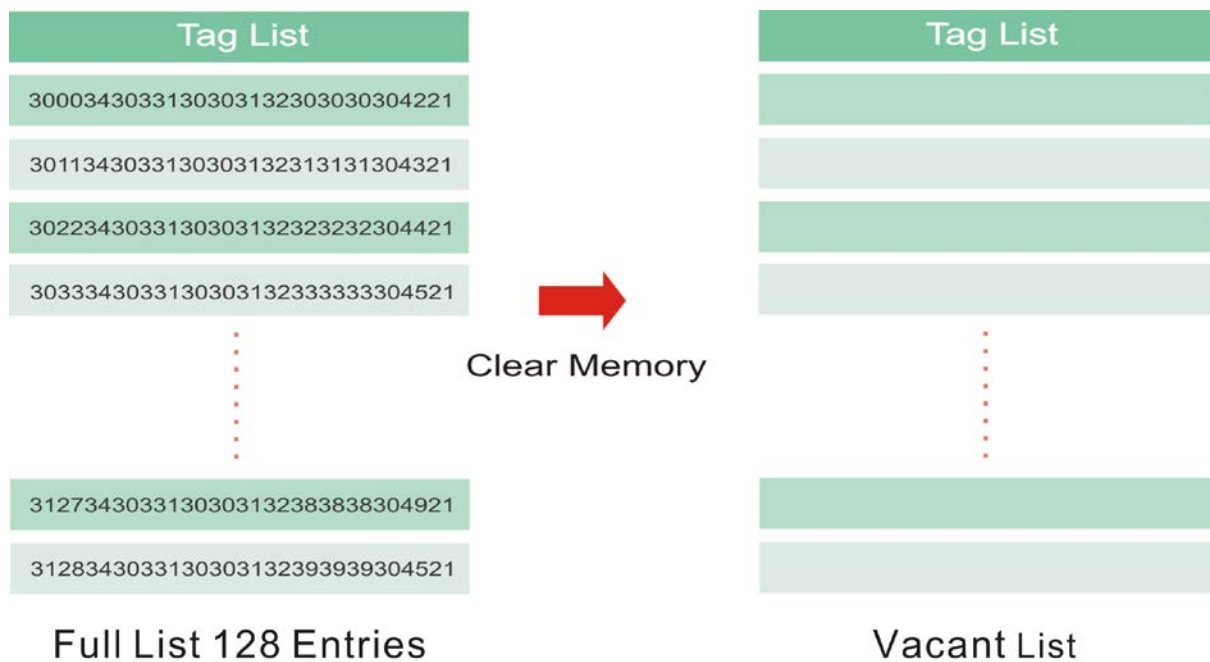

4.4.3 MULTI-TAG BEEP

In order to differentiate between tags read, the reader will beep in the following sequence:

- ▶ Get a new tag: one short beep with high tone denoting that a tag is scanned successfully. Please refer to 1.5 Beeper.
- ▶ Get a repeated tag: one short beep with low tone (disabled by default)
- ▶ Full Tag List: six short beeps, low-mid-high-low-mid-high (enabled by default)

Beeping Status

Enabling the beeper for multi-tag beeping can be set using the following commands.

Command:

#@rf_mtagbeep?\r

Purpose	Get Multi-Tag Beeping
Response	OK,[m],[n]\r (Default m= '0', n= '1')
	[m]: Repeated Tag Beeping
	[n]: Tag List Full Beeping
	ERR,[code]\r

#@rf_mtagbeep=[m],[n]\r

Purpose	Set Multi-Tag Beeping
Request	#@rf_mtagbeep=[m],[n]\r
	[m]: Repeated Tag Beeping. '0' – Disable, '1' – Enable
	[n]: Tag List Full Beeping. '0' – Disable, '1' – Enable
Response	OK\r
	ERR,[code]\r

4.5 ACCESS TAG

4.5.1 TAG MEMORY

A tag memory is divided into 4 banks as below:

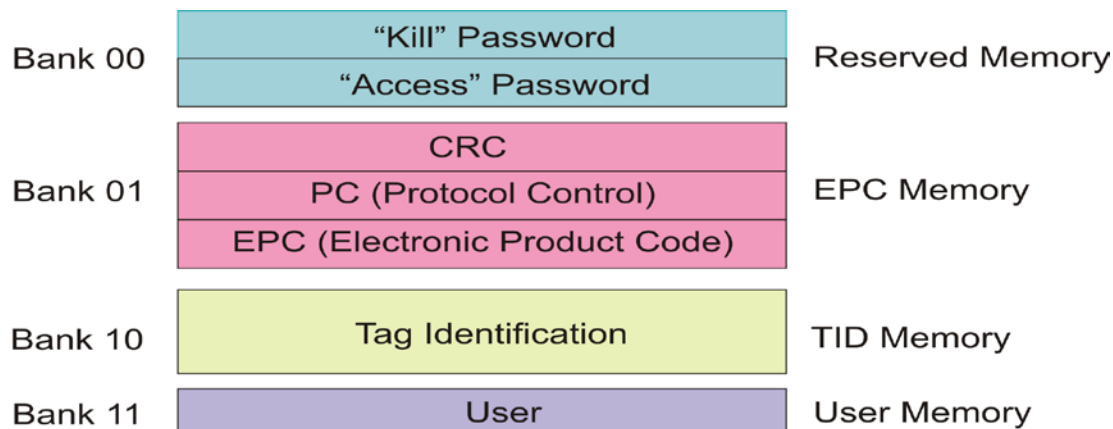

Reserved Memory:

This area of memory holds the tag's passwords:

- ▶ A 32-bit **"Kill"** password that allows a Tag to be permanently silenced.
 - The default Kill password value is zero.
 - The **Kill** command will only execute if the password has been set, i.e. is non-zero.
- ▶ A 32-bit **"Access"** password that allows the Tag to transition to the **Secured** state.
 - A Tag in the **Secured** state can execute all **Access** commands, including writing to locked blocks.

Reserved memory can be read-locked.

EPC Memory:

This memory includes three partitions:

- ▶ A 16-bit CRC
 - The actual data is the 1's complement of the published CRC-16 definition.
- ▶ A 16-bit Protocol Control (PC)
 - 5 bits is for the length of PC + EPC.
 - 2 bits is RFU (00₂).
 - 9 bits is for a numbering system ID (NSI), which may contain an EPCglobal™ header or an AFI as defined in ISO 15961.
- ▶ An EPC (includes Header, General Manager Number, Object Class and Serial Number)
 - The electronic product code of the object to which the Tag is attached.

TID Memory:

This memory includes:

- ▶ An 8-bit ISO 15963 allocation class identifier
 - For EPCglobal™ Tags as 0xE2.
- ▶ A 12-bit Tag mask-designer ID
- ▶ A 12-bit Tag model number
- ▶ Allow to add other information if required e.g. Tag serial number

User Memory:

This optional area of memory contains user-specific data.

4.5.2 READ/WRITE TAG

By default, the RFID Reader access mode is set to Inventory to get EPC of a Tag. If you want to read all data stored in a Tag, you would issue the “#@rf_func=1” command that allows you to read Reserved, EPC, TID or User bank.

RFID Function

Command:

#@rf_func?\r

Purpose Get RFID Function

Response OK,[m]\r (Default m= '0')

[m]: RFID Function

- '0' – Inventory
- '1' – Read Tag Memory
- '2' – Write Tag Memory

ERR,[code]\r

#@rf_func=[m]\r

Purpose Set RFID Function

Response OK\r

ERR,[code]\r

Access

Command:

#@rf_rwidx?\r

Purpose Get Index of Access Parameter

Response OK,[m]\r

[m]: Index of Access Parameter

[m]	Meaning	Value
'0'	Access Password	'xxxxxxx' Access Password, 4 bytes, shown in Hexadecimal value. e.g. String '30313233' indicates 0x30, 0x31, 0x32, 0x33. Default= '00000000'
'1'	Memory Bank	'0' – Reserved Bank

		'1' – EPC '2' – TID '3' – User Bank Default= '1'
'2'	Start Byte	Only even numbers ('0', '2', '4' ... '32') are valid for the start byte. Default= '0'
'3'	Data Length Byte(s)	Only even numbers ('0', '2', '4' ... '32') are valid for data length bytes. Default= '0'

ERR,[code]

#@rf_rwidx=[m]\r

Purpose Set Index of Access Parameter

Response OK\r

ERR,[code]\r

#@rf_rwpr?\r

Purpose Get Access Parameter

Response OK,[m]\r

[m]: Access Parameter

ERR,[code]\r

#@rf_rwpr=[m]\r

Purpose Set Access Parameter

Response OK\r

ERR,[code]\r

Write

In addition to specifying parameters mentioned above, you are supposed to store data into RFID reader's buffer before writing them into the tag memory.

Command:

#@rf_wbuf?\r

Purpose Get Data in Reader Buffer

Response OK,[m]\r (Default m= '0000')

[m]: Data stored in buffer shown in hexadecimal.

e.g. '41'=>0x41= 'A' (2 bytes NULL)

ERR,[code]\r

#@rf_wbuf=[m]\r

Purpose Store Data into Reader Buffer

Request #@rf_wbuf=[m]\r

[m]: Data to be stored in buffer

Buffer size = 32 bytes

Input data shown in hexadecimal.

The length of data must be an even number.

To clear the buffer, [m]= '0000'

Response OK\r

ERR,[code]\r

Example (Read Tag Memory):

Command

#@rf_rwidx=1

Response (s)

OK

Command

#@rf_rwpr=2 → to read TID Bank

Response (s)

OK

Command

#@rf_rwidx=2

Response (s)

OK

Command

#@rf_rwpr=0 → start from byte 0 of TID Bank

Response (s)

OK

Command

#@rf_rwidx=3

Response (s)

OK

Command

#@rf_rwpr=0 → to read the whole bank

Response (s)

OK

Command

#@rf_func=0 → inventory

Response (s)

OK

1. 12-09-07 10:22 07.91
30003515fd8560082350000000066d36 → after pressing the trigger

Command

#@rf_func=1 → set function to read Tag memory

Response (s)

OK

2. 12-09-07 10:22 46.85
30003515fd8560082350000000066d36e2006001011fcdc5
(the 'e2006001011fcdc5' string is Tag ID) → after pressing the trigger

Example (Write Tag Memory):**Command**

#@rf_rwidx=1

Response (s)

OK

Command

#@rf_rwpr=3 → to write User Bank

Response (s)

OK

Command

#@rf_rwidx=2

Response (s)

OK

Command

#@rf_rwpr=0 → start from byte 0 of User Bank

Response (s)

OK

Command

#@rf_rwidx=3

Response (s)

OK

Command

#@rf_rwpr=8 → to write 8 bytes data

Response (s)

OK

Command

#@rf_wbuf=3132333435363738 → store 8 bytes data into reader buffer before writing into Tag

Response (s)

OK

Command

#@rf_func=2 → set function to write Tag memory

Response (s)

OK

4.6 ADVANCED SETTINGS

4.6.1 APPLICATIONS IN MULTIPLE TAGS ENVIRONMENT

In an energizing RF field, Tags implement a slot counter into which a random value involving the Q-parameter is loaded and Readers use the slot counter to regulate the probability of a Tag responding to commands of the Inventory operation.

In practical applications, the ability of the Reader to read multiple Tags is affected by the Q value. Greater Q value allows the Reader to identify and collect information from more Tags; however, the reading distance will thus be decreased, and vice versa. The Q value should be set to zero in the case of a single Tag field. For the multiple Tags field, Q should be increased depending on the amount of Tags. A valid Q value can take any integer between 0 and 15.

Command:

#@rf_q?\r

Purpose	Get the Current Q Value
Response	OK,[m]\r [m]: Q value Valid integer value ranging from 0 to 15 (default=0 for 1861; default=4 for 1862) ERR,[code]\r

#@rf_q=[m]\r

Purpose	Set New Q Value
Request	[m]: The number of slots (Q) for the inventory round.
Response	OK\r ERR,[code]\r

4.6.2 ADJUSTMENT FOR OUTPUT POWER LEVEL OF THE READER

Reading distance of the Reader varies according to its output power level. The output power level is set to the maximum value by default. Users can decrease the power level for reasons such as:

- ▶ Within the same frequency band, you may try to prevent RF interference for your own reason or to comply with the regulations.
- ▶ For near field applications, you want to write data into the nearest Tag ensuring that the data won't be written into neighbouring ones.

Command:

#@rf_plv?\r

Purpose	Get the Current Output Power Level of the Reader
Response	OK,[m]\r [m]: Output power level For 1861, valid power level ranges from 0 to 3. Default value is set to 3. For 1862, valid power level ranges from 0 to 19. Default value is set to 15. ERR,[code]\r

#@rf_plv=[m]\r

Purpose	Set New Output Power Level of the Reader
Request	[m]: Output power level
Response	OK\r ERR,[code]\r

DEFINING OUTPUT FORMAT

You may configure the format of the collected data being output to the host computer. Data transmission of the tags read can have various formats. The following sections will describe the available options.

- 1) Decide the output format.
- 2) Define the data fields for Time stamp, Data Count and Data sections.
- 3) Set separators for each section.
- 4) Define output length of the data.
- 5) Add [Prefix Code](#) and [Suffix Code](#) before transmission.
- 6) Decide the output sequence of Time stamp, Data Count and Data sections.

IN THIS CHAPTER

5.1 Output Format	124
5.2 Format Editing for Hexadecimal and Raw Data	126
5.3 Prefix/Suffix Code	142
5.4 Output EPC Data via USB Virtual COM	145

5.1 OUTPUT FORMAT

Before transmitting data captured by the reader you can edit, add and re-order the sequence of the final transmitted data. There are standard formats for the specified interfaces described below.

BT SPP/USB VCOM via 3610

The output formats for *Bluetooth*[®] SPP/USB VCOM via 3610 can be one of Packet Data, Hexadecimal and Raw Data. The default value is Packet Data.

BT HID/USB HID via 3610

The output formats for *Bluetooth*[®] HID/USB HID via 3610 can be one of Hexadecimal and Raw Data. The default value is Hexadecimal.

Note: *Bluetooth*[®] HID or USB HID via 3610 interface does not support Packet Data as an output format.

Command:

#@dat_fmt?\r

Purpose Get Current Output Data Format

Response OK,[m]\r (Default m= '0')

[m]: Output Data Format

[m]	BT SPP / USB VCOM via 3610	BT HID / USB HID via 3610
'0'	Packet Data	Hexadecimal
'1'	Hexadecimal	
'2'	Raw Data	Raw Data

ERR,[code]\r

#@dat_fmt=[m]\r

Purpose Set New Output Data Format

Response OK\r

ERR,[code]\r

Example:

Packet Data:

In order to enhance data reliability during transmission, header and checksum are added before transmitting. This is normally used for terminal application programming. Please note that Packet data does not allow any editing features.

Hexadecimal:

The output data consists of 16 unique symbols, the numbers 0 to 9 and the letters A to F. Specified for every byte (8 bits) as two consecutive hexadecimal digits. It is easier for users to read hexadecimal numbers than binary numbers.

Command

#@dat_fmt=1 → set output data format to Hexadecimal Data

Response (s)

OK

1. 12-04-11 23:56 44.46 30003430333130303132303030304221

→ Hexadecimal Data

Raw Data:

As the name implies, raw data output will be recorded and displayed faithfully according to the original data type. In this case, the output data type will be in Hexadecimal, but adopting the sequence and options selected by the user.

Command

#@dat_fmt=2 → set output data format to Raw Data

Response (s)

OK

2. 12-04-12 00:03 10.49 040310012000030B! → Raw Data

Please see the picture illustrated below for quick reference.

Output format

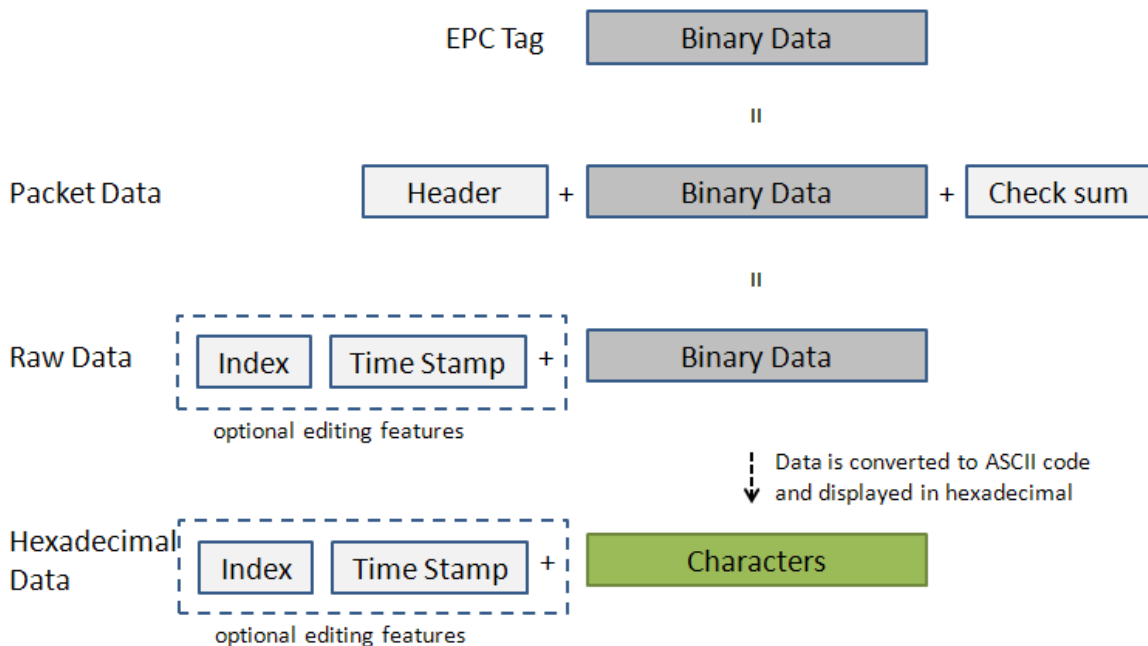

5.2 FORMAT EDITING FOR HEXADECIMAL AND RAW DATA

When the data format is specified for Hexadecimal or Raw Data, you can configure the data sections described as below:

- ▶ Each section can be enabled or disabled.
- ▶ Each section has individual prefix and suffix.
- ▶ The sequence of sections can be adjusted.

Default Format:

Section 1			Section 2			Section 3		
Prefix	Data Counter	Suffix	Prefix	Timestamp	Suffix	Prefix	EPC Tag	Suffix

Command:

#@dat_seq?\r

Purpose Get the Setting of Output Data Sequence
 Response OK,[m],[n],[o]\r (Default m= '1', n= '2', o= '3')

[m]: Section in sequence 1
 [n]: Section in sequence 2
 [o]: Section in sequence 3

Data section will be one of the following:

[m]/[n]/[o]	Section
'0'	Disable this section
'1'	Count section
'2'	Time Stamp section
'3'	UHF Data section

ERR,[code]\r

#@dat_seq=[m],[n],[o]\r

Purpose Set Output Data Sequence
 Response OK\r
 ERR,[code]\r

Example 1:

- ▶ Sequence 1 : Counter Section
- ▶ Sequence 2 : Timestamp Section
- ▶ Sequence 3 : UHF Data Section

Command

#@dat_seq?

→ get output data sequence

default sequence: Counter, Timestamp, UHF data

Response (s)

OK,1,2,3

Example 2:

- ▶ Sequence 1 : EPC tag Section
- ▶ Sequence 2 : Disabled
- ▶ Sequence 3 : Disabled

Command

#@dat_seq=3,0,0

→ set to show EPC tag section only

Response (s)

OK

30003430333130303132303030304221

Example 3:

- ▶ Sequence 1 : Timestamp Section
- ▶ Sequence 2 : EPC tag Section
- ▶ Sequence 3 : Disabled

Command

#@dat_seq=2,3,0

→ set to show 1. Timestamp and 2. EPC tag

Response (s)

OK

2012-04-16 Mon 00:08 37.08 30003430333130303132303030304221

sequence 1

sequence 2

5.2.1 DATA COUNTER SECTION

Define a serial number to output data. The serial number would be specified in 6 digits beginning from 000001. When the counter is up to 999999, it will be reset to 000001.

Default Format:

Prefix	Field	Suffix
'\0' (0x00)	Counter	'.' (0x2E)

Reset Counter Event

There are three events supported to reset the counter. With the parameter set to '1', the counter will be reset when the event occurs.

Command:

#@dat_rstcnt?\r

Purpose Get the Setting of Reset Counter Event

Response OK,[m],[n],[o]\r (Default m= '1', n= '0', o= '1')

	Reset Event	Enable	Disable
[m]	Reset Counter command accepted	'1'	'0'
[n]	UHF Power On	'1'	'0'
[o]	new <i>Bluetooth</i> [®] connection established	'1'	'0'

ERR,[code]\r

#@dat_rstcnt=[m],[n],[o]\r

Purpose Enable/Disable Counter Reset Event

Response OK\r

ERR,[code]\r

#@dat_rstcnt\r

Purpose Reset Data Counter

Response OK\r

ERR,[code]\r

Note: Besides the configurable events above, Data Counter will also be reset when system powers up.

Example:**Command**

```
#@dat_rstcnt? → get the values of reset counter events
```

Response (s)

```
OK,1,1,1
```

```
  26.    04-13-2012  30003430333130303132303030304221
```

Command

```
#@dat_rstcnt → run the reset counter command
```

Response (s)

```
OK
```

```
  1.    04-13-2012  30003430333130303132303030304221 → re-count
```

```
  2.    04-13-2012  30003430333130303132303030304221
```

```
  3.    04-13-2012  30003430333130303132303030304221
```

Counter Padding

For data display alignment purposes, you can define padding characters to show the counter value with fixed 6-digit. Characters to be padded or retrieved are shown in Hexadecimal. Please refer to [ASCII Table](#). The default value is 0x20 (space) for '20' displayed.

Command:

#@dat_cntpad?\r

Purpose Get the Setting of Pad Counter Character
 Response OK,[m]\r (Default m= '20' - 0x20 space)
 [m]: Character to be padded before data counter, shown in Hexadecimal value.
 ERR,[code]\r

#@dat_cntpad=[m]\r

Purpose Set the Character to be Padded before Counter
 Response OK\r
 ERR,[code]\r

Example:

Command

#@dat_cntpad? → get counter padding

Response (s)

OK,20 → 20 is for 'space' referred to ASCII table '0x20'
 10. 04-13-2012 30003430333130303132303030304221

Command

#@dat_cntpad=2a → set counter padding to 2a as '*' referred to ASCII table '0x2a'

Response (s)

OK
 **** 11. 04-13-2012 30003430333130303132303030304221

5.2.2 TIME STAMP SECTION

Time Stamp section is divided into 7 fields as year, month, day, weekday, hour, minute and second. Separators can be defined among fields to make more clear presentation. Up to 6 separators can be specified to Time Stamp section.

Default Format:

Prefix	Field1	Step1	Field2	Step2	Field3	Step3	Field4	Step4	Field5	Step5	Field6	Step6	Field7	Suffix
'_' (0x2D)	Year	'_' (0x2D)	Month	'_' (0x2D)	Day	'_' (0x20)	Disable	'_' (0x20)	Hour	'_' (0x3A)	Minute	'_' (0x20)	Second	'_' (0x2D)

Time Stamp Sequence

Issue "#@dat_tseq=" command to configure the fields of Time Stamp section. You can set the parameter to '0' to disable the field.

Command:

#@dat_tseq?\r

Purpose Get the Sequence Settings of Time Stamp Section

Response OK,[m],[n],[o],[p],[q],[r],[s]\r (Default m= '1', n= '2', o= '3', p= '0', q= '5', r= '6', s= '7')

[m]: Time Data Type in Field 1

[n]: Time Data Type in Field 2

[o]: Time Data Type in Field 3

[p]: Time Data Type in Field 4

[q]: Time Data Type in Field 5

[r]: Time Data Type in Field 6

[s]: Time Data Type in Field 7

[m]~[s]	Field
'0'	Disable this Field
'1'	Year
'2'	month
'3'	day
'4'	weekday
'5'	Hour
'6'	Minute
'7'	second

ERR,[code]\r

#@dat_tseq=[m],[n],[o],[p],[q],[r],[s]\r

Purpose Set the Sequences of Field in Time Stamp Section

Response OK\r

[m]: Time Data Type in Field 1. Default = '1'

[n]: Time Data Type in Field 2. Default = '2'

[o]: Time Data Type in Field 3. Default = '3'

[p]: Time Data Type in Field 4. Default = '0'

[q]: Time Data Type in Field 5. Default = '5'

[r]: Time Data Type in Field 6. Default = '6'

[s]: Time Data Type in Field 7. Default = '7'

ERR,[code]\r

Example:

Command

#@dat_tseq=1,2,3,0,0,0,0 → set to show year, month and day only

Response (s)

OK

24. 2012-04-12 30003430333130303132303030304221

Command

#@dat_tseq=2,3,1,0,0,0,0 → change the sequences of year, month and day

Response (s)

OK

25. 04-13-2012 30003430333130303132303030304221

Note: If the field is disabled, its following separator will also be ignored.

Time Stamp Separators

You can configure the separator between fields. The separator to be configured or retrieved can present in ASCII characters or hexadecimal numbers. Refer to [ASCII Table](#)

Command:

`#@dat_tsprh?\r, #@dat_tspr?\r`

Purpose	Get the Separators of Field in Time Stamp Section
Request	<code>#@dat_tsprh?\r</code> //Response data will be shown in Hexadecimal value. <code>#@dat_tspr?\r</code> //Response data will be shown in character.
Response	OK,[m],[n],[o],[p],[q],[r]\r [m]: separator follows field1. Default= '2D' ('-') [n]: separator follows field2. Default= '2D' ('-') [o]: separator follows field3. Default= '20' (' ') [p]: separator follows field4. Default= '20' (' ') [q]: separator follows field5. Default= '3A' (':') [r]: separator follows field6. Default= '20' (' ') ERR,[code]\r

`#@dat_tspr=[m],[n],[o],[p],[q],[r],[s]\r`

Purpose	Set the Separators of Field in Time Stamp Section
Request	<code>#@dat_tspr=[m],[n],[o],[p],[q],[r],[s]\r</code> [m]: input data format, '0'- in Hexadecimal, '1'- in character [n]: separator follows field1 [o]: separator follows field2 [p]: separator follows field3 [q]: separator follows field4 [r]: separator follows field5 [s]: separator follows field6
Response	OK\r ERR,[code]\r

Note: Input '00' (hexadecimal) to clear the inputted data.

Example:

Command

#@dat_tseq=1,2,3,4,5,6,7 → enable all fields

Response (s)

OK

19. 2012-04-12 Thu 23:04 08.34 30003430333130303132303030304221

Command

#@dat_tsprh? → get the separators with hexadecimal format

Response (s)

OK,2d,2d,20,20,3a,20

Command

#@dat_tspr? → get the separators with character format

Response (s)

OK,-,-, , ,:,

Command

#@dat_tspr=0,3a,3a,00,00,00,00 → reset the separators with hexadecimal format

Response (s)

OK

20. 2012:04:12Thu230557.61 30003430333130303132303030304221

Command

#@dat_tspr=1,/,, ,/,,/ → reset the separators with character format

Response (s)

OK

20. 2012/04/12 Thu/23/06/34.61 30003430333130303132303030304221

Year

For year output field, you can define it as 2 digits or 4 digits.

Command:

#@dat_tyear?\r

Purpose Get the Setting of Year Field

Response OK,[m]\r (Default m= '0'.)

[m]: Year format. 0 – 2 digits, 1 – 4 digits (shown as '20xx').

ERR,[code]\r

#@dat_tyear=[m]\r

Purpose Set the Year Field

Response OK\r

[m]: Year format. m= '0' is for 2 digits, m= '1' is for 4 digits (shown as '20xx').

ERR,[code]\r

Example:

Command

#@dat_tyear? → default format for year is 2 digits

Response (s)

OK,0

3. 12-04-12 05:44 59.47 30003430333130303132303030304221

Command

#@dat_tyear=1 → set year format to 4 digits

Response (s)

OK

4. 2012-04-12 05:44 59.47 30003430333130303132303030304221

Time

You can enable this function to display time in seconds with the scale of two digits to the right of the decimal point if second field is enabled.

Command:

#@dat_tms?\r

Purpose Get Time Format
 Response OK,[m]\r (Default m= '1')
 [m]: Display time in seconds with two digits after the decimal point.
 0 – Disable, 1 – Enable
 ERR,[code]\r

#@dat_tms=[m]\r

Purpose Set to Display Time
 Request #@dat_tms=[m]\r
 [m]: Display time in seconds with two digits after the decimal point.
 0 – Disable, 1 – Enable
 Response OK\r
 ERR,[code]\r

Example:

Command

#@dat_tms? → get the displaying format of seconds

Response (s)

OK,1
 5. 2012-04-12 05:44 59.47 30003430333130303132303030304221
 ↑ display time in seconds with two digits after the decimal point

Command

#@dat_tms=0 → set to display time in seconds without decimals

Response (s)

OK
 6. 2012-04-12 05:44 59 30003430333130303132303030304221

5.2.3 EPC TAG SECTION

The EPC tag section is divided into 5 fields as PC, EPC, CRC, Memory Data and Data Length. Separators can be defined among fields for clarity. Up to 4 separators can be specified for this section.

Default Format:

Prefix	Field1	Step1	Field2	Step2	Field3	Step3	Field4	Step4	Field5	Suffix
'\0' (0x00)	PC	'\0' (0x00)	EPC	'\0' (0x00)	CRC	'\0' (0x00)	Memory Data	'\0' (0x00)	Disable	'\r' (0x0D)

Command:

#@dat_rfseq?\r

Purpose Get the Sequence Setting of EPC Tag Data Section

Response OK,[m],[n],[o],[p],[q]\r

[m]: EPC Tag Data in Field 1 (default: '2' – PC)

[n]: EPC Tag Data in Field 2 (default: '3' – EPC)

[o]: EPC Tag Data in Field 3 (default: '1' – CRC)

[p]: EPC Tag Data in Field 4 (default: '4' – Memory Data)

[q]: EPC Tag Data in Field 5 (default: '0' – Disable)

[m]~[q]	Description
'0'	Disable this Field
'1'	CRC
'2'	PC
'3'	EPC
'4'	Memory Data This field only appears when RFID function is set to "Read Tag Memory"
'5'	Data Length

ERR,[code]\r

#@dat_rfseq=[m],[n],[o],[p],[q]\r

Purpose Set the Sequence of Each Field in EPC Tag Data Section

Response OK\r

ERR,[code]\r

Example:

Command

#@rf_func? → get RFID function

Default is inventory

Response (s)

OK,0

18. 2012-04-12 Fri 04:00 55.95 30003430333130303132303030304221

Command

#@dat_rfseq?

→ get the sequence of RFID Data

Default sequence is PC, EPC and then CRC

Response (s)

OK,2,3,1,4,0

19. 2012-04-12 Fri 04:00 55.95 3000 343033313030313230303030 4221

PC +

EPC

+ CRC

Command

#@dat_rfseq=3,0,0,0,0

→ only show EPC

Response (s)

OK

20. 2012-04-12 Fri 04:00 55.95 343033313030313230303030

EPC

UHF Data Separators

The separator to be configured or retrieved can present in ASCII characters or hexadecimal numbers. Refer to [ASCII Table](#).

Command:

#@dat_rfsprh?\r, #@dat_rfspr?\r

Purpose	Get the Separators of Each field in EPC Tag Data Section
Request	#@dat_rfsprh?\r Response data will be shown in Hexadecimal value #@dat_rfspr?\r Response data will be shown in character
Response	OK,[m],[n],[o],[p]\r [m]: separator follows field1. Default= '00' (NULL) [n]: separator follows field2. Default= '00' (NULL) [o]: separator follows field3 . Default= '00' (NULL) [p]: separator follows field4 . Default= '00' (NULL) ERR,[code]\r

#@dat_rfspr=[m],[n],[o],[p],[q]\r

Purpose	Set the Separators of Each field in EPC Tag Data Section
Request	#@dat_rfspr=[m],[n],[o],[p],[q]\r [m]: input data format, '0'- in Hexadecimal, '1'- in character [n]: separator between field1 and field2 [o]: separator between field2 and field3 [p]: separator between field3 and field4 [q]: separator between field4 and field5
Response	OK\r ERR,[code]\r

Note: Input '00' (hexadecimal) to clear the inputted data.

Example:

Command	
#@dat_rfspr?	→ get the separators in character format
Response (s)	
OK,	
Command	
#@dat_rfsprh?	→ get the separators in hexadecimal format
Response (s)	
OK,00,00,00,00 21. 2012-04-12 Fri 04:00 55.95 34303331303031323030303030004221	
Command	
#@dat_rfsprh=0,2d,2d,2d,2d	→ reset the separators using hexadecimal format e.g. 2d is specified for '-'
Response (s)	
OK 22. 2012-04-12 Fri 04:00 55.95 343033313030313230303030-3000-4221-	
Command	
#@dat_rfsprh=1,/,,/,/	→ reset the separators using character format
Response (s)	
OK 23. 2012-04-12 Fri 04:00 55.95 343033313030313230303030/3000/4221/	

Note: If a specific field is disabled, its following separator will be ignored.

Data Length

Enable the Data Length function to show the length for UHF Data, EPC and memory data.

Command:

#@dat_rflen?\r

Purpose	Get the Setting of UHF Data Length
Response	OK,[m]\r (Default m= '0')
	[m]: Data Length Type
	'0'- Total UHF Data Length. Separators are not included.
	'1'- EPC Length
	'2'- Memory Data Length
	ERR,[code]\r

Note: UHF data length is not related to the appearance of fields. For example, when the field is set to display EPC data only with data length set to "Total UHF Data Length", data length will include PC and CRC data even though the two data fields are not displayed.

#@dat_rflen=[m]\r

Purpose	Set the RFID Data Length
Response	OK\r
	ERR,[code]\r

Example:

Command

#@dat_rfseq? → get the sequence of RFID data

Response (s)

OK,2,3,1,4,0 → default data length is '0' not transmitted
 33. 2012-04-12 Fri 04:00 55.95 34303331303031323030303030004221_

Command

#@dat_rfseq=2,3,1,4,5 → set to '5' to display data length

Response (s)

OK,2,3,1,4,5
 34. 2012-04-12 Fri 04:00 55.95 3430333130303132303030303000422116
 → total data length is 16 bytes including PC (2 bytes), EPC (12 bytes), and (CRC 2 bytes)

Command

#@dat_rflen? → get the RFID data length setting

Response (s)

OK,0

35. 2012-04-12 Fri 04:00 55.95 3430333130303132303030303000422116

→ display total data length

Command

#@dat_rflen=1 → change the value to 1 displaying the EPC length only

Response (s)

OK,2,3,1,4,5

36. 2012-04-12 Fri 04:00 55.95 3000343033313030313230303030422112

→ EPC data length is 12 bytes

Command

#@dat_rflen=2 → change the value to 2 displaying the Memory data length only

Response (s)

OK

37. 2012-04-12 Fri 04:00 55.95 300034303331303031323030303042210

→ fail to read the Tag Memory data so the data length is 0

5.3 PREFIX/SUFFIX CODE

Prefix/Suffix codes can be utilized for applications like data section prompt string, separating string, carriage return or other auxiliary data-identification. Each data section has its own individual prefix/suffix codes up to 8 bytes.

Prefix/Suffix Index

For a prefix or suffix index, you have to specify for which section (e.g. Data Counter, Time Stamp or EPC Tag Data) you want to apply it to.

Command:

#@dat_pfxidx?\r

Purpose Get Prefix/Suffix Buffer Index

Response OK,[m]\r

[m]: Prefix / Suffix Index

[m]	Description
'1'	Prefix of Data Counter Section
'2'	Suffix of Data Counter Section
'3'	Prefix of Time Stamp Section
'4'	Suffix of time Stamp Section
'5'	Prefix of EPC Tag Data Section
'6'	Suffix of EPC Tag Data Section

ERR,[code]\r

#@dat_pfxidx=[m]\r

Purpose Specify Prefix/Suffix Buffer Index

Response OK\r

ERR,[code]\r

Prefix/Suffix

Command:**#@dat_pfxh?\r, #@dat_pfx?\r**

Purpose Get Prefix/Suffix

- ▶ Request
 - ▶ #@dat_pfxh?\r Response data will be shown in Hexadecimal value
 - ▶ #@dat_pfx?\r Response data will be shown in character

Response OK,[m]\r

[m]: Prefix/Suffix stored in the index-specified buffer

ERR,[code]\r

#@dat_pfx= [m],[n]\r

Purpose Set Prefix/Suffix

Response OK\r

[m]: input data format, '0'- in Hexadecimal, '1'- in character

[n]: Prefix/Suffix to be stored in the index-specified buffer

ERR,[code]\r

	Default
Prefix of Counter Section	'00' (NULL)
Prefix of Time Stamp Section	'20' (SPACE)
Prefix of EPC Tag Data Section	'00' (NULL)
Suffix of Counter Section	'2E' (.)
Suffix of Time Stamp Section	'20' (SPACE)
Suffix of EPC Tag Data Section	'0D' (CR)

Example1 (Prefix of the Counter Section):**Command**

```
#@dat_pfx=0,23 → set prefix to 0x23 ('#')
```

Response (s)

OK

```
# 39. 2012-04-12 Fri 04:00 55.95 3000343033313030313230303030422112
```

Command

```
#@dat_pfx=0,23436f756e74657223 → set prefix to 0x23, 0x43, 0x6f, 0x75, 0x6e, 0x74, 0x65, 0x72, 0x23 (respective characters are: #, C, o, u, n, t, e, r, #); the length exceeds 8 bytes so the last code 0x23 ('#') will be truncated.
```

Response (s)

OK

```
#Counter 40. 2012-04-12 Fri 04:00 55.95 30003430333130303132303030304221
```

Command

```
#@dat_pfx=1,@ → set prefix to '@'
```

Response (s)

OK

```
@ 41. 2012-04-12 Fri 04:00 55.95 30003430333130303132303030304221
```

Example2 (Suffix of the EPC Data Section):**Command**

```
#@dat_pfxidx=6 → setting the prefix/suffix buffer index to 6 means to configure the suffix of the EPC data section
```

Response (s)

OK

Command

```
#@dat_pfx=0,454e440d → set the suffix to 0x45, 0x4e, 0x44, 0x0d (respective characters are: E, N, D, \r)
```

Response (s)

OK

```
42. 2012-04-12 Fri 04:00 55.95 30003430333130303132303030304221END
```

5.4 OUTPUT EPC DATA VIA USB VIRTUAL COM

Users can decide whether to output data via the USB Virtual COM port. Once the 'm' parameter of this command is set to '1', the EPC data originally transmitted by *Bluetooth*[®] communications will be output by the USB Virtual COM port. Thus, *Bluetooth*[®] communications stop outputting the EPC data.

Command:

#@dat_2usb?\r

Purpose Get the Setting Value

Response OK,[m]\r

[m]: Output EPC Data via USB Virtual COM

'0'	Disable (default)
'1'	Enable outputting EPC Data via USB Virtual COM

ERR,[code]\r

#@dat_2usb=[m]\r

Purpose Specify the Setting

Response OK\r

ERR,[code]\r

ALTERNATE MODE

Shift the reader switch to the **EXT.** position to have 1800 RFID reader enter Alternate mode. In Alternate mode, 1800 RFID reader won't read tags with the trigger being pressed. Function keys described in [1.3.1 RFID Mode](#) are also not available. Instead, defined key events are sent to the mobile computer as strings.

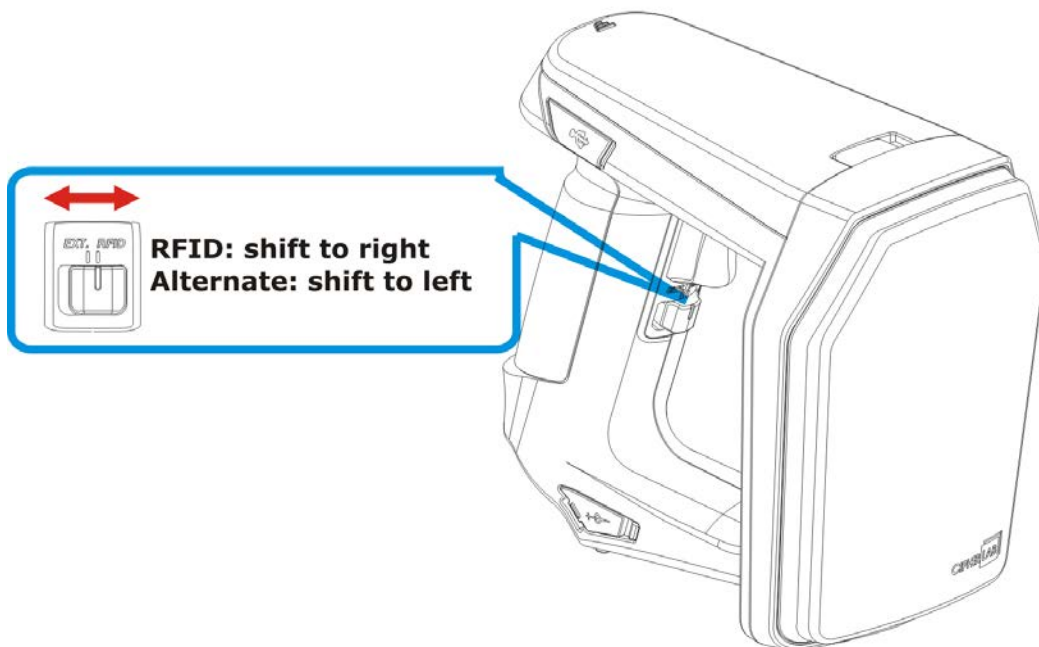

You can transmit the specified key actions to host via *Bluetooth*[®] in Alternate mode. The reader supports up to 6 output strings and 8 key actions for users to select or edit.

Index	Key Action	String (10byte)
1	1 (Press Trigger)	#@TRIG_ON\r
2	2 (Release Trigger)	#@TRIG_OFF\r
3	0 (Disable)	NULL
4	0 (Disable)	NULL
5	0 (Disable)	NULL
6	0 (Disable)	NULL

Table 6.1: Default output string and key action combination table

Output String

Define the string first before defining the action to be executed.

Command:

#@dat_ostridx?\r

Purpose Get Output String index
Response OK,[m]\r (Default m= '1')
[m]: String Buffer Parameter 1~6
ERR,[code]\r

#@dat_ostridx=[m]\r

Purpose Set Output String index
Response OK\r
ERR,[code]\r

Key Action

Command:

#@dat_ostrkey?\r

Purpose Get Key Action of Output String
Response OK,[m]\r
[m]: Key Action

[m]	Action
'0'	Disable
'1'	Trigger key is pressed
'2'	Trigger key is released
'3'	F1 is pressed
'4'	F1 is released
'5'	F2 is pressed
'6'	F2 is released
'7'	F1+ Trigger key are pressed
'8'	F2 + Trigger key are pressed

ERR,[code]\r

#@dat_ostrkey=[m]\r

Purpose Set Key Action of Output String, refer to [Table 6.1](#)

Response OK\r
ERR,[code]\r

Output String Data

Output strings have a maximum length of 10 characters and can be defined in Hexadecimal or in ASCII characters. Strings longer than 10 characters will be truncated.

Command:

#@dat_ostrh?\r, #@dat_ostr?\r

Purpose Get Output String

Request #@dat_ostrh?\r Response data will be shown in Hexadecimal value
#@dat_ostr?\r Response data will be shown in character

Response OK,[m]\r
[m]: Data is stored in buffer.
ERR,[code]\r

#@dat_ostr=[m],[n]\r

Purpose Set Output String, refer to [Table 6.1](#)
[m]: specify the data format, '0'- in Hexadecimal, '1'- in character
[n]: Data to be stored in buffer

Response OK\r
ERR,[code]\r

#@dat_ostr=1,#@iOSKBD\r

Purpose This command is used to have the on-screen keyboard of iPad/iPhone showing up when the *Bluetooth*[®] connection type is HID.

Response OK\r
ERR,[code]\r

Note: Specify '00' (hexadecimal) to clear the input data.

Example:

Command

#@dat_ostridx=3 → set to string 3

Response (s)

OK

Command

#@dat_ostrkey=3 → set to use key action '3' (press F1)

Response (s)

OK

Command

#@dat_ostr=1,F1_ON → define the output string 3 data using character format

Response (s)

OK

Command

#@dat_ostr?

Response (s)

OK, F1_ON → get the output string 3 data in character format

Command

#@dat_ostrh?

Response (s)

OK, 46315f4f4e → show the output string 3 data in hexadecimal format

Command

#@dat_ostridx=4 → set output string index to 4

#@dat_ostrkey=5 → set the action "F2 is pressed" to send the string

#@dat_ostr=1,#@iOSKBD → enter "#@iOSKBD" as the string to be sent

Response (s)

OK

→ when the RFID reader acts as a Bluetooth HID keyboard connecting to iPhone/iPad, users can press the F2 button to bring up or hide the on-screen keyboard of iPhone/iPad.

SPECIFICATIONS

SYSTEM

Model Designation	1861	1862
Operating System & CPU		
Operating System	CipherLab Proprietary Operation System	
CPU	ARM Cortex-M3	
Memory		
Memory Mode	4MB	
Transmit Buffer	2KB	
Clock		
RTC	<ul style="list-style-type: none"> ▶ Operating tolerance: ± 10sec./30 days ▶ Calibrated by PC application via USB or <i>Bluetooth</i>[®] 	

COMMUNICATIONS

USB	Micro USB 2.0 (full-speed); Virtual COM (CDC / SiliconLab driver)	
Bluetooth [®]	<i>Bluetooth</i> [®] version 2.1 + EDR Class 2 connectivity	<i>Bluetooth</i> [®] version 4.0 dual mode (2.1+EDR / BLE) Class 1 connectivity
	<ul style="list-style-type: none"> ▶ Antenna: Internal ▶ <i>Bluetooth</i>[®] Type: SPP Master/Slave, HID, 3610 	

READER

UHF RFID		
Protocol	EPC global UHF Gen2, ISO 18000-6c	
Operating Frequency	<ul style="list-style-type: none"> ▶ 865 – 868MHz ETSI (Europe) ▶ 902 – 928MHz US, Canada, South America , include 908.5 – 914MHz Korea ▶ 952 – 954MHz Japan 	<ul style="list-style-type: none"> ▶ 865 – 868MHz ETSI (Europe) ▶ 902 – 928MHz US, Canada, South America , include 908.5 – 914MHz Korea
Antenna Module Type	Tuning for regions individually	
Output Power	Max. 24dBm	Max. 30dBm

Read Range (depending on tags and environments)	Up to 100cm	300 ~ 500cm
Write Range (depending on tags and environments)	Up to 50cm	Up to 150cm

ELECTRICAL CHARACTERISTICS

Battery		
Type	Rechargeable Li-ion battery – 2500mAh	
Charging Time	4hrs by adapter	
Working Time	10 hours, 5 sec./scan, one tag at 1m distance	8 hours, 5 sec./scan, one tag at 1m distance
Consumption		
Standby	150mW	

PHYSICAL CHARACTERISTICS

Notifications	
Status LED	LED – Red / Green / Blue / Yellow / White
Beeper	85 dB at 10cm, 4KHz
Vibrator	0.5G
Enclosures	
Materials	Polycarbonate
Dimensions	163.5 mm (L) 85.7 mm (W) 146.5 mm (H)
Weight (battery included)	520 g/18.3 oz.

ENVIRONMENTAL CHARACTERISTICS

Temperature	
Operating	-10 °C to 60 °C
Storage	-30 °C to 70 °C
Humidity	
10% to 95%, non-condensing	
Resistance	
Impact Resistance	1.5 m
Tumble Test	500 times at 100 cm
Splash/Dust Resistance	IP64
Electrostatic Discharge	± 15 kV air discharge, ± 8 kV contact discharge

PROGRAMMING SUPPORT

Development Environment & Tools	
Integrated Development Environment	Visual Studio 2008 Visual Studio 2005
Software Development Kit	<ul style="list-style-type: none"> ▶ RFID Reader SDK ▶ C#/.Net Programming for 9 Series ▶ C Programming for 8 Series ▶ .NET SDK for Windows and Windows Mobile development
Software & Utilities	
Cipherlab software package	<ul style="list-style-type: none"> ▶ 1800Configuration Utility for PC ▶ CP series Configuration Utility ▶ EZConfig Utility for PC (.NET environment) ▶ EZEdit Utility for PC ▶ 8 Series Configuration Utility ▶ 9 Series Configuration Utility

ACCESSORIES

Accessory Options	
<ul style="list-style-type: none"> ▶ Spare Rechargeable Li-ion Battery ▶ External Battery Charger ▶ USB Cable ▶ Power Cable ▶ Mobile Computer Mount 	

FIRMWARE UPGRADE

BEFORE UPGRADING

- ▶ Ensure the RFID reader has a fully charged battery prior to attempting a firmware upgrade.
- ▶ In order to avoid the data loss during firmware upgrade. Please save or upload all the data from the flash memory before beginning firmware upgrade.

Command:

Purpose	Download Firmware
Request	#@sys_dlfw=[m]\r
	[m]: '0' – Current interface
	'1' – <i>Bluetooth</i> [®]
	'2' – USB
Response	OK\r
	ERR,[code]\r

Note: When the 'OK' response is received, please end HyperTerminal and run the ProgLoad.exe utility to begin firmware upgrade.

HOW TO UPGRADE FIRMWARE

USE USB VIRTUAL COM

- 1) Use the provided USB cable to connect RFID Reader to the USB port of host computer. You will need to install USB cable driver first.
- 2) Refer to [Using HyperTerminal](#) for connecting with USB cable.
- 3) Issue “#@sys_dlfw=0” or “#@sys_dlfw=2” command.
- 4) End HyperTerminal.
- 5) Run the download utility “ProgLoad.exe” on the host computer.

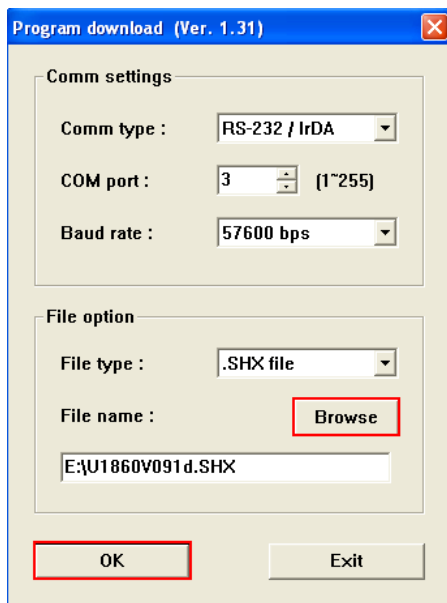

- ▶ For the communication settings, select “RS-232/IrDA” and the correct COM port for Direct USB Virtual COM interface.
- ▶ Ignore the baud rate setting.
- ▶ For the file option, click [Browse] to select the target file e.g. U1860V*.SHX for firmware update.
- ▶ Click [OK].

- 6) After upgrading, RFID Reader will restart automatically.

USE *BLUETOOTH*[®] DONGLE

Please refer to [3.1.3 Bluetooth[®] HID and SPP Slave](#) for the connection with *Bluetooth*[®] dongle, and go through steps 3 (run "#@sys_dlfw=0" or "#@sys_dlfw=1" command) to 6 described in the Use USB Virtual COM section.

USE 3610

Please refer to [3.2 Connecting via 3610](#) for connecting to 3610, and go through steps 3 (run "#@sys_dlfw=0" or "#@sys_dlfw=1" command) to 6 described in the Use USB Virtual COM section.

Note: Please upgrade firmware to one RFID reader at a time, while using *Bluetooth*[®] connection. For example, turn off each of the rest RFID readers when there is more than one RFID reader connected to host computer.

USE <F2>+<TRIGGER>

- 1) Power Off RFID Reader.
- 2) Press and hold the <F2>+<Trigger> for 3 seconds to enter Firmware Upgrade mode.
- 3) Use USB cable to connect RFID Reader and host computer.
- 4) Run the download utility "ProgLoad.exe" on host computer to upgrade the firmware.

Note: <F2>+<Trigger> firmware upgrade only supports Windows CDC Virtual COM driver. Please refer to [2.1 USB Interface](#) to configure USB type.

ASCII TABLE

	0	1	2	3	4	5	6	7
0		DLE	SP	0	@	P	`	p
1	SOH	DC1	!	1	A	Q	a	q
2	STX	DC2	"	2	B	R	b	r
3	ETX	DC3	#	3	C	S	c	s
4	EOT	DC4	\$	4	D	T	d	t
5	ENQ	NAK	%	5	E	U	e	u
6	ACK	SYN	&	6	F	V	f	v
7	BEL	ETB	'	7	G	W	g	w
8	BS	CAN	(8	H	X	h	x
9	HT	EM)	9	I	Y	i	y
A	LF	SUB	*	:	J	Z	j	z
B	VT	ESC	+	;	K	[k	{
C	FF	FS	,	<	L	\	l	
D	CR	GS	-	=	M]	m	}
E	SO	RS	.	>	N	^	n	~
F	SI	US	/	?	O	_	o	DEL

SCAN CODE

	00	10	20	30	40	50	60	70	80	90	A0	B0	C0	D0	E0	F0
00	00	10	20	30	40	50	60	70	80	90	A0	B0	C0	D0	E0	F0
01	01	11	21	31	41	51	61	71	81	91	A1	B1	C1	D1	E1	F1
02	02	12	22	32	42	52	62	72	82	92	A2	B2	C2	D2	E2	F2
03	03	13	23	33	43	53	63	73	83	93	A3	B3	C3	D3	E3	F3
04	04	14	24	34	44	54	64	74	84	94	A4	B4	C4	D4	E4	F4
05	05	15	25	35	45	55	65	75	85	95	A5	B5	C5	D5	E5	F5
06	06	16	26	36	46	56	66	76	86	96	A6	B6	C6	D6	E6	F6
07	07	17	27	37	47	57	67	77	87	97	A7	B7	C7	D7	E7	F7
08	08	18	28	38	48	58	68	78	88	98	A8	B8	C8	D8	E8	F8
09	09	19	29	39	49	59	69	79	89	99	A9	B9	C9	D9	E9	F9
0A	0A	1A	2A	3A	4A	5A	6A	7A	8A	9A	AA	BA	CA	DA	EA	FA
0B	0B	1B	2B	3B	4B	5B	6B	7B	8B	9B	AB	BB	CB	DB	EB	FB
0C	0C	1C	2C	3C	4C	5C	6C	7C	8C	9C	AC	BC	CC	DC	EC	FC
0D	0D	1D	2D	3D	4D	5D	6D	7D	8D	9D	AD	BD	CD	DD	ED	FD
0E	0E	1E	2E	3E	4E	5E	6E	7E	8E	9E	AE	BE	CE	DE	EE	FE
0F	0F	1F	2F	3F	4F	5F	6F	7F	8F	9F	AF	BF	CF	DF	EF	FF

STATUS CODE

value	Meaning
0xDD	Fail to configure the parameter of USB HID via 3610
0xDE	Incorrect <i>Bluetooth</i> [®] type (The parameter of <i>Bluetooth</i> [®] type is not consistent with connected device.)
0xDF	Fail to set system time (Real Time Clock cannot be configured.)
0xED	Unsupported UHF command (UHF module firmware needs to be upgraded)
0xEE	Conflict in Scan Mode and RFID Function (Write Tag Memory function is not available in Continuous and Test Modes.)
0xEF	RFID Fail (Unable to configure RFID module upon Q value and Module Power Level Command configurations.)
0xFA	Invalid transmit buffer setting
0xFD	Invalid parameter in the Data field
0xFF	Invalid command or parameters