

# CipherLab Reference Manual

RS51 Mobile Computer  
(RS51\_HS)  
Android™ 8.1, Oreo™

Version 1.03



Copyright © 2019 CIPHERLAB CO., LTD.  
All rights reserved

The software contains proprietary information of its owner; it is provided under a license agreement containing restrictions on use and disclosure and is also protected by copyright law. Reverse engineering of the software is prohibited.

Due to continued product development, this information may change without notice. The information and intellectual property contained herein is confidential between the owner and the client and remains the exclusive property of the owner. If having any problems in the documentation, please report them to us in writing. The owner does not warrant that this document is error-free.

No part of this publication may be reproduced, stored in a retrieval system, or transmitted in any form or by any means, electronic, mechanical, photocopying, recording or otherwise without the prior written permission of the owner.

For product consultancy and technical support, please contact the local sales representative. Also, visit our website for more information.

All brand, logo, product and service, and trademark names are the property of their registered owners.

Google, Android, Google Play, Google Drive, YouTube and other marks are trademarks of Google LLC; Oreo is a trademark of Mondelez International, Inc. group.

The Android robot is reproduced or modified from work created and shared by Google and used according to terms described in the Creative Commons 3.0 Attribution License. The editorial use of these names is for identification as well as to the benefit of the owners, with no intention of infringement.

CIPHERLAB logo is a registered trademark of CIPHERLAB CO., LTD.. All other brands, products and services, and trademark names are the property of their registered owners. The editorial use of these names is for identification as well as to the benefit of the owners, with no intention of infringement.

CIPHERLAB CO., LTD.  
Website: <http://www.CipherLab.com>

---

## IMPORTANT NOTICES

---

FOR USA



Tested to Comply with FCC Standards

***FOR HOME OR OFFICE USE***

FCC ID: Q3N-RS51

This equipment has been tested and found to comply with the limits for a **Class B** digital device, pursuant to Part 15 of the FCC Rules. These limits are designed to provide reasonable protection against harmful interference in a residential installation. This equipment generates, uses and can radiate radio frequency energy and, if not installed and used in accordance with the instructions, may cause harmful interference to radio communication. However, there is no guarantee that interference will not occur in a particular installation. If this equipment does cause harmful interference to radio or television reception, which can be determined by turning the equipment off and on, the user is encouraged to try to correct the interference by one or more of the following measures:

- ▶ Reorient or relocate the receiving antenna.
- ▶ Increase the separation between the equipment and receiver.
- ▶ Connect the equipment into an outlet on a circuit different from that to which the receiver is connected.
- ▶ Consult the dealer or an experienced radio/TV technician for help.

This device complies with Part 15 of the FCC Rules. Operation is subject to the following two conditions: (1) This device may not cause harmful interference, and (2) this device must accept any interference received, including interference that may cause undesired operation.

**FCC Caution:**

Any changes or modifications not expressly approved by the party responsible for compliance could void the user's authority to operate this equipment.

This transmitter must not be co-located or operating in conjunction with any other antenna or transmitter.

Find the certificate information from:

**Setup → About Phone → Regulatory information**

## FOR PRODUCT WITH LASER

- ▶ This laser component emits FDA / IEC Class 2 laser light at the exit port. Do NOT STARE INTO BEAM DIRECTLY.
- ▶ Do not aim the beam at the eyes.
- ▶ Any adjustments or performance excluding those specified herein may result in hazardous laser light exposure.



## ENVIRONMENT

- ▶ Operate the mobile computer at ambient temperatures from -20°C to 50°C and with humidity range from 10% to 90%.
- ▶ Store the device at ambient temperatures from -30°C to 70°C and with humidity range from 5% to 85%.
- ▶ Charge the device at ambient temperatures from 0°C to 40°C.
- ▶ This device is built with a dust-proof and splash-proof structure that conforms to protection class IP65/67.

## SPECIFIC ABSORPTION RATE (SAR) INFORMATION

The product complies with the FCC portable RF exposure limit set forth for an uncontrolled environment and are safe for intended operation as described in this manual. The further RF exposure reduction can be achieved if the products can be kept as far as possible from the user body or set the device to lower output power if such function is available.

### Body-worn Operation

This device was tested for typical body-worn operations. To comply with RF exposure requirements, a minimum separation distance of 10 mm must be maintained between the user's body and the handset, including the antenna. Third-party belt-clips, holsters, and similar accessories used by this device should not contain any metallic components.

Body-worn accessories that do not meet these requirements may not comply with RF exposure requirements and should be avoided.

The SAR test distance is Head (0 mm), Body (10 mm) and Hotspot (10 mm).

FCC SAR Value (Standard limit is 1.6 W/Kg)

USA (1g): Max. 1.52 W/Kg

A minimum separation distance of 0.5 cm must be maintained between the user's body and the device, including the antenna during body-worn operation to comply with the RF exposure requirements in Europe. To compliance with RF Exposure requirements in Europe, third-party belt-clips, holsters or similar accessories used by this device should not contain any metallic components. The use of accessories that do not satisfy these requirements may not comply with RF exposure requirements, and should be avoided.

CE SAR Value (Standard limit is 2 W/Kg) EU (10g): Max. 1.48 W/Kg

## SAFETY PRECAUTIONS



### **Warning statement:**

A pleine puissance, l'écoute prolongée du baladeur peut endommager l'oreille de l'utilisateur.

To prevent possible hearing damage, do not listen at high volume levels for long periods.

### **For people's safety**

- ▶ Do not listen at high volume levels for long periods to prevent possible hearing damage.
- ▶ Do not operate this device while walking, cycling or car driving.

### **For the equipment**

- ▶ Do not use any batteries or charging devices which are not originally sold or manufactured by CIPHERLAB CO., LTD.
- ▶ Do not replace the battery with an incorrect type, to avoid the risk of heat generation, fire, or explosion.
- ▶ Do not disassemble, incinerate or short circuit the battery.
- ▶ Do not touch the contact pins of the battery pack.
- ▶ Do not expose the mobile computer or battery to any flammable sources.
- ▶ Do not expose the mobile computer to extreme temperatures or soak it in water.
- ▶ Do not use any pointed or sharp objects against the screen surface.
- ▶ Do not use the styluses which are not supplied or approved by CIPHERLAB CO., LTD., to prevent possible scratches to the touch screen.
- ▶ Water residue on the touch screen may cause abnormal behaviors or the fall of its sensitivity levels.
- ▶ On the surface of the terminal and the barcode reading window, the fog or water drops caused by low temperatures may influence barcode reading.
- ▶ Do not use bleaches or cleaners to clean the device. Use a clean, wet cloth instead.

## BATTERY

- ▶ Risk of explosion if battery is replaced by an incorrect type. Dispose of used batteries according to the instructions.
- ▶ The main battery may not be charged to full for shipment. Charge the main battery to full before using the mobile computer for the first time.
- ▶ **Main battery:** The main battery powers the mobile computer to work. It takes approximately 4 hours to charge an empty main battery to full. For the first time charging the main battery, please charge it for at least 8 to 12 hours. The charging LED above the screen will light up in red while charging and will turn green when charging is complete.
- ▶ When the main battery is removed, RTC retention will be maintained for at least 30 minutes.
- ▶ **Backup battery:** The backup battery is mounted on the main board. Its role is to temporarily keep the mobile computer in suspension when the main battery is drained out so data in DRAM will be retained. The backup battery takes approximately 4 hours to charge to full by the main battery or power adapter.
- ▶ The allowed battery charging ambient temperature is between 0°C to 40°C. It is recommended to charge the battery at room temperature (18°C to 25°C) for optimal performance.
- ▶ Battery charging stops when ambient temperature drops below 0°C or exceeds 40°C.
- ▶ In order to prevent system from shutting down after the battery is drained out, keep a fresh battery for replacement at all times, or connect the mobile computer to an external power.
- ▶ If there are drippings or dust on the device or battery pack, wipe them away with a soft clean cloth before battery replacement.
- ▶ Turn off the power before battery replacement.
- ▶ If you want to put away the mobile computer for a period of time, remove the battery pack from the mobile computer's battery compartment. Store the mobile computer and battery pack separately.
- ▶ Recycle batteries in a proper way for the green-environment issue.

## SCANNER

- ▶ Scan a 1D barcode
  - 1) Open **ReaderConfig** and tap **Scan Test** on the menu bar.
  - 2) Aim the scanning window at the barcode to read. Move the device, having the barcode located in the center of the scanning area.
  - 3) Press any of the two side triggers. The scanning light beams to read the printed barcodes. The buzzer beeps after scanning. The scanning light goes off once the data is decoded, or when the decode timeout period has passed.
- ▶ Scan a 2D barcode
  - 1) Open **ReaderConfig** and tap **Scan Test** on the menu bar.
  - 2) Aim the scanning window at the barcode to read. Move the device, having the barcode located in the center of the scanning area.
  - 3) Press any of the two side triggers. The scanning light beams to read the printed barcodes. The buzzer beeps after scanning. The scanning light goes off once the data is decoded, or when the decode timeout period has passed. USA and Canada e-label

---

## CONNECTION

### Via Bluetooth or WLAN

- ▶ Connection may fail when the mobile computer is around other wireless machines or power cables as the radio frequencies of those may cause interferences.
- ▶ If communication fails, move the devices much closer to each other, and try to communicate again
- ▶ After turning on, Bluetooth power is sustained even when the mobile computer is suspended. However, if the power mode is switched to Airplane Mode, Bluetooth power will be turned off regardless of the settings.

### To a charging cradle

- ▶ Do not insert the mobile computer to a charging cradle if water or drippings are staying on the device.
- ▶ The LED indicator on a charging cradle shows the status of battery charging only; the status of terminal charging is shown on the device itself.
- ▶ Not Charging could be the result of battery damage, battery's failure to touch the connector or AC plug coming off.
- ▶ Charging error could be due to high battery temperature.

## CARE & MAINTENANCE

- ▶ This mobile computer is intended for industrial use. The mobile computer is rated IP65/67, however, damage may be done to the mobile computer if it is exposed to extreme temperatures or soaked in water.
- ▶ When the body of the mobile computer gets dirty, use a clean, wet cloth to wipe off dust and debris. DO NOT use bleaches or cleaners.
- ▶ Use a clean, non-abrasive, lint-free cloth to wipe dust off the LCD touch screen. DO NOT use any pointed or sharp objects against the surface. Always keep the LCD dry.
- ▶ If you want to put away the mobile computer for a period of time, download the collected data to a host computer, and then remove the battery pack from the mobile computer's battery compartment. Store the mobile computer and battery pack separately.
- ▶ If you encounter malfunction on the mobile computer, write down the specific scenario and consult your local sales representative.

---

---

**E-LABEL**

Mobile Computer  
Model : RS51

**US**

FCC ID : Q3N-RS51



This device complies with Part 15 of the FCC Rules.  
Operation is subject to the following two conditions:  
(1) This device may not cause harmful interference, and  
(2) this device must accept any interference received,  
including interference that may cause undesired operation.

**TW**

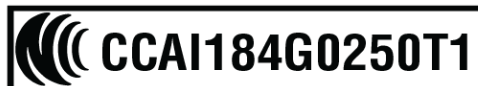

減少電磁波影響,請妥適使用



## EUROPE – EU DECLARATION OF CONFORMITY

*Manufacturer***CIPHERLAB Co., Ltd.**

12F., 333, Dunhua S. Rd., Sec. 2

Taipei, Taiwan 106, R.O.C.

Tel: +886 2 8647 1166

<http://www.cipherlab.com>*Europe*

CipherLab Europe Representative Office

Flight Forum 40,

5657 DB Eindhoven, The Netherlands

Tel : +31 (0) 40 295 1510

<http://www.cipherlab.eu>*Type of Equipment***Mobile Computer***Model(s) Declared***RS51***Initial Year of Manufacture***2019**

Reference to the specification under which conformity is declared in accordance with Council Directive- 2014/30/EU(EMC), 2014/35/EU(LVD), 2011/65/EU (RoHS), 1999/519/EC (EMF), 2014/53/EU (RED).

EN 300 328 V2.1.1

EN 303 413 V1.1.1

EN 301 511 V12.5.1

EN 301 908-2 V11.1.2

EN 300 330 V2.1.1

EN 50360 :2017

EN 61000-3-2 :2014

EN 55024 : 2010+A1:2015

EN 55032: 2015+AC:2016

EN 60950-1 : 2006+A2:2013

EN 301 893 V2.1.1

EN 50663:2017

EN62311:2008

EN 301 489-1 V2.1.1

EN 301 489-3 V2.1.1

EN 50566:2017

EN 61000-3-3 :2013

EN 301 489-52 V1.1.0

EN 301 489-17 V3.1.1

EN 301 489-19 V2.1.0

EN 301 908-1 V11.1.1

EN 62479:2010

EN 301908-13 V11.1.2

EN 50332-2:2013

*I the undersigned, hereby declare that the equipment specified above conforms to the above Directive(s) and Standard(s).*

*Manufacture Signature*
*Full Name :Herbie Jiang**Title : Manager**Date: 2019.1.3*

## THAILAND CAUTION

เครื่องโทรคมนาคมและอุปกรณ์นี้มีความสอดคล้องตามมาตรฐานหรือข้อกำหนดของกสทช.



เครื่องวิทยุคมนาคมนี้มีอัตราการดูดกลืนพลังงานจำเพาะ (Specific Absorption Rate - SAR)  
อันเนื่องมาจากเครื่องวิทยุคมนาคมเท่ากับ 1.48 W/kg  
ซึ่งสอดคล้องตามมาตรฐานความปลอดภัยต่อสุขภาพของมนุษย์จากการใช้เครื่องวิทยุคมนาคมที่คณะกรรมการ  
การกิจการโทรคมนาคมแห่งชาติประกาศกำหนด

## RELEASE NOTES

---

Version	Date	Notes
1.03	July 26, 2019	Add " <b>Thailand Caution</b> ".
1.02	July 23, 2019	Update specifications.
1.01	June 21, 2019	Update all figures. Update " <b>Important Notices</b> " Update " <b>Safety Precautions</b> " Update Section 3.3.1 " <b>Application Menu</b> " Update Chapter 6 " <b>Using Reader Configuration Utility</b> " Update " <b>Specifications</b> " Update Appendix II
1.00	Nov. 30 <sup>th</sup> , 2018	Initial release



# CONTENTS

---

<b>IMPORTANT NOTICES</b> .....	<b>- 3 -</b>
For USA .....	- 3 -
For Product with Laser .....	- 4 -
Environment.....	- 4 -
Specific Absorption Rate (SAR) information .....	- 4 -
Safety Precautions.....	- 5 -
Battery.....	- 6 -
Scanner.....	- 6 -
Connection.....	- 7 -
Care & Maintenance .....	- 7 -
E-Label .....	- 8 -
Europe – EU Declaration of Conformity .....	- 9 -
Thailand Caution.....	- 10 -
<b>RELEASE NOTES</b> .....	<b>- 11 -</b>
<b>INTRODUCTION</b> .....	<b>17</b>
Features.....	18
Inside the Package .....	18
Accessories.....	18
Related Documentation.....	18
<b>QUICK START</b> .....	<b>19</b>
1.1. Overview .....	20
1.1.1. Installing/ Removing Battery.....	21
1.1.2. Installing SIM Card, SAM Card and Memory Card .....	23
1.1.3. Power On/Off Mobile Computer .....	25
1.1.4. Homescreen Selection .....	26
1.1.5. Using Hardware Buttons .....	27
1.1.6. Connecting Headset.....	27
1.2. Charging & Communication .....	28
1.2.1. Charge Mobile Computer .....	28
1.2.2. Wired Data Transmission .....	32
1.2.3. Using Wireless Networks.....	32

---

<b>USING THE RS51 MOBILE COMPUTER.....</b>	<b>33</b>
2.1. Battery.....	34
2.1.1. Battery Status Indicators.....	35
2.1.2. Monitor Battery Level.....	37
2.1.3. Replace Main Battery.....	41
2.1.4. Power Management.....	43
2.1.5. Battery Temperature Anomaly.....	45
2.2. Memory.....	46
2.2.1. Check Memory Usage.....	47
2.2.2. Manage Storage Space.....	49
2.3. Touch Screen.....	57
2.3.1. Screen Brightness.....	57
2.3.2. Screen rotation.....	58
2.3.3. Screen Timeout Settings.....	61
2.3.4. Text Size & Display Size.....	62
2.4. Notifications.....	63
2.4.1. Status LED.....	63
2.4.2. Audio.....	64
2.4.3. Sounds and Vibration.....	64
2.5. Date and Time.....	67
2.6. Language & Keyboard Input.....	69
2.6.1. Change Display Language.....	69
2.6.2. On-screen Keyboard.....	71
2.7. Sound and Volume.....	82
2.8. Button Assignment.....	83
2.9. Data Capture.....	89
2.9.1. Barcode Reader.....	89
2.9.2. Digital Camera.....	89
<b>BASIC OPERATION.....</b>	<b>90</b>
3.1. Home Screen.....	91
3.1.1. Customize Home Screen.....	91
3.2. Status Bar.....	94
3.2.1. Icons on Status Bar.....	94
3.2.2. Open Quick Settings Menu.....	96
3.2.3. Open Notifications Drawer.....	99
3.3. Manage Applications.....	102
3.3.1. Application Menu.....	102
3.3.2. Current Applications.....	105
3.4. Suspend & Lock.....	106

---

---

3.4.1.	Suspend Device.....	106
3.4.2.	Lock Device .....	106
3.5.	OS Update .....	108
3.6.	Back up Your Data.....	110
3.7.	Reset to Factory Default.....	112
3.7.1.	Erase All Data (Factory Reset).....	112
3.7.2.	Erase All Data (Factory Reset with Enterprise).....	114
3.7.3.	Welcome Wizard.....	115
<b>WIRELESS RADIOS.....</b>		<b>117</b>
4.1.	Use Wireless Wide Area Network .....	118
4.1.1.	Share WWAN Data.....	120
4.1.2.	Data Connection Settings.....	129
4.1.3.	SIM Card Settings.....	131
4.2.	Use Wireless Local Area Network (Wi-Fi).....	133
4.2.1.	Connect to Wi-Fi Network .....	133
4.2.2.	Manually Add Wi-Fi Network.....	135
4.2.3.	Wi-Fi Preferences .....	137
4.2.4.	Configure Proxy Server .....	139
4.2.5.	Use Static IP Address .....	139
4.2.6.	Connect With Wi-Fi Protected Setup (WPS).....	140
4.2.7.	Modify Wi-Fi Network.....	141
4.2.8.	Disconnect Wi-Fi Network .....	141
4.3.	Use Bluetooth.....	142
4.3.1.	Bluetooth Profiles.....	142
4.3.2.	Turn On Bluetooth .....	143
4.3.3.	Change Bluetooth Name .....	145
4.3.4.	Pair Bluetooth Devices.....	146
4.3.5.	Unpair Bluetooth Device.....	147
4.4.	Use Near Field Communications.....	148
4.4.1.	Pair with NFC Enabled Bluetooth Devices.....	149
4.4.2.	Share Information .....	149
4.4.3.	Communication with NFC.....	149
<b>USING THE PHONE.....</b>		<b>150</b>
5.1.	SIM Card Management .....	151
5.2.	Phone Application .....	154
5.2.1.	Phone Interface.....	154
5.2.2.	Place Call.....	156
5.2.3.	During A Call.....	157
5.2.4.	Receive Incoming Call .....	159
5.2.5.	Check Missed Calls .....	159

---

---

5.2.6.	Call History .....	160
5.2.7.	Call Settings .....	161
5.2.8.	Make Multi-Party Calls.....	162
5.3.	Audio Modes.....	163
5.4.	In-call Volume .....	164
<b>USING READER CONFIGURATION UTILITY .....</b>		<b>165</b>
6.1.	ReaderConfig Profile Management.....	166
6.1.1.	ReaderConfig Main Menu .....	167
6.1.2.	Profile Menu .....	172
6.2.	Configuring Reader.....	175
6.2.1.	General Settings.....	175
6.2.2.	Symbology .....	181
6.2.3.	Profile .....	183
6.2.4.	Reset .....	186
6.3.	Read Printed Barcodes .....	187
<b>SPECIFICATIONS .....</b>		<b>189</b>
	Platform, Processor & Memory .....	189
	Communication & Data Capture .....	190
	Electrical Characteristics .....	191
	Physical Characteristics .....	191
	Environmental Characteristics.....	192
	Programming Support.....	193
<b>APPENDIX I .....</b>		<b>194</b>
	Scan Engine Settings.....	194
	Symbologies Supported .....	194
<b>APPENDIX II .....</b>		<b>196</b>
	2D Imager .....	196
	Symbology Settings.....	196
	Symbology Settings (for SM2).....	207
<b>APPENDIX III .....</b>		<b>218</b>
	Open Source License .....	218



## INTRODUCTION

---

The **RS51** mobile computer, powered by Android 8.1 Oreo, is light-weight, easy to use, providing powerful and handy tools for the purpose of delivering flexibility in customization.

Specifically designed to work as an industrial PDA, it provides rich options of data collection, voice and data communication, long-lasting working hours, and so on. Its large color capacitive display guarantees ease in reading in all lighting conditions. Integrated with Bluetooth Class II, v4.1 and v2.1+EDR, 802.11 b/g/n and 802.11 a/ac/n technologies, the mobile computer also includes a GSM/GPRS/EDGE/WCDMA/HSPA/HSPA+/LTE CAT 6 module to gain greater speeds and optimal mobility. In particular, an integrated GPS receiver is made available for use with third-party location-based applications.

This manual serves to guide you through how to install, configure, and operate the mobile computer. The [Care & Maintenance](#) section is specifically crucial for those who are in charge of taking care of the mobile computer.

We recommend you to keep one copy of the manual at hand for quick reference or maintenance purposes. To avoid any improper disposal or operation, please read the manual thoroughly before use.

## FEATURES

- ▶ Built tough to survive drop test and sealed against moisture/dust to industrial standard IP65/67.
- ▶ Android 8.1 Oreo operating system with a powerful Cortex 1.3 GHz Quad-Core processor
- ▶ 16GB eMMC flash memory to store OS and software programs
- ▶ 2GB LPDDR3 SDRAM to store and run programs, as well as store program data
- ▶ One expansion slot for microSDHC card up to 32GB and microSDXC card up to 64GB.
- ▶ Built-in 13 megapixels rear camera with white LED for flash and auto focus.
- ▶ One side trigger for scanning
- ▶ Total wireless solution — connectivity includes Bluetooth Class II, v4.1 and v2.1+EDR (2402~2480 MHz: 3.3dBm), 802.11 b/g/n and 802.11 a/ac/n networking, GSM/GPRS/EDGE/WCDMA/HSPA/HSPA+/LTE CAT6.
- ▶ A 4.7" color transmissive display with 720x1280 pixels to deliver excellent visibility in all lighting conditions
- ▶ Configurable feedback indicators including speaker and vibrator
- ▶ Built-in scan engine setting tool Reader Configuration which serves out-of-the-box keyboard wedge functionality
- ▶ Accessories and peripherals include Snap-on Charging Cable and Charging Cradle (both are capable of USB Charging and Data Transfer)

## INSIDE THE PACKAGE

The following items are included in the kit package. Save the box and packaging material for future use in case you need to store or ship the mobile computer.

- ▶ RS51 Mobile Computer
- ▶ Rechargeable Li-ion battery pack
- ▶ Hand Strap
- ▶ Micro USB Charging and Data Transfer Cable
- ▶ Snap-on Charging Cable
- ▶ AC Power Adaptor
- ▶ Quick Start Guide

## ACCESSORIES

- ▶ Handbelt
- ▶ Charging cradle

## RELATED DOCUMENTATION

Log in to **GoBetween** to access related documentation about the RS51 mobile computer from the CipherLab Central Service (CCS) platform. Download the **GoBetween desktop** or mobile device application, or launch the GoBetween Lite web application from the following site: <http://ccs.cipherlab.com/>.

# Chapter 1

## QUICK START

---

This chapter helps you get ready for starting using the mobile computer.

### IN THIS CHAPTER

---

1.1 Overview .....	20
1.2 Charging & Communication .....	28

1.1. OVERVIEW

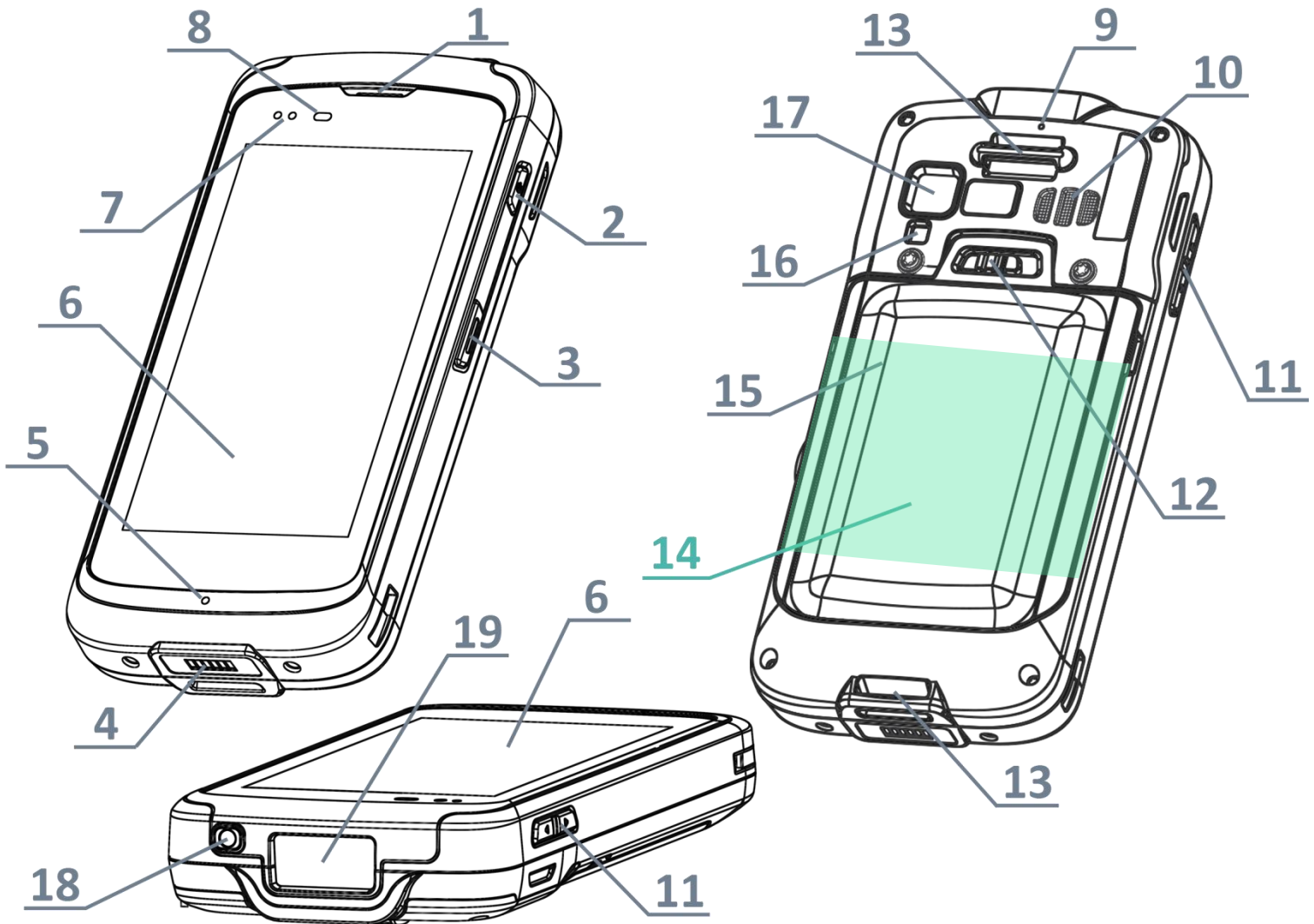

No.	Description	No.	Description
1	Phone Receiver	2	Power Button
3	Side Trigger Key	4	Charging & Commnuication Port
5	Microphone	6	Touch Screen
7	Status LEDs	8	Light Sensor & Proximity Sensor
9	Rear Microphone	10	Loudspeaker
11	Volume Keys	12	Battery Latch
13	Hand Strap Hole	14	NFC Detection Area
15	Battery (with Cover)	16	CameraFlash
17	Camera Lens	18	Headset Jack
19	Scan Window		

### 1.1.1. INSTALLING/ REMOVING BATTERY

For shipping and storage purposes, the mobile computer and the main battery are saved in separate packages.

**Note:** Any improper handling may reduce the battery life.

#### INSTALL MAIN BATTERY

To install the main battery, please:

- 1) Insert the main battery with the contact pins facing the lower end. Fix the lower edge of the battery first.
- 2) Then push down the upper end. The battery latch will fit into place with a click sound.

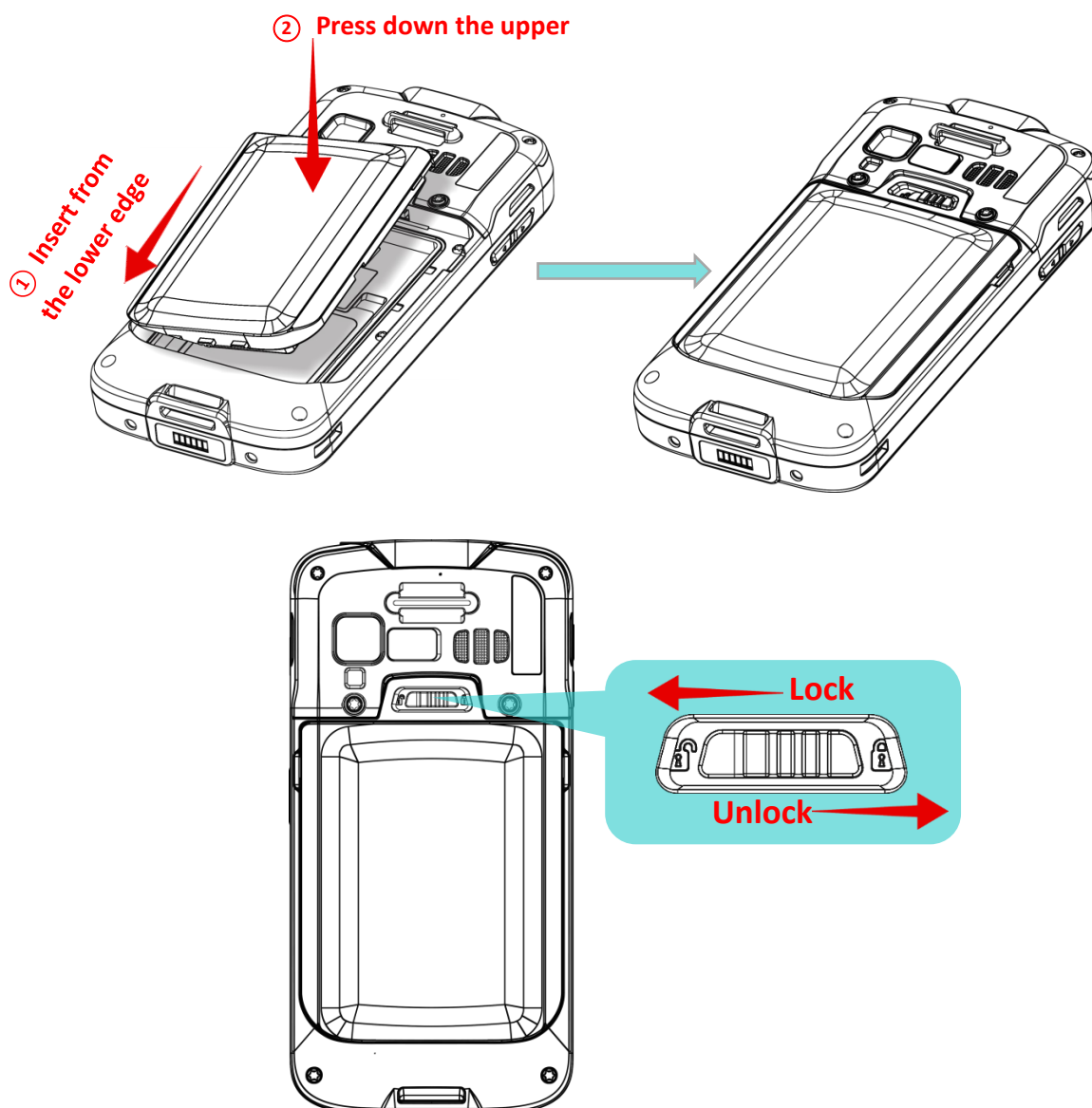

## IMPORTANT CHARGING INFORMATION

<b>Power Adaptor</b>	Input: AC 100-240V, 50-60Hz; output: 5V/2A CipherLab approved
<b>Battery Pack</b>	3.8V 4000mAh/3.75V 5300mAh (Standard/Extended) rechargeable Li-ion CipherLab proprietary
<b>Charging time</b>	Approx. 4 hours via adaptor at 25°C For the first time charging the main battery, please charge it for at least 8 to 12 hours.

### Note:

For initial use, insert a charged battery, and then press the Power key to power on the mobile computer.

## REMOVE BATTERY

- 1) Shut down this device first.
- 2) Slide the key latch rightwards; the battery will be unlocked with a click sound.
- 3) Lift the battery up from its upper end.

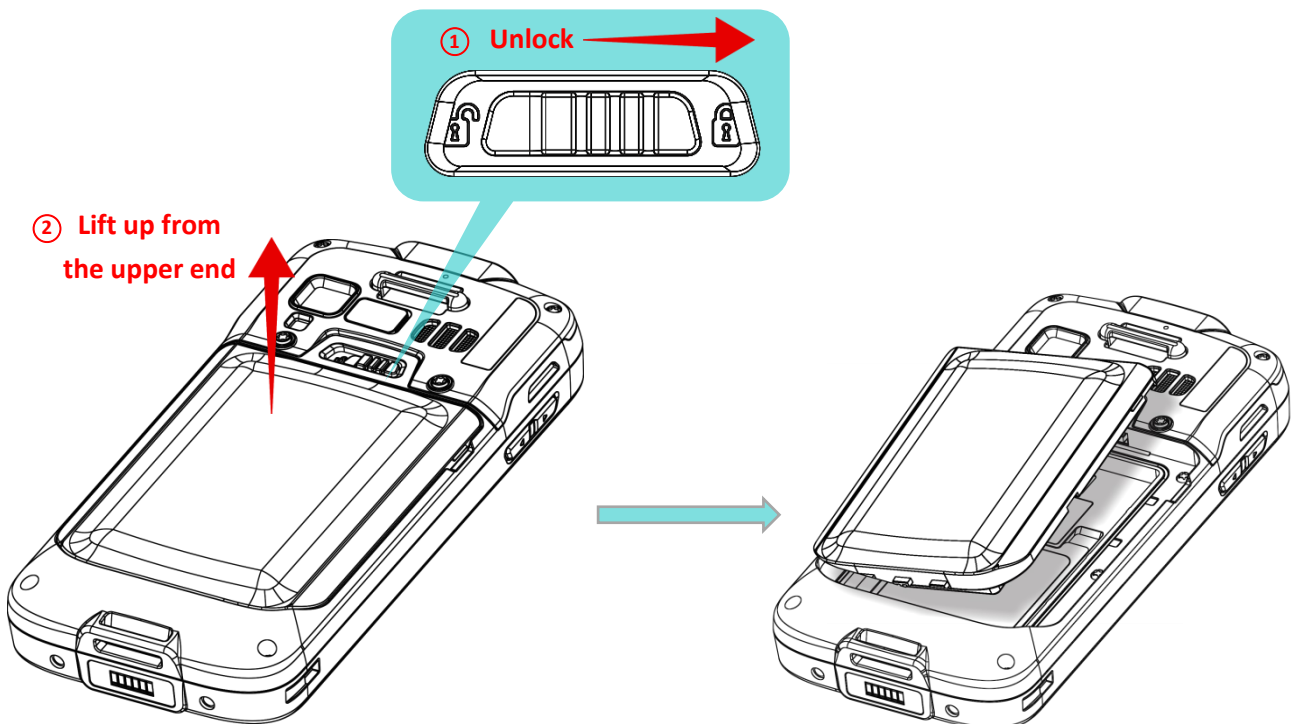

### 1.1.2. INSTALLING SIM CARD, SAM CARD AND MEMORY CARD

The RS51 mobile computer is equipped with two SIM card slots, one SAM card slot and one memory card slot.

**Note:** SIM/SAM card slots are with no function for Wi-Fi only model.

To insert the cards:

- 1) Remove the battery as described in [Remove Battery](#).
- 2) Insert your fingernail into the notch above the inner lid that protects the card sockets chamber, and lift it up.

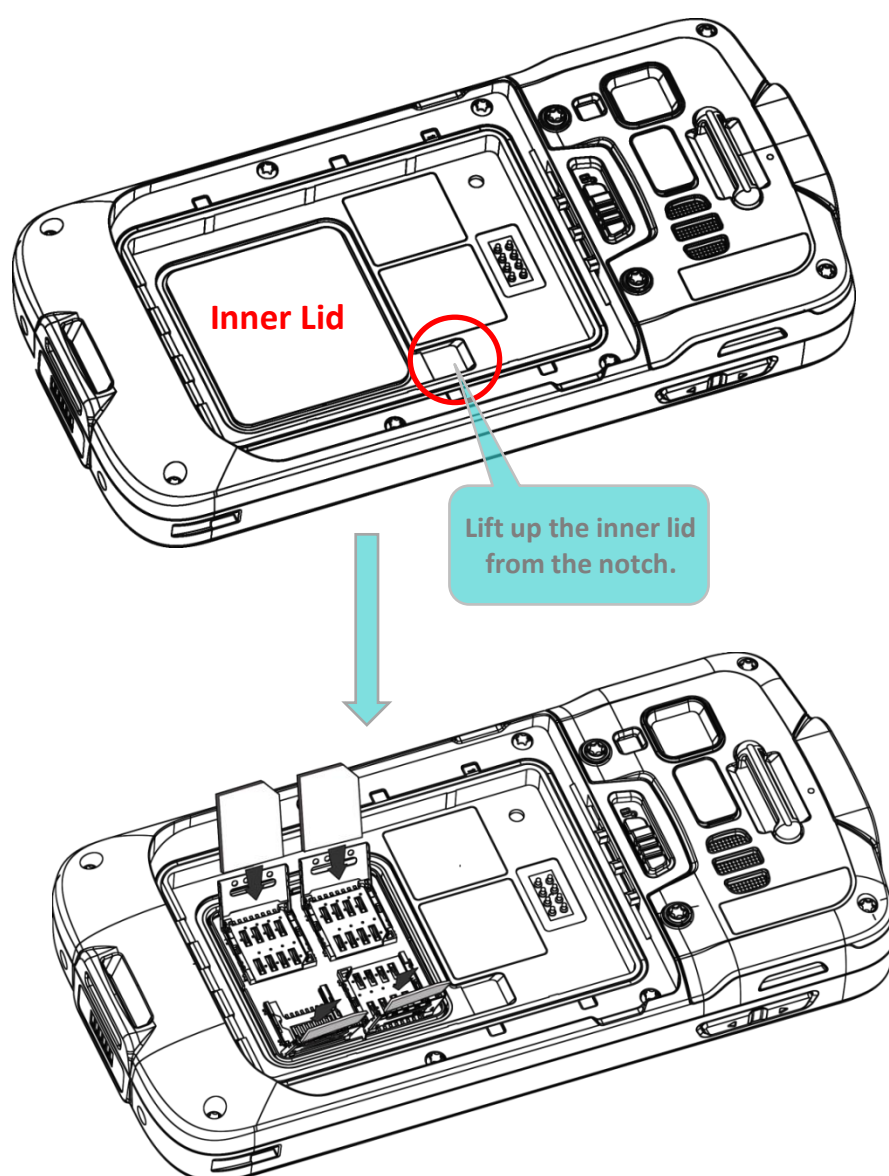

- 3) After the chamber is revealed, insert SIM cards, the SAM card and the microSD card into their respective sockets. Close and push back the hinged cover till a click sounds.

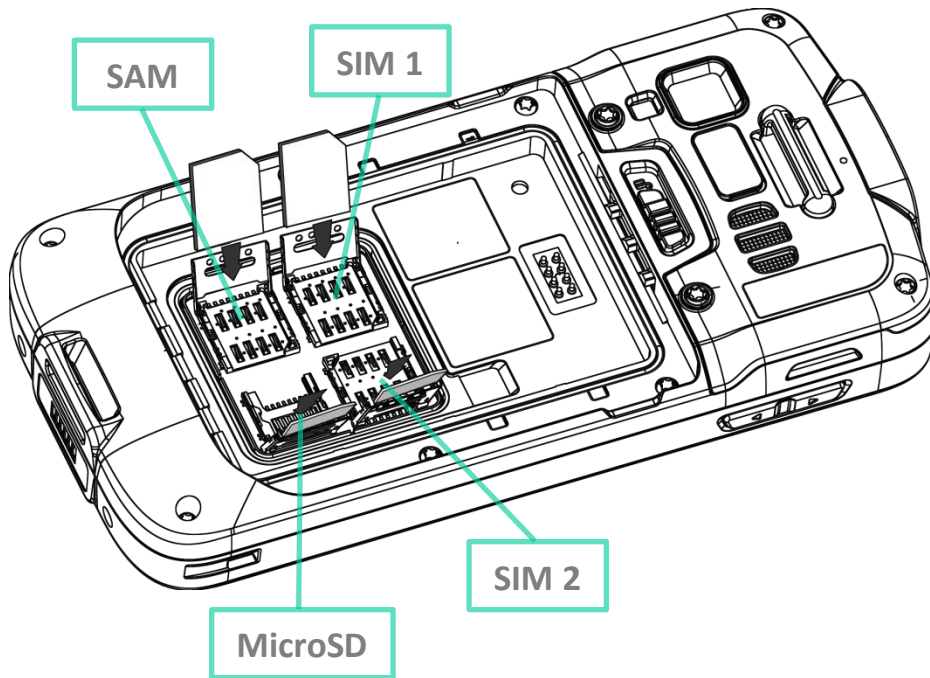

**To Install the Cards:**

- 1) Slide the hinged cover back.
- 2) Swing the top to open.
- 3) Insert the cards, close the hinged cover, and then push it back.

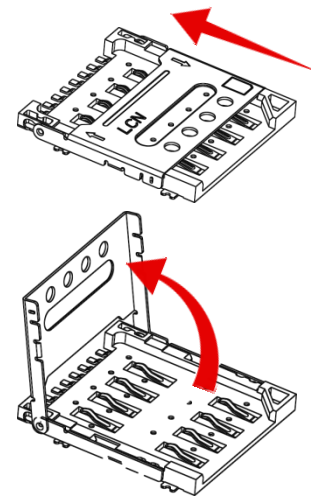

- 4) Place the inner lid back.
- 5) Place the battery back.

**Note:**

- 1) Both SIM1 and SIM2 card slots support 2G/3G/4G cards. However, you can have 3G/4G data transmission on either SIM but not on both at the same time. Refer to [SIM Card Management](#) for details on managing dual SIM cards.
- 2) SIM/SAM card slots are with no function for Wi-Fi only model.

**REMOVE CARDS**

- 1) Remove the battery.
- 2) Remove the inner lid.
- 3) Unlock the card hinge cover and remove the card.
- 4) Mount the inner lid and the battery.



### 1.1.3. POWER ON/OFF MOBILE COMPUTER

#### POWER ON

To power on the mobile computer, press and hold the power button  located on the upper right side of the device. The mobile computer will turn on and show the [Home Screen](#) after splash screen.

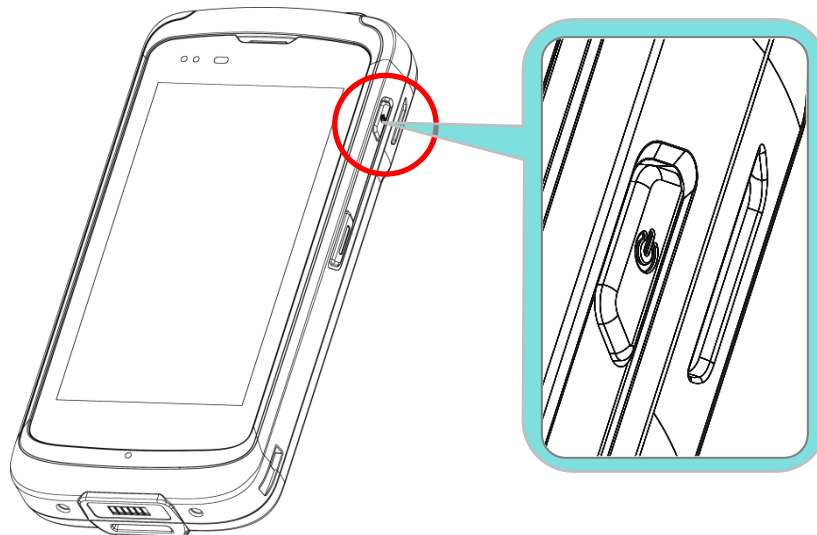

**Note:** For the mobile computer to power on, the battery cover must be secured in place.

#### POWER OFF

To power off the mobile computer, press and hold the power button  for more than three seconds. A menu will appear on-screen which allows you to power off the device. Make sure all user data and tasks have been stored before tapping on **Power off**.

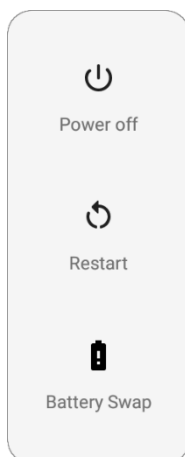



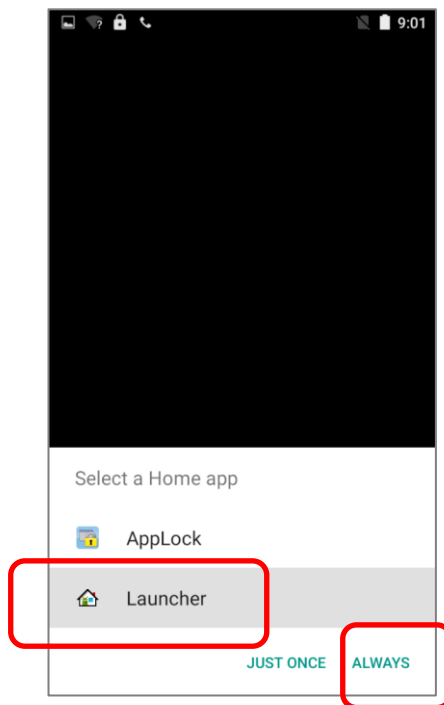

### 1.1.4. HOMESCREEN SELECTION

Upon the first time you launch the system, a **Select Home app** window will pop up to request your immediate choice of home screen. By selecting "**AppLock**", you will directly enter AppLock application (please refer to *AppLock User Guide* for detailed instructions on AppLock settings) to start configuring the interface provided to normal users of this device; by selecting "**Launcher**", you will enter the default Android 8.1 home screen.



### 1.1.5. USING HARDWARE BUTTONS

On the bottom of the mobile computer are three hardware buttons that deliver the following functions:

Button	Function	Description
	<b>Back button</b>	Returns to the previous screen or closes the active window or keyboard.
	<b>Home button</b>	Displays the Home screen.
	<b>Recent apps button</b>	Opens a list of recently used applications.
	<b>Search button</b>	Performs Google™ search online

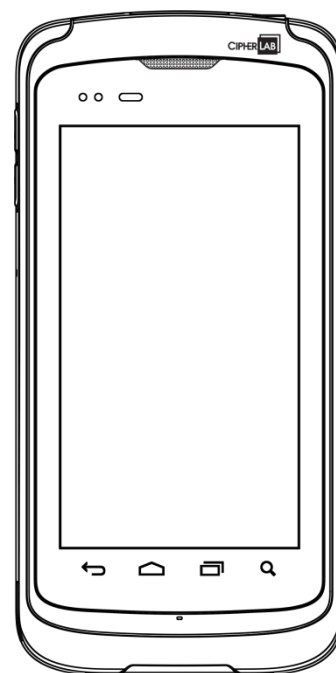

### 1.1.6. CONNECTING HEADSET

The headset jack is located on the top of the mobile computer. You can use the headset for audio playback or communication via the phone application, audio instant messaging, etc.

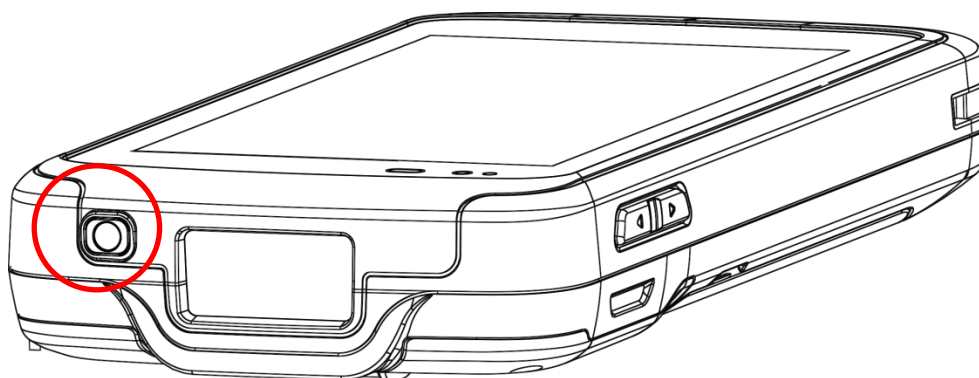

---

## 1.2. CHARGING & COMMUNICATION

### 1.2.1. CHARGE MOBILE COMPUTER

The main battery may not be charged to full for shipment. When you first receive the kit package, you will need to charge the main battery to full before using the mobile computer. You may use the Snap-on Charging Cable or Charging Cradle along with a power adapter to charge the mobile computer.

Your device can be charged as well when connected to a computer via USB cable; however, charging from a USB port on a computer is slower than charging using the Snap-on Charging Cable/Charging Cradle (all powered by the AC power adaptor).

---

#### CHARGING TIME

▶ **Main battery:**

The main battery powers the mobile computer to work. It takes approximately 4 hours to charge an empty main battery to full. For the first time charging the main battery, please charge it for at least 8 to 12 hours. The charging LED above the screen (located on the right) will light up in red while charging and will turn green when charging is complete.

When the main battery is removed, RTC retention will be maintained for at least 30 minutes.

▶ **Backup battery:**

The backup battery is mounted on the main board. Its role is to temporarily keep the mobile computer in suspension when the main battery is drained out so data in DRAM will be retained. The backup battery takes approximately 3.5 hours to charge to full by the main battery or power adapter.

---

#### CHARGING TEMPERATURE

The allowed battery charging ambient temperature is between 0°C to 40°C. It is recommended to charge the battery at room temperature (18°C to 25°C) for optimal performance.

Please note that battery charging stops when ambient temperature drops below 0°C or exceeds 40°C.

---

#### OPERATION ON BATTERY POWER

- ▶ When 802.11a/b/g/n/ac, GSM/GPRS/EDGE/WCDMA/HSPA/HSPA+/LTE CAT 6, Bluetooth v4.1 & v2.1+EDR and GPS are all enabled on battery power, the main battery level will drop down substantially. Prolonged use of the display and continued scanning of barcodes will also affect battery level.
- ▶ In order to prevent system from shutting down after the battery is drained out, we suggest that you keep a fresh battery for replacement at all times, or connect the mobile computer to an external power.

## USE SNAP-ON CHARGING CABLE

The Snap-on Charging Cable provides a convenient way to charge your mobile computer.

- 1) Fasten the Snap-on Charging Cable to the lower end of the mobile computer.
- 2) Connect the other end of the cable to a USB port or the adaptor.
- 3) Fix the adapter plug onto the adapter, and plug in into an electrical outlet.

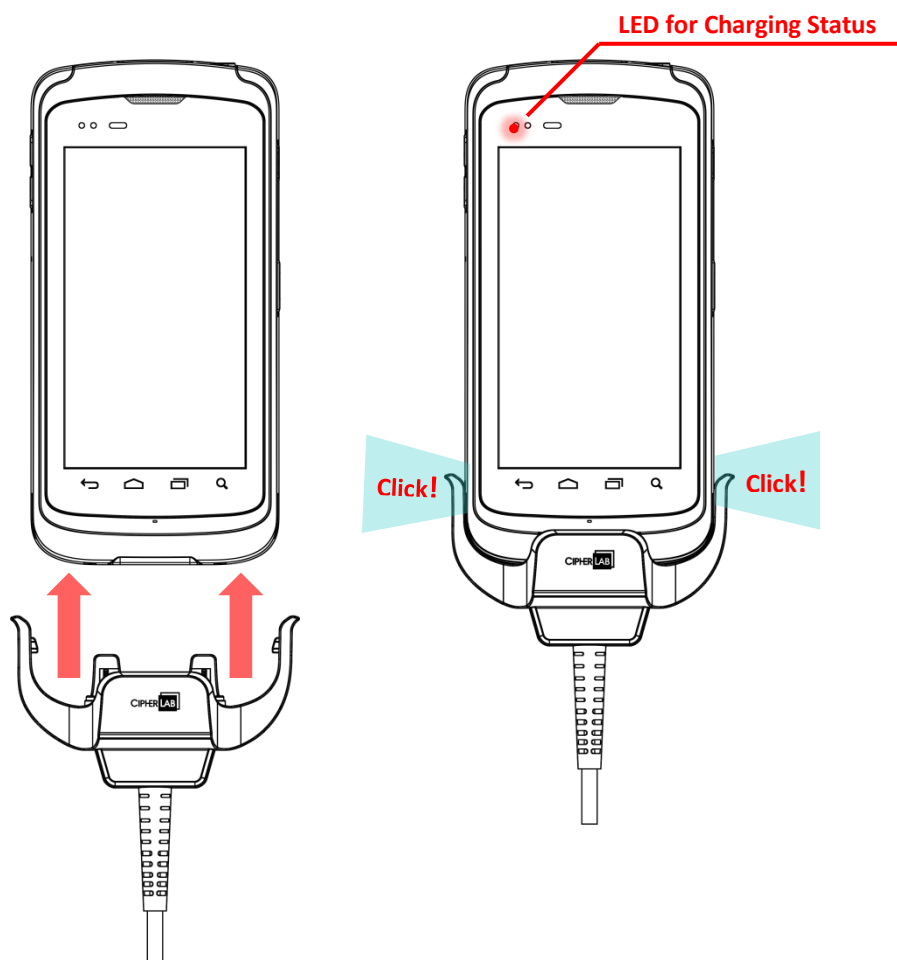

While the device battery is being charged, the LED indicators on mobile computer will indicate charging status.

LED Indicator	Status	Description
Charging Status	Red, solid	Charging in progress
	Red, blink	Charging error
	Green, solid	Charging completes
	No light	The cable is not correctly connected

---

## USE CHARGING CRADLE

The Charging Cradle can charge your mobile computer and a spare battery at the same time:

- ▶ Presents charging compartment for mobile computer and spare battery
- ▶ Provides micro USB socket on the back for charging
- ▶ Supports USB Host Mode via a USB OTG cable
- ▶ Completes charging in approximately 5 hours
- ▶ Adapter input AC 100-240V, 50/60Hz; output DC 5V, 2A.

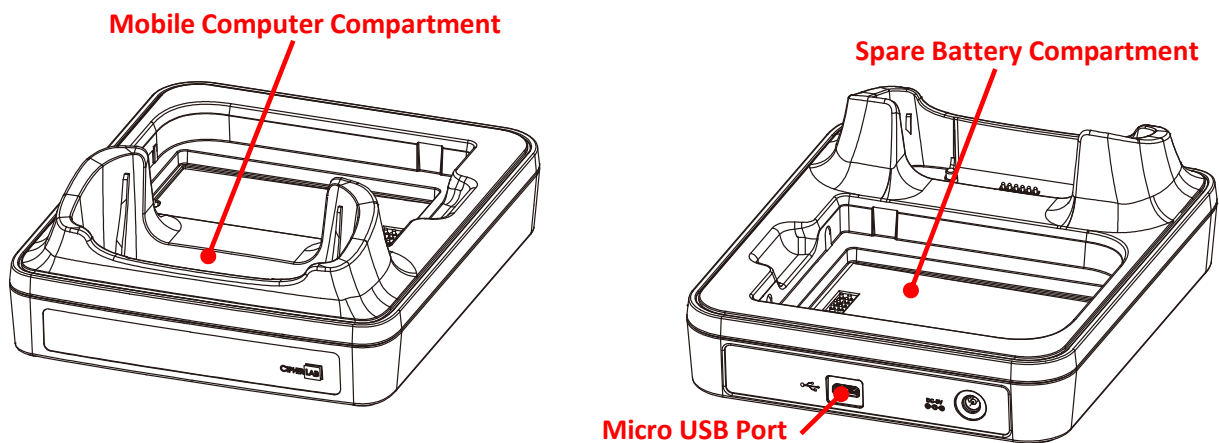

To charge your mobile computer via the Charging Cradle:

- I) Smoothly insert the mobile computer into the Charging Cradle.

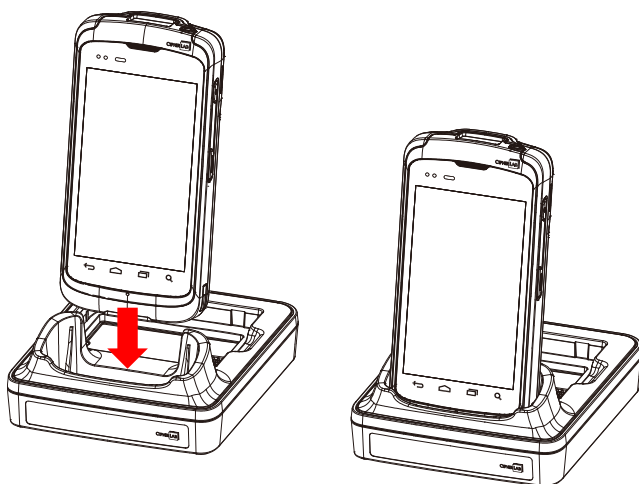

- 2) Connect the adapter to the Cradle, and plug the other end into an electrical outlet.

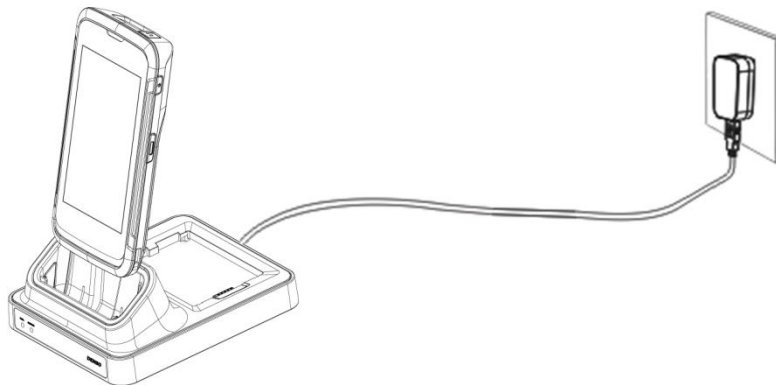

The status of the mobile computer charging is shown on the device itself; while the LED indicator on RS51 Charging Cradle shows the status of battery charging as below:

Cradle LED Indicator	Status	Description
Charging	Red, solid	Charging the battery
	Red, blink	Charging error
	Green, solid	Charging completes
	No light	Not charging

---

**Note:**

- (1) ***Not Charging*** could be the result of battery damage, battery's failure to touch the connector, or AC plug coming off.
  - (2) **Charging error** could be due to high battery temperature.
-

## 1.2.2. WIRED DATA TRANSMISSION

Use the Snap-on cable to connect the mobile computer to your PC for data transmission.

- 1) Connect your device to the computer with the supplied Snap-on cable.

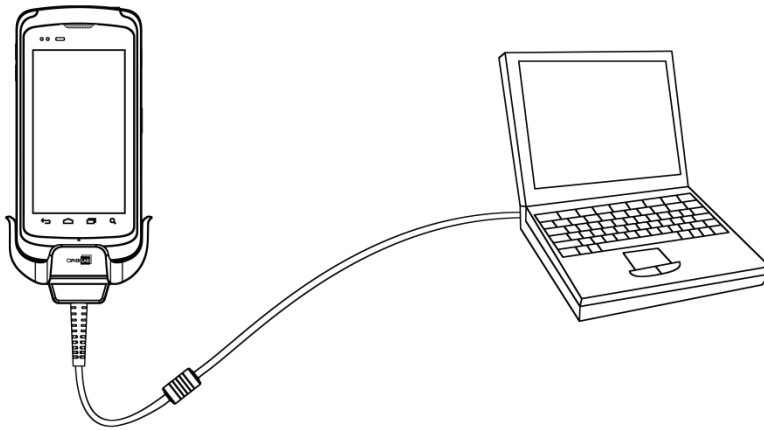

- 2) Swipe down from the status bar to reveal Notifications Drawer.
- 3) Tap "**USB charging this device**" to enter USB options. "**Transfer files**" is set by default to transfer all types of files between your device and PC. To transfer videos and photos, you can select "**Transfer photos (PTP)**", in which your device will share only videos and photos in DCIM and Pictures folders. Choosing "**Charging this device**", the device will be in charging mode, in which you are unable to access the files on this device from the PC client.

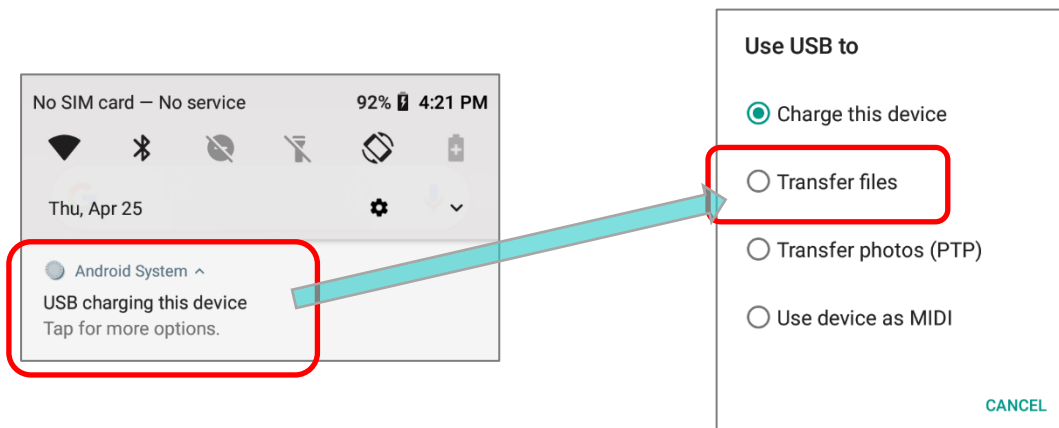

## 1.2.3 USING WIRELESS NETWORKS

The mobile computer supports widely applied wireless technologies including Bluetooth v4.1 & v2.1+EDR, 802.11 a/b/g/n/ac, and is able to send/receive data in real time in an efficient way. Select GSM/GPRS/EDGE/WCDMA/HSPA/HSPA+/LTE CAT 6 modules embedded for a total wireless solution for data and voice communication.



## Chapter 2

### USING THE RS51 MOBILE COMPUTER

---

This chapter walks you through the fundamental usage and features of this device.

#### IN THIS CHAPTER

---

2.1 Battery .....	34
2.2 Memory .....	46
2.3 Touch Screen .....	57
2.4 Notifications .....	63
2.5 Date and Time .....	67
2.6 Language & Keyboard Input .....	69
2.7 Sound and Volume .....	82
2.8 Button Assignment .....	83
2.9 Data Capture .....	89

## 2.1. BATTERY

### ▶ **Main Battery**

The mobile computer is powered by a rechargeable 3.8V / 4000 mAh or 3.75V / 5300 mAh Li-ion battery pack. It takes approximately 4 hours to charge it to full from the power adaptor (for the first time charging the main battery, please charge it for at least 8 to 12 hours). However, the charging time may vary by your working condition.

### ▶ **Spare Battery**

A spare battery pack is provided as an accessory. We recommend keeping a fully charged spare battery at hand in order to replace the main battery when it is nearly drained out.

### ▶ **Backup Battery**

Settled on the main board is a backup battery that keeps the mobile computer in suspension when the main battery is depleted. The backup battery is a 60 mAh rechargeable Li-ion battery, and can retain data in the DRAM for 30 minutes when it is fully charged (as long as wireless modules on the mobile computer are inactive). The backup battery can be charged by the main battery or the power adapter, and takes approximately 3.5 hours to charge to full.

---





#### **Warning:**

- (1) The battery must be secured in position. If not, the mobile computer cannot turn on by pressing the power key.
  - (2) For a new battery, make sure it is fully charged before using, and for the first time charging the main battery, please charge it for at least 8 to 12 hours
  - (3) To avoid data loss, when replacing the main battery, make sure you replace it with a well-charged spare battery pack. Always prepare a spare battery at hand, especially when you are on the road. When the mobile computer has been on backup battery for 30 minutes, the system will shut down. Be sure to replace the main battery as soon as possible in order to avoid data loss.
-

### 2.1.1. BATTERY STATUS INDICATORS

The main battery pack is the only power source for the mobile computer to work. Therefore, when the main battery level goes low, you need to replace the battery pack with a charged one or charge it as soon as possible. Most of all, you should backup important data on a regular basis.

By checking the battery status icon on **Status Bar**, you can tell the battery level remaining in the main battery.



Battery Icon	Description
	Main battery is fully charged.
	Main battery level is partially drained.
	Main battery level is low (5%~15%).
	Main battery level is very low and needs charging immediately (<5%).
	External power source is connected and main battery is being charged.

To check the exact remaining percentage of power and battery life:

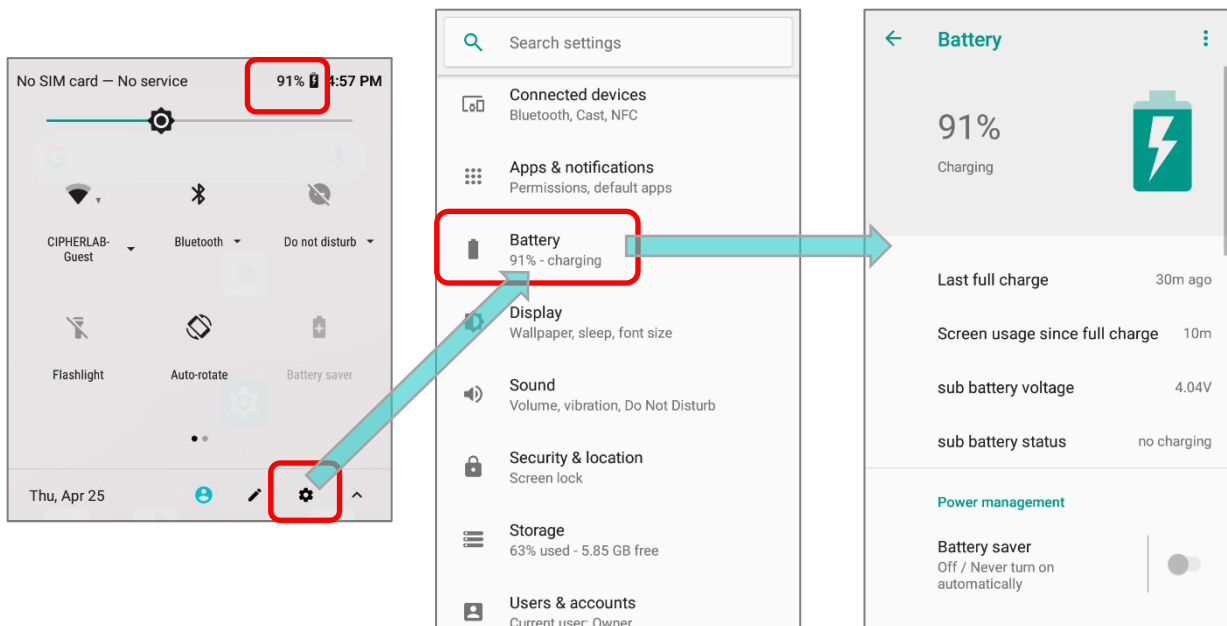
- 1) Use two fingers to swipe down from the top of the screen to open **Quick Settings**.
- 2) The percentage of remaining battery power is shown beside the battery icon; you can tap on the settings icon  to enter **Settings** page and tap on "**Battery**" page for more details and configurations.



**Note:**

When the mobile computer is fully charged and battery level reaches 100%, the battery icon will change from  to  to indicate charging is completed.

---

**Warning:**

- (1) Once the battery level drops below 15%, the low battery notification will be displayed on the screen.
  - (2) Data loss with RAM may occur when battery level is low. Always save data before the battery runs out of power or keep a fresh battery for replacement.
  - (3) Constant usage of the mobile computer at low battery level can affect battery life. For maximum performance, recharge the battery periodically to avoid battery drain out and maintain good battery health.
-

## 2.1.2. MONITOR BATTERY LEVEL

### MAIN BATTERY LEVEL

The main battery is the only source that feeds the mobile computer to work. It also supplies the backup battery on the main board in order to retain the data stored in DRAM. When main battery level gets low, recharge it or replace it as soon as possible. Most critically, back up the important data from time to time to protect your work.

To check main battery level:

Tap [App Drawer \(All Apps\)](#) | **Settings**  | **Battery**  .

Battery level percentage is shown to provide a clear grasp of the remaining battery power. Tap on it to enter “**Advanced battery usage**” page, the screen shows the rate of battery discharge since the last battery charging session, how long the device has been running on battery power, and which applications are consuming the most battery power.

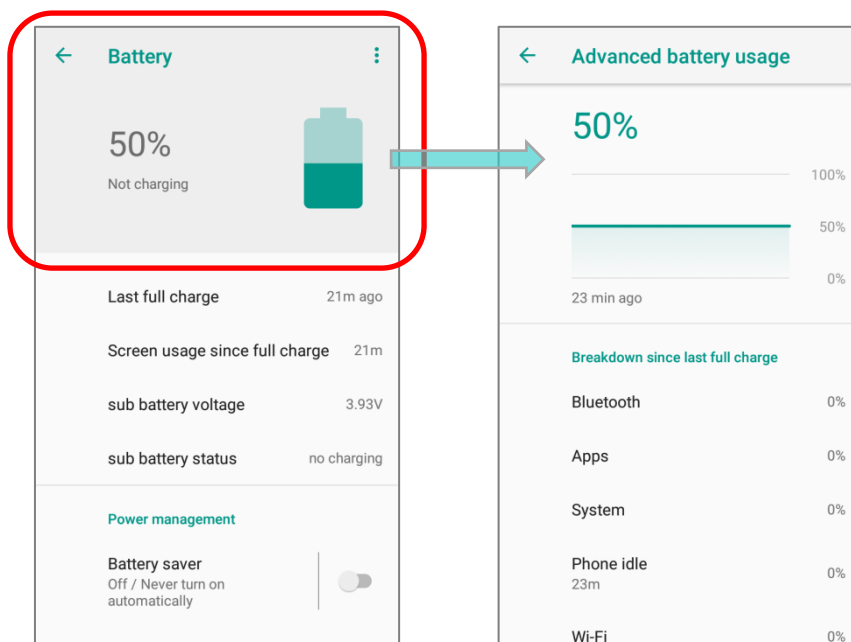

## BATTERY SAVER MODE

You can have the **Battery saver** mode automatically turned on when the main battery gets low. This mode will limit the use of location services, vibration and most background processing data. Once **Battery saver** is enabled, the title bar of your screen will turn red.

On **Battery** screen, simply switch on "**Battery saver**" or tap on it to enter "**Battery saver**" page to switch it on and set choose when to have this mode automatically activated.

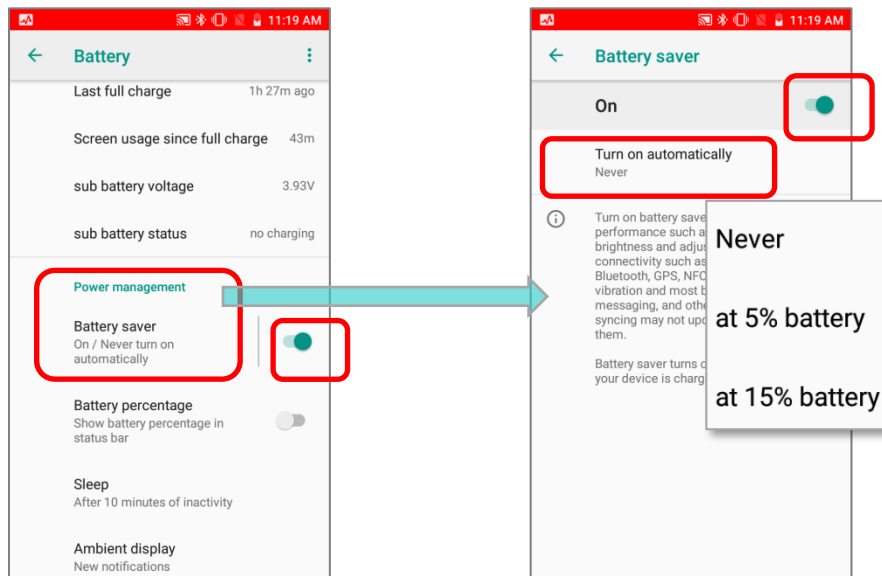

Also, you can swipe down from the status bar to reveal **Quick Settings Panel** or **Quick Settings Menu**, and tap the battery saver icon  to enable/ disable it.

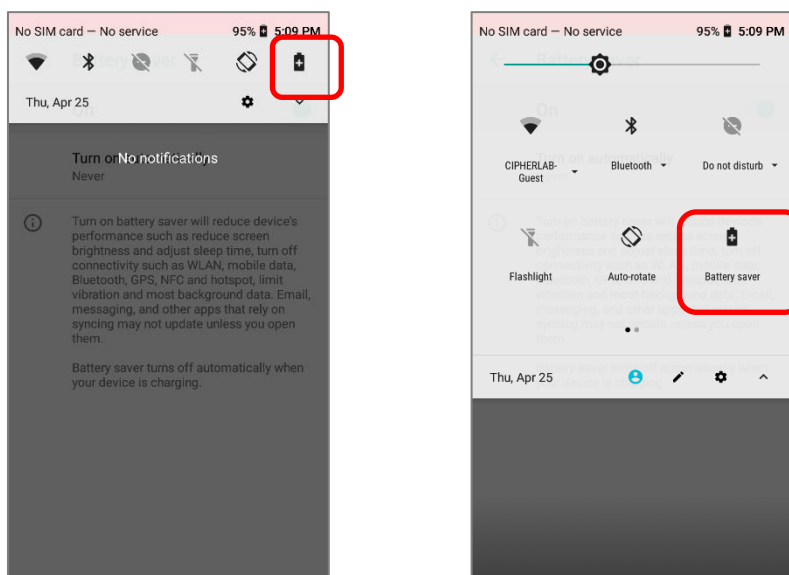

**Note:** This mode will automatically become inactive when your device is being charged.

## BATTERY OPTIMIZATION

With **Battery optimization** enabled for the applications, you can make sure they stay inactive when your device is idle or when they have not been used for days.

- 1) On **Battery** screen, tap **More**  and then select "**Battery optimization**".

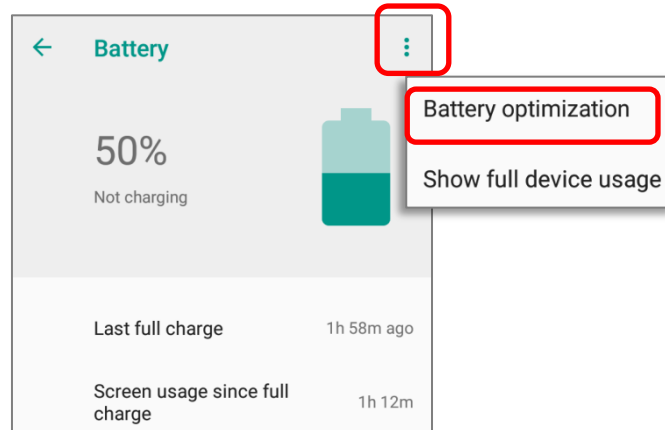

- 2) On the dropdown list, select "**All apps**", all the applications will be optimized by this function by default. You can individually turn off the optimization mode of a certain app if you would like it always activated by tapping on the app name and select "**Don't optimize**" and then "**DONE**".

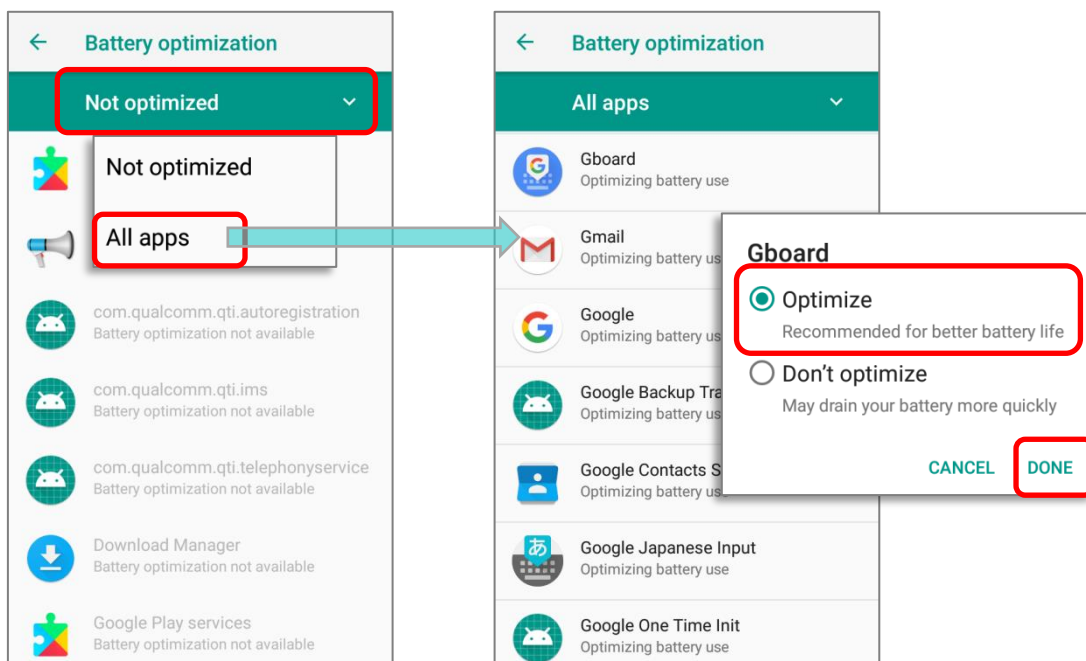

## LOW BATTERY ALERT

The mobile computer prompts a warning notification reminding you to charge the main battery when the main battery level drops to **15%** and **5%**. In the meantime, the device's status LED indicator will blink red.

Opening [Notifications Drawer](#), you will also see this warning appearing on the notifications list; you may turn on [Battery Saver Mode](#), connect the mobile computer to an external power source, or replace the main battery pack as soon as possible. To replace the main battery pack, see [Replace Main Battery](#).

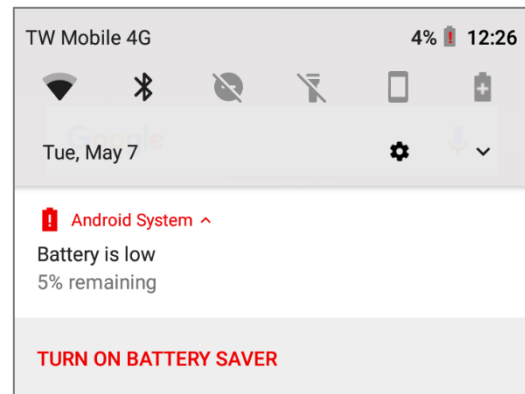
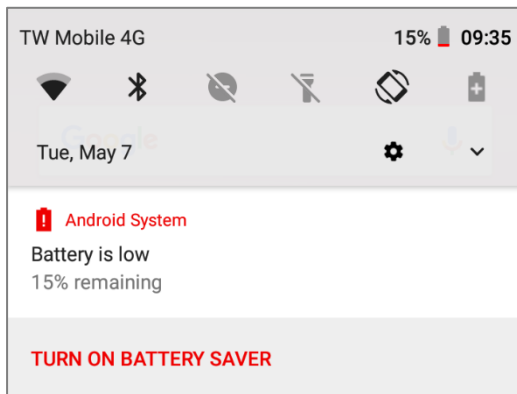

## LOW SUB BATTERY ALERT

When the main battery's power is drained out, RS51 mobile computer will automatically suspend by backup battery's power for **30** minutes. When backup battery's power is low, the "**Low Sub Battery**" notification will remind you to connect the device with an external power source to charge it immediately. Please note that do not replace the main battery at this moment, otherwise data loss may occur.

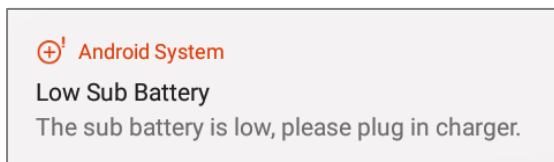



### 2.1.3. REPLACE MAIN BATTERY

When main battery level is low, follow the steps below to replace the main battery.

#### SHUT DOWN TO REPLACE THE MAIN BATTERY

Shut the device down to replace the main battery, please:

- 1) Make sure the sub battery (backup battery) and the new main battery are fully-charged.
- 2) Press and hold the [power button](#) on the side of the mobile computer.
- 3) Tap "**Power off**" in the pop-up menu. The mobile computer will power off.
- 4) Follow the steps as [Installing/ Removing Battery](#) describes to remove the main battery and replace it with the new one.

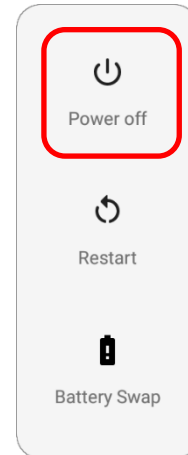

#### BATTERY SWAP

RS51 mobile computer's backup battery supplies system power during battery swap. When the battery (with cover) is removed, the system will enter suspend mode and not wake up until battery cover is put back and the power button is pressed. Please refer to "[Low Sub Battery Alert](#)" to make sure the sub battery is fully charged before battery swap process.

- 1) Press and hold the power button on the top end of the mobile computer, and select "**Battery Swap**" and then "**OK**" in the pop-up menus. The system will prepare to enter suspend mode with the red Status LED on the front panel lit.
- 2) Observe the red light on the front panel; as it goes off, the device is in complete suspend mode and Main battery is ready to be replaced. Follow the steps described in [Installing/ Removing Battery](#) to remove the battery and replace it with the new one.
- 3) When the main battery is removed, system can stay in suspend mode at least 5 minutes. Please replace with a fully-charged main battery as soon as possible.
- 4) Make sure the battery latch is properly locked before pressing the power button to wake up the mobile computer from suspend mode.

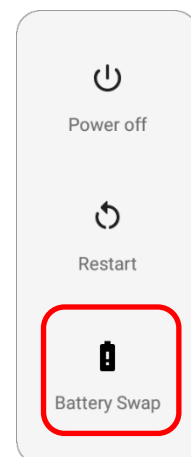

#### Warning:

Please do not perform a battery swapping before the mobile computer's OS is ready. Removing the battery cover during powering up your mobile computer may cause system failure.

**Note:**

- (1) “Battery Swap” is forbidden for the circumstance below:
  - a) during Welcome Wizard ;
  - b) within the 70 seconds after booting up including rebooting or factory reset.
  
- (2) When main battery is removed, the system will stay in suspend mode for at least 5 minutes. To prevent the system from being shut down without advance warning, please DO replace the main battery within the 5 minutes.
  
- (3) The system time will be set to default if the main battery is not replaced within 5 minutes.
  
- (4) Backup battery keeps the mobile computer in suspension when the main battery is depleted. Thus, to prevent data loss, DO NOT replace the main battery when backup battery’s power is low. Please connect RS51 mobile computer with the external power source to charge it till the “Low Sub Battery” notification icon disappears from the status bar. Once the “Low Sub Battery” notification disappears, the main battery replacement could be proceeded.

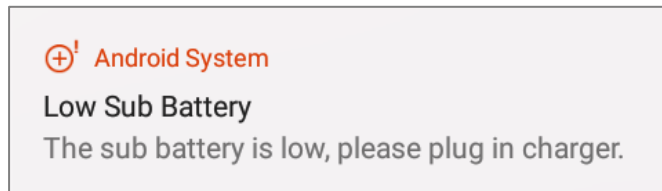





## 2.1.4. POWER MANAGEMENT

For any portable device, power management is a critical issue especially when you are on the road. Below are some tips to help you save battery power.

### Warning:

Using backlight, wireless connectivity, and peripheral devices on battery power will substantially reduce battery power.

- ▶ Bring an additional main battery pack with you on the road.
- ▶ End wireless connections (such as Bluetooth transmission, WLAN, WWAN, NFC and GPS) which are not in use.
- ▶ Shorten the time interval of turning off screen. See [Screen Timeout Settings](#).
- ▶ Reduce the screen brightness level, see [Screen Brightness](#).
- ▶ If you have had your Google account signed in on this device, you could turn off certain automatic data syncing of applications (such as Email, Calendar, and Contacts). Go to [App Drawer \(All Apps\)](#) | [Settings](#)  | [Users & Accounts](#)  | your **Google** account  | [Account sync](#)  and disable the data syncing services of your desired items.

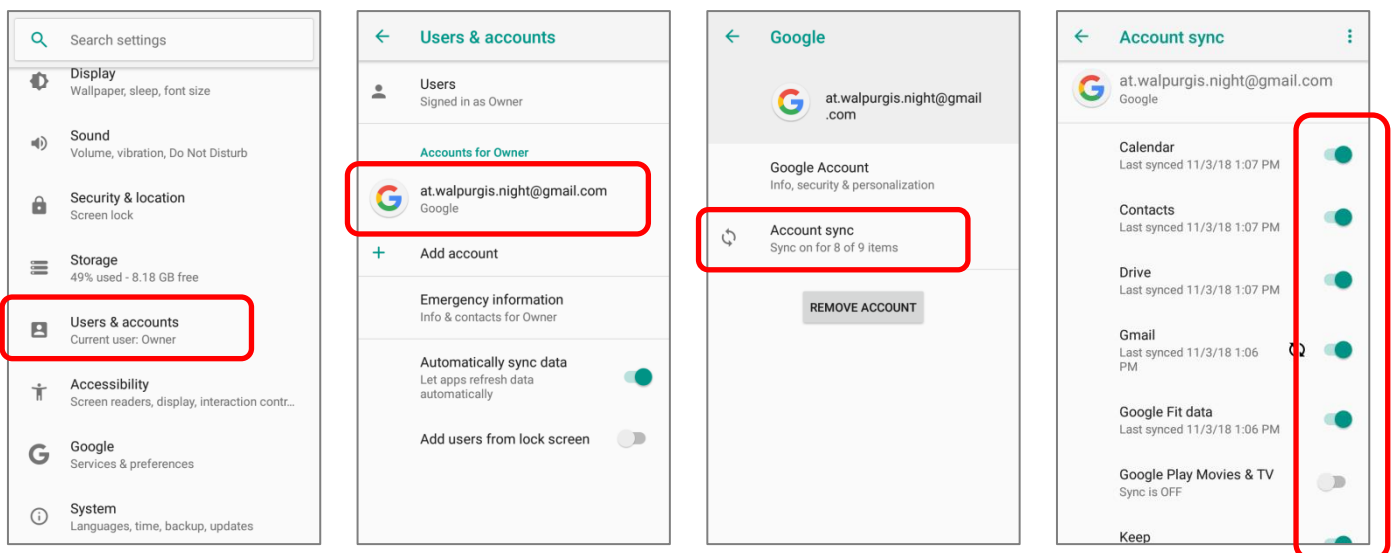

- ▶ Enable **Battery saver** mode and **Battery optimization** mode. See [Battery Saver Mode](#) and [Battery Optimization](#).

## ENTER AIRPLANE MODE

You can enable **Airplane** mode to have all the wireless radios (including call functions, data connections such as Bluetooth, Wi-Fi and 3G/4G) on your mobile computer turned off, which will considerably reduce the power consumption of your battery.

To enter **Airplane** mode:

- 1) Use two fingers to swipe down from the top of the screen to open **Quick Settings menu**.
- 2) Swipe the **Quick Settings menu** right or left to find the **Airplane mode** icon and tap on it to enable/disable it.

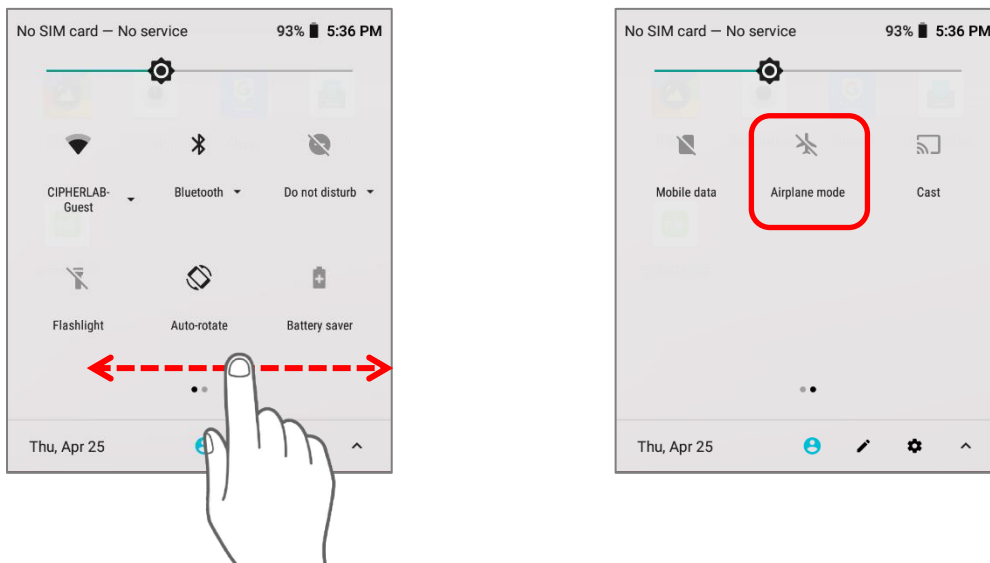

### 2.1.5. BATTERY TEMPERATURE ANOMALY

High ambient temperature or keeping using RS51 mobile computer while charging might results in battery temperature rises. RS51 mobile computer will automatically suspend charging battery or shut down for safety purpose. Once the battery temperature cools down to normal temperature, battery charging could be proceeded again.

Using RS51 mobile computer under low-temperature environment may cause the device shut down automatically. If the battery temperature is at **0°C** or even **lower than 0°C** while charging, the red Status LED in the front panel blinks with a warning window popup to remind the user to disconnect the charger, and RS51 mobile computer will automatically suspend charging the battery.

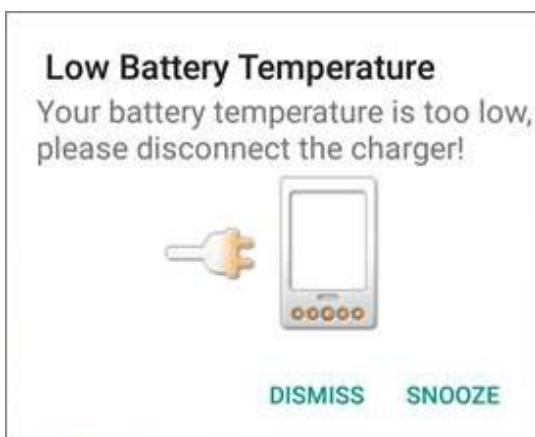

For battery life, please unplug the charger immediately and charge your RS51 mobile computer under appropriate temperature conditions.

## 2.2. MEMORY

▶ **Flash Memory (ROM)**

16GB flash memory for storing the OS (Android 8.1 Oreo) and custom application programs.

▶ **Random Access Memory (RAM)**

2GB RAM for storing and running programs, as well as storing program data.

▶ **Expansion Slot**

The mobile computer is equipped with one SD card slot which can accommodate a micro SD card, a microSDHC, or a microSDXC card. When choosing an SD card for best compatibility and performance with RS51, please make sure of the capacity you need. For the use of SDXC card, please use a new card and make sure it has not been used in other host devices (computers, cameras, or readers).

Card	Capacity
SDXC	64GB
SDHC	32GB

---

### CAUTION OF DATA LOSS

When the main battery is removed or drained, the backup battery on the main board takes over to supply the mobile computer and keep it in suspension. A fully charged backup battery will retain the data in the RAM for **30 minutes**. When the backup battery is drained out as well, the mobile computer will shut down, and only the contents of RTC will be retained. All other unsaved data will be lost.



If you want to put away the mobile computer for a couple of days, you should be aware that data loss occurs when the main battery and backup battery discharges completely. Therefore, it is necessary to backup data and files before putting away the mobile computer.

## 2.2.1. CHECK MEMORY USAGE

The memory manager can offer a glance of how the device is using its RAM.

### ENABLE DEVELOPER OPTION

To check the memory usage, you have to enable "**Developer Option**" :

- 1) Go to [App Drawer \(All Apps\)](#) | **Settings**  | **About Phone**.
- 2) Tap on "**Build number**" 7 times to enable it. During the process, you'll see a prompt with a countdown reading "**You are now X steps way from being a developer.**"
- 3) Once the prompt "**You are now a developer!**" showing up, you have succeeded in entering developer mode. You can find **Developer Option** { } is now enabled in **Settings**  page.

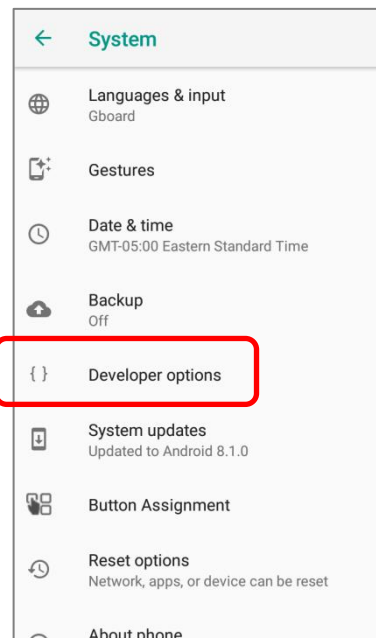
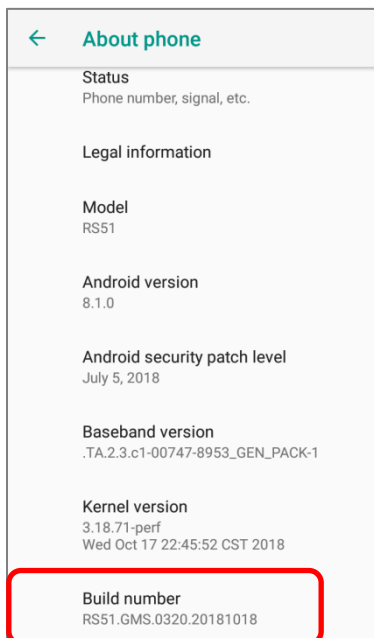

## CHECK MEMORY USAGE

Tap [App Drawer \(All Apps\)](#) | **Settings**  | **Developer Option** { } | **Memory**  to enter memory manager screen.

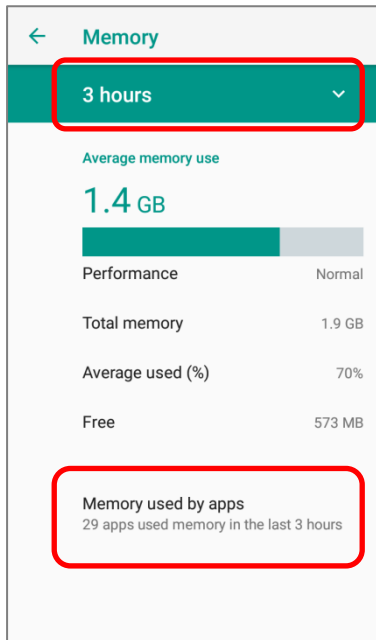

On the main screen, it tells you not only the used and free memory space of the RAM, but how your pattern of usage has impacted the device's overall performance. To figure out how the system and apps have been taking up the memory over a longer period, tap the dropdown list to choose a different time span.

To look at how individual apps are consuming the memory space, tap "**Memory used by apps**" to get a breakdown of memory usage by apps.

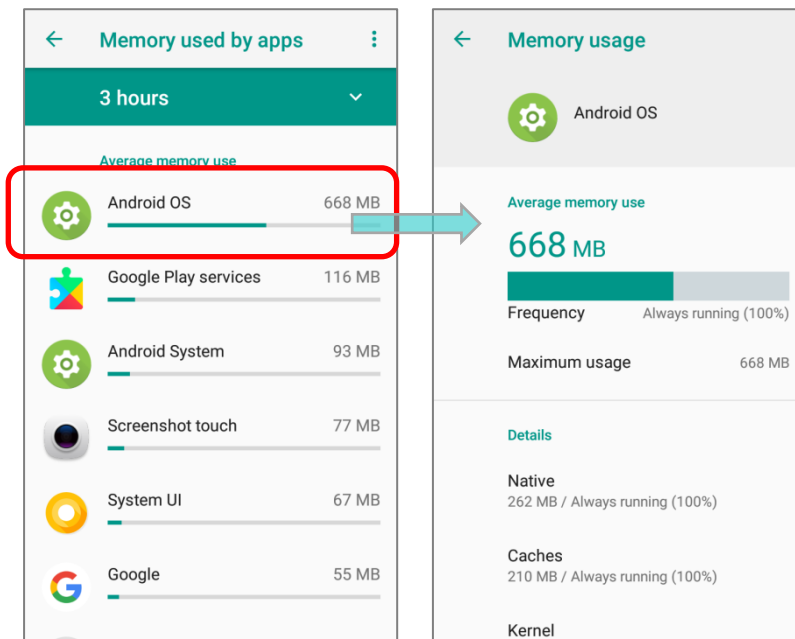

Tap an application name to check its memory usage. This allows you to make sense of how much memory a newly-installed application can potentially consume your RAM.



## 2.2.2. MANAGE STORAGE SPACE

To your Android device, the SD card can serve as an extension of your device's internal storage (which comes as 16 GB of flash memory to store the OS, applications and files) other than a portable storage place.

Go to [App Drawer \(All Apps\)](#) | **Settings**  | **Storage**  to check usage of the internal and external storage spaces.

By default, all the videos, photos and downloaded files are directly saved to the device's internal storage. If you have previously inserted and mounted an SD card as portable storage, you could transfer/save photos & other media in this SD card; if the SD card is set as internal storage, photos, files, and some apps could be moved to the SD card.

### SD card as portable storage in Storage Settings page

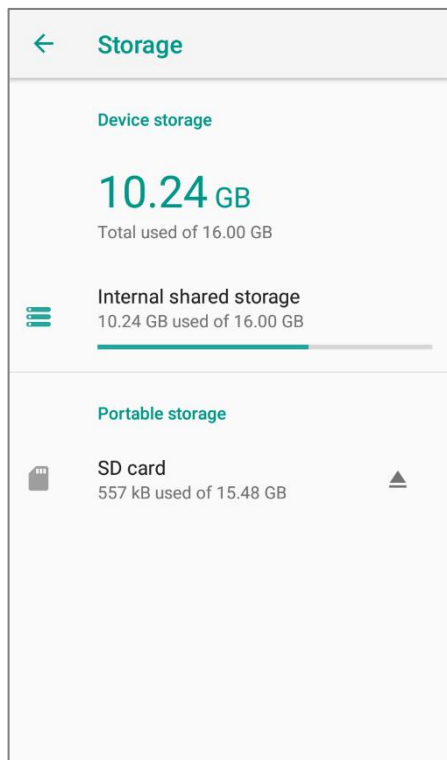

The SD card is used for moving photos and other media between devices.

### SD card as internal storage in Storage Settings page

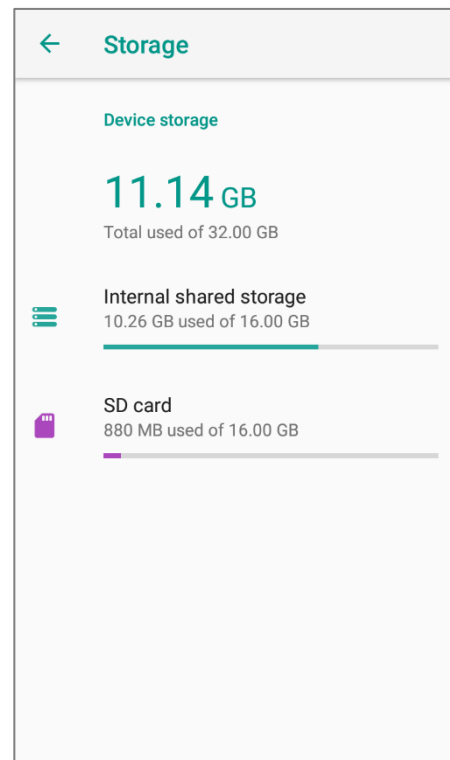

The SD card is used for storing anything on this device only, including apps and photos. Requires formatting that prevents it from working with other devices.

## SET UP SD CARD AS PORTABLE STORAGE

Using SD card as a portable device allows you to treat it as a USB disk, by swapping it between your Android device and the computer to easily transfer files. This is quite handy when there is a need to offload files that are taking up too much storage space.

When this device is connected with PC, the disk content is readable from PC client:

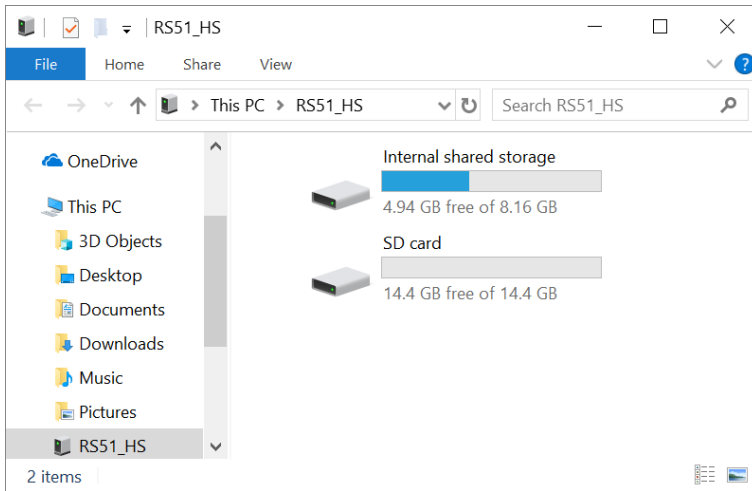

On **Storage** screen, this disk can be managed separately.

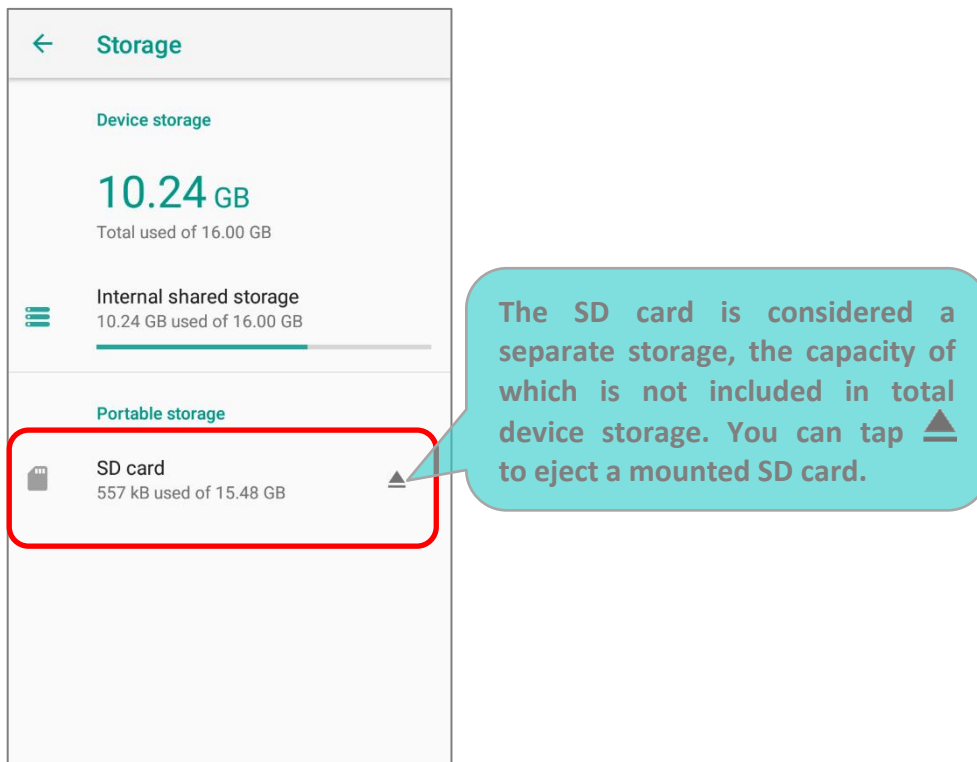

To start:

- 1) Insert the SD card. A notification icon indicating that an SD card is detected will be shown in the status bar; swipe down from the status bar and tap on **"SET UP"**.
- 2) Tap **"Use as portable storage"** and then **"NEXT"**.
- 3) When the setting is completed, tap **"DONE"**.

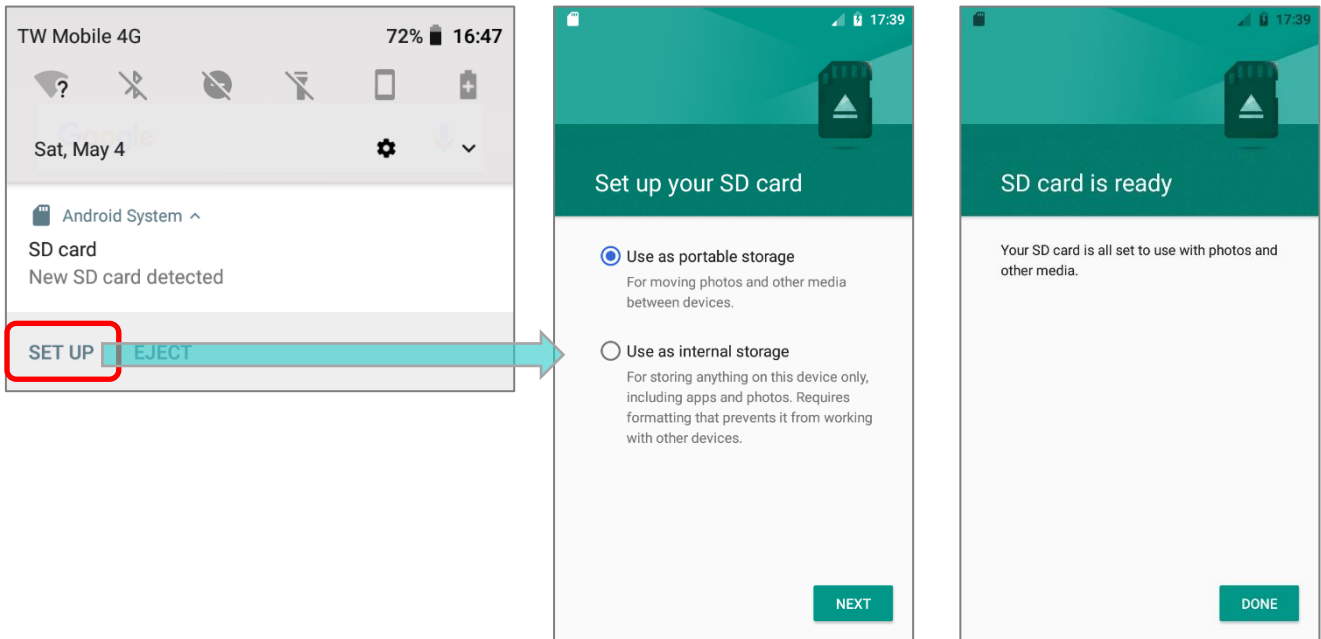

- 4) Swipe down from the status bar to reveal Notifications Drawer, and you will find a notification indicating that the SD card is for transferring photos and media; tap **"EXPLORE"** to check its content.  
**OR** tap the SD card in Storage Settings page to check it.

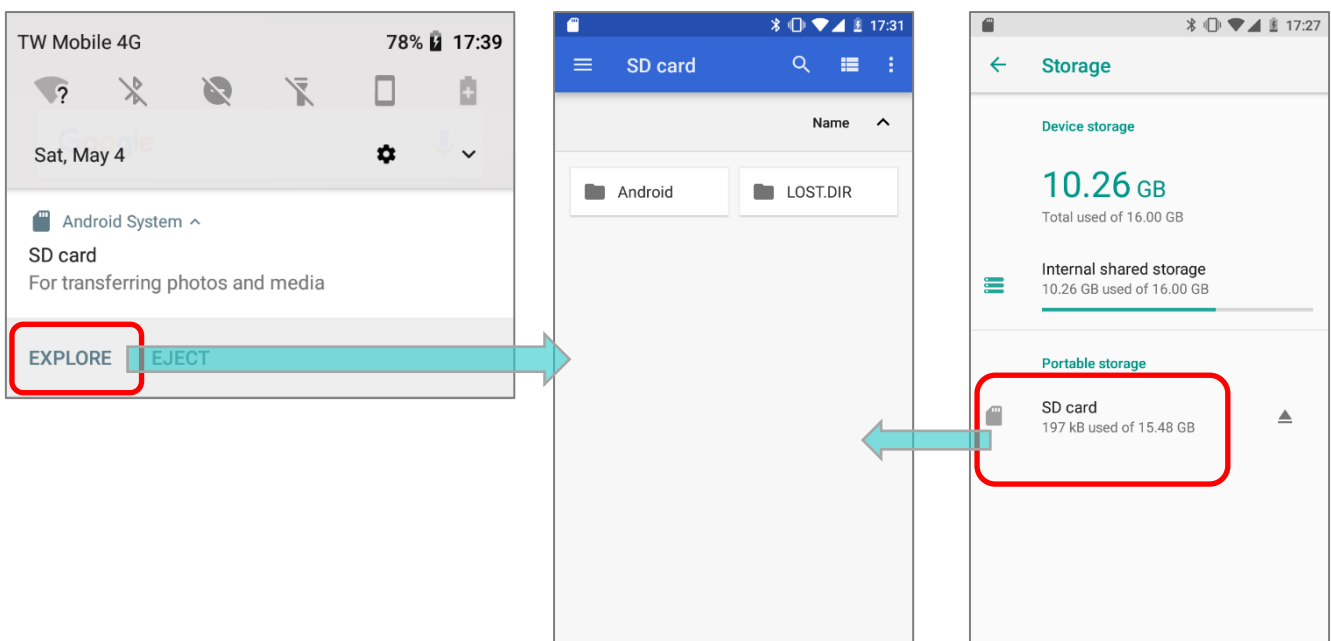

## TRANSFER PHOTOS & MEDIA BETWEEN THE DEVICE & PC

To transfer photos and media between this device and PC when the mounted SD card is set as portable storage, please:

- 1) Connect your mobile computer with PC with supplied USB cable.
- 2) Swipe down from the status bar to reveal Notifications Drawer, and tap "**USB charging this device**" to enter USB options menu.
- 3) Choose "**Transfer files**", and now you will find the disk content is readable from PC client. Please make sure the USB cable is properly connected while transferring files over USB connection.

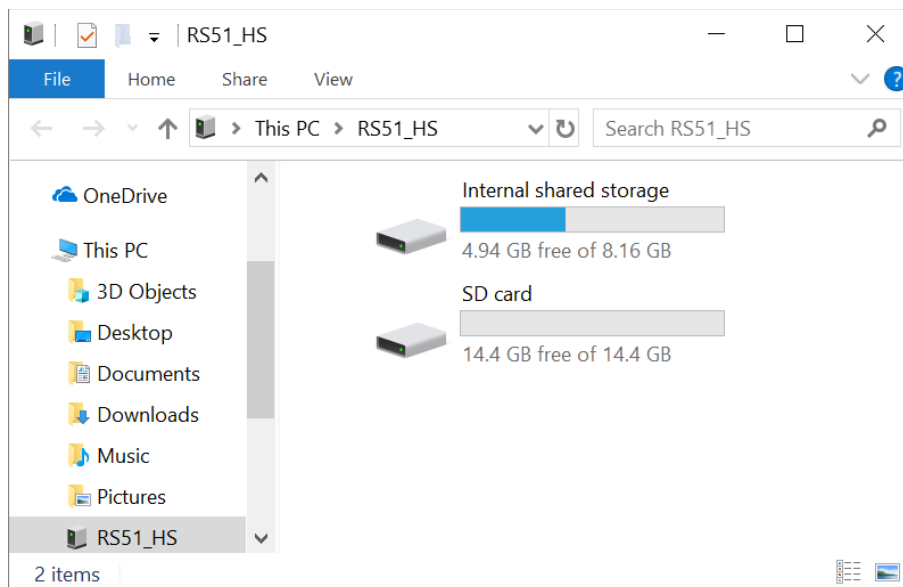
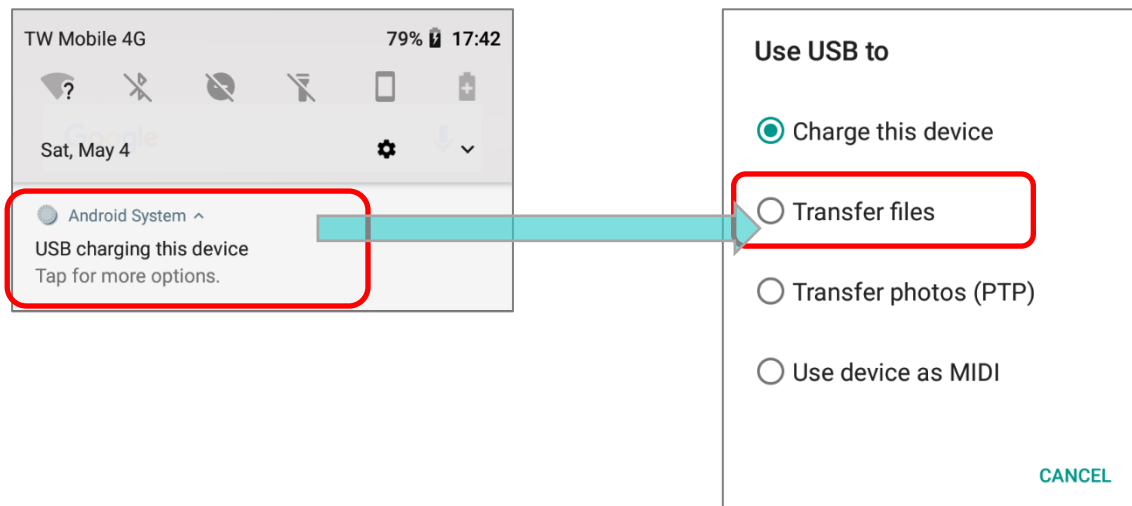

## CONVERT THE SD CARD TO INTERNAL STORAGE

- 1) You can always convert the SD Card from portable storage to internal storage. On Storage screen, tap the SD card. Before you start, make a backup of the files on this disk if you would like to keep them.
- 2) On SD card content screen, tap **More**  and then tap **"Storage settings"**.
- 3) By selecting **"Format as internal"**, the device will eventually format this SD card into a specific file format only readable by this device.

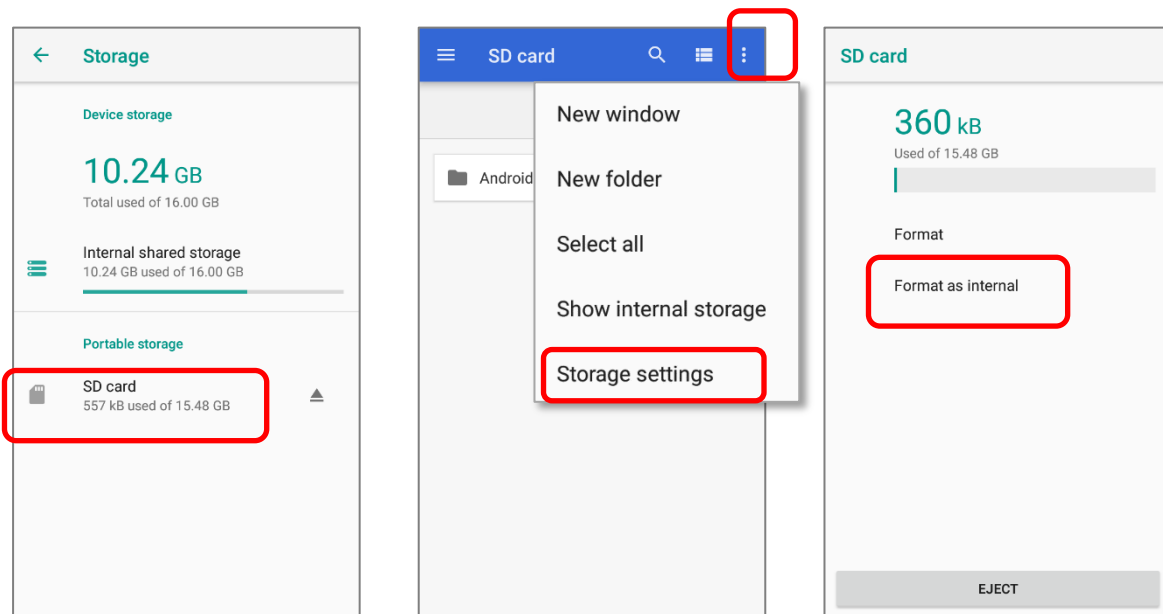

- 4) On Format as internal storage screen, tap **"ERASE & FORMAT"** to format the card.
- 5) You will then be asked whether to move multimedia files to this new SD card right away or later; make your choice and then tap **"Next"**.
- 6) When the formatting is completed, tap **"DONE"**.

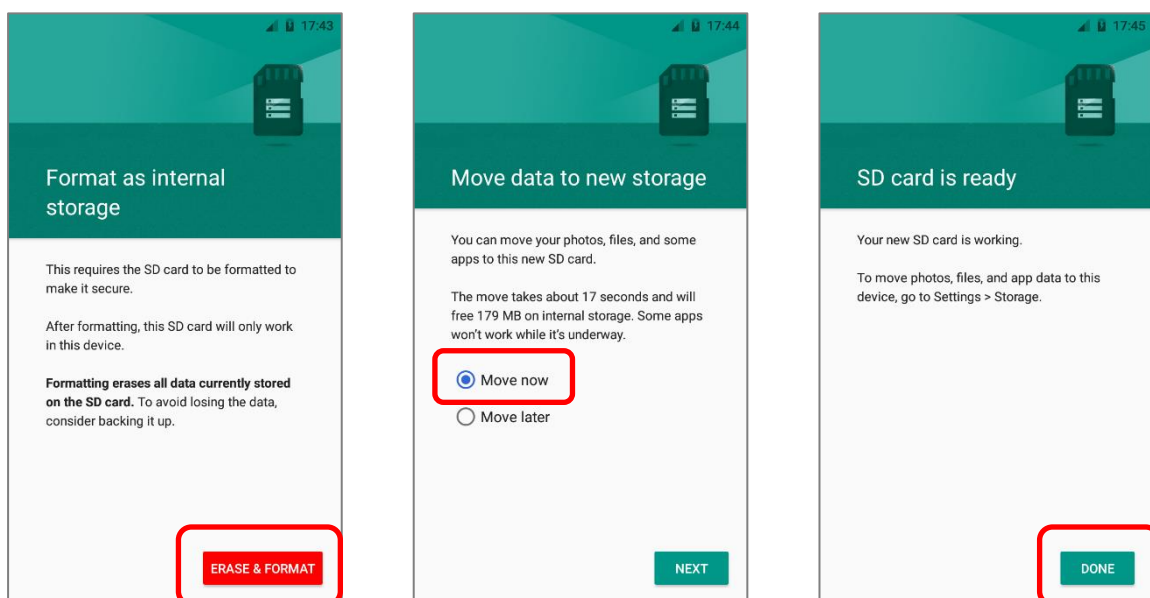

## SET UP SD CARD AS INTERNAL STORAGE

Using SD card as internal storage allows you to extend your existing device storage and to store huge applications. This SD card will be reformatted and encrypted with a file format that is not readable by another device. Therefore, it is essential that you back up important files on this SD card in advance. Please note that if you eject this SD card, the applications and media files stored on it will not be available until you reinsert the card.

When this device is connected with PC, the disk content is not readable from PC client:

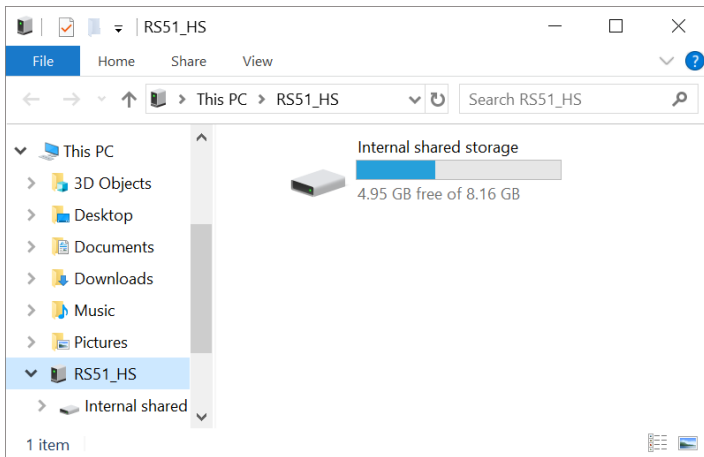

On the **Storage & USB** screen, the capacity of this SD card is merged into the total device storage. Please note that. In this setting, you will have no control of which files to be stored on SD card.

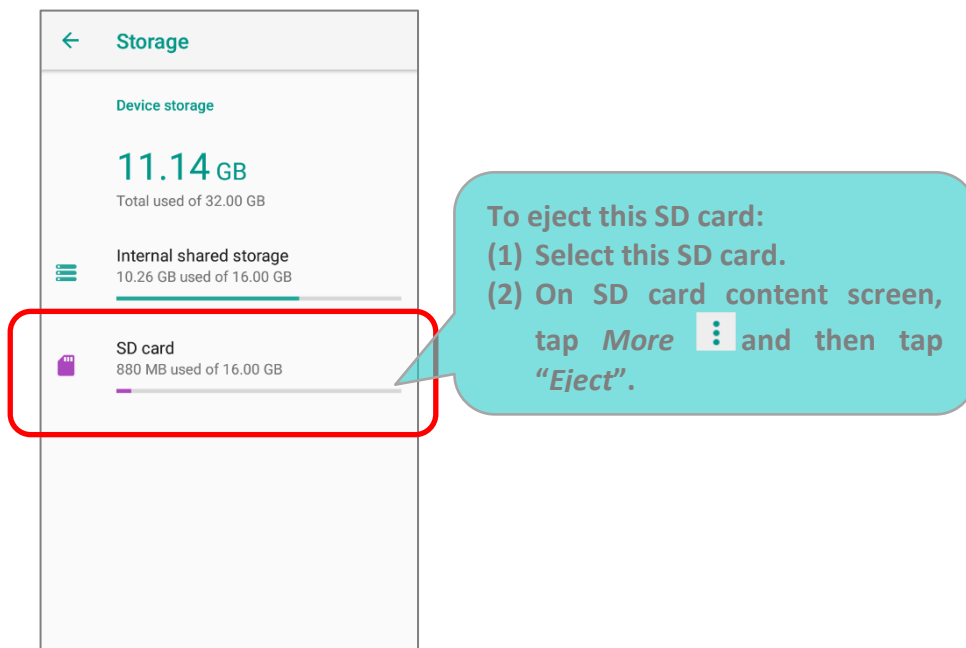

**Warning:** Do not physically remove the SD card from the device without ejecting this card in advance.

To start:

- 1) Insert the SD card. A notification will pop up indicating that an SD card is detected tap **"SET UP"**.
- 2) Tap **"Use as internal storage"** and then **"NEXT"**.
- 3) Tap **"ERASE & FORMAT"** to format this card.

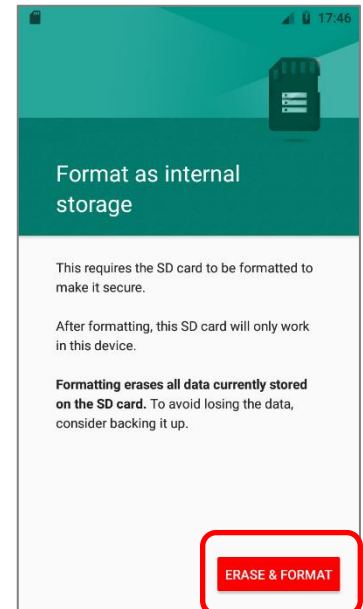
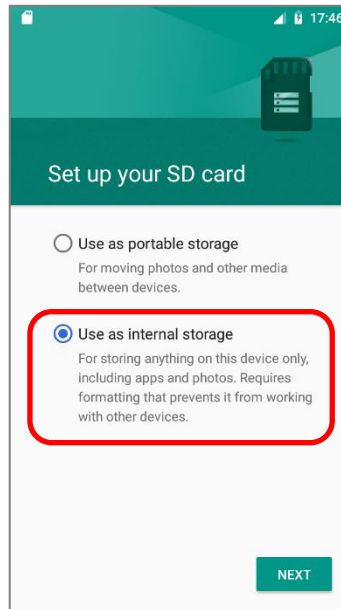
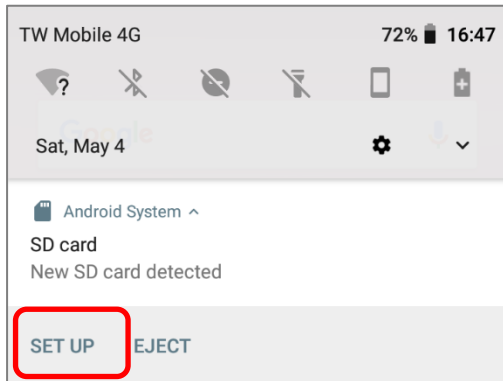

- 4) You will then be asked whether to move media files to this new SD card; make your choice and then tap **"Next"**.
- 5) When the setting is completed, tap **"DONE"**.

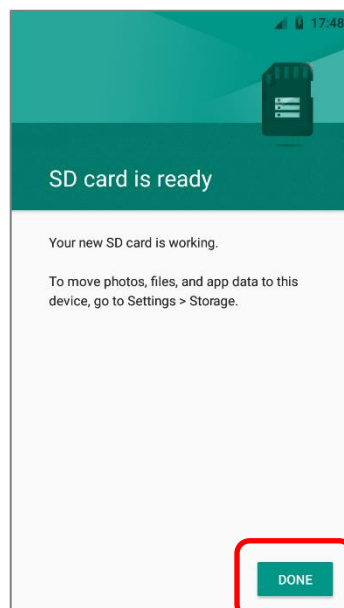
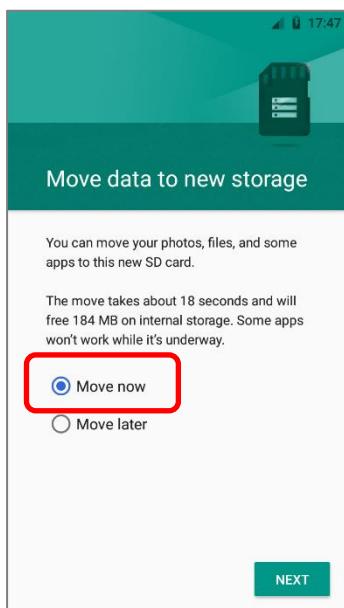

**Note:**

It is recommended that you select **"Move now"** at Step 4 to have the device immediately start making use of SD card space. If you select **"Move later"**, the device will continue to consider device's original storage the primary location to save files.

### CONVERT THE SD CARD TO PORTABLE STORAGE

- 1) You can always convert the SD Card from internal storage to portable storage. On **Storage & USB**, tap the SD card. Before you start, make a backup of the files on this disk if you would like to keep them.
- 2) On SD card content screen, tap **More** and then tap **"Format as portable"**.
- 3) Tap **"Format"** to have this SD card re-formatted into a file type inaccessible by other devices.

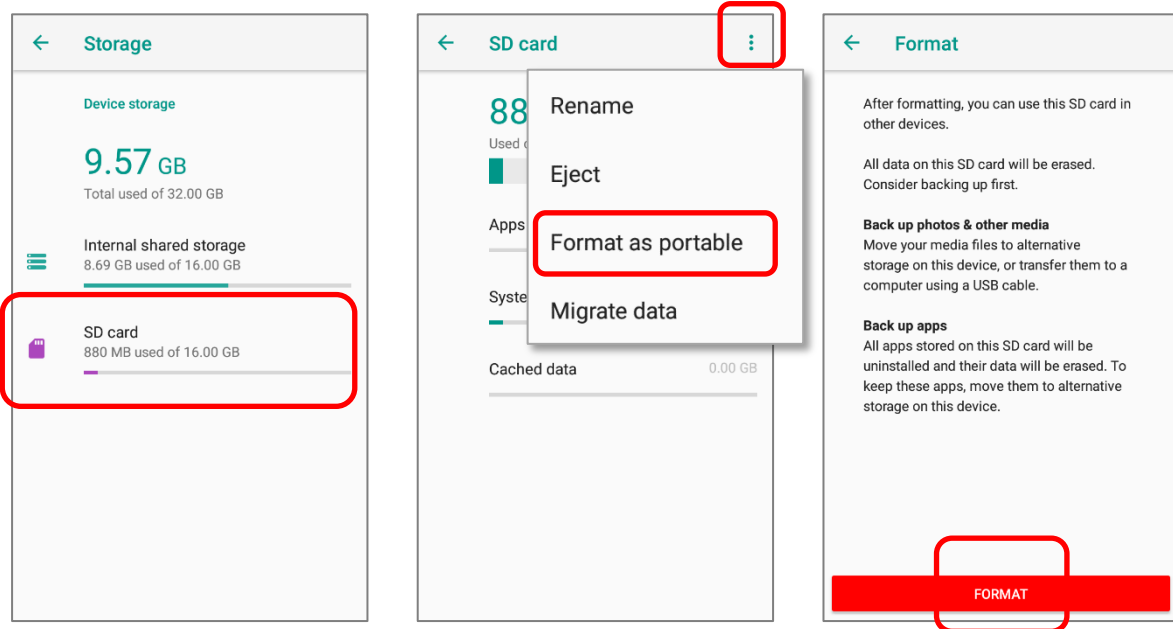

- 4) When the formatting is completed, tap **"DONE"**.

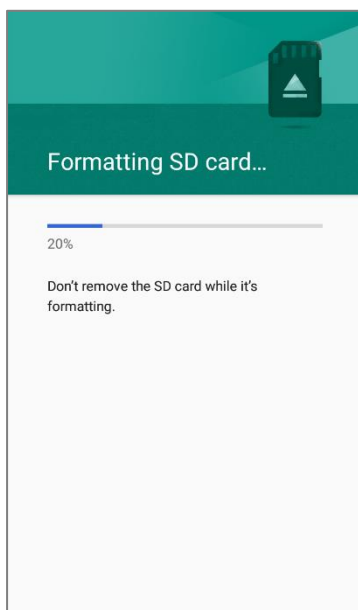

#### Note:

Please do back up important files on this SD card before proceeding formatting.



## 2.3. TOUCH SCREEN

The mobile computer comes with a 4.7" transmissive LCD with 1280 by 720 pixels resolution (HD). The LED backlight of the screen, which helps ease reading under dim environments, can be controlled manually and automatically.

**Warning: DO NOT use any pointed or sharp objects to move against the surface of the screen.**

### 2.3.1. SCREEN BRIGHTNESS

Go to [App Drawer \(All Apps\)](#) | **Settings**  | **Display**  | **Brightness level**.

Adjust screen brightness by dragging the slider to the right (to increase brightness) or left (to reduce brightness). Switch on the Adaptive brightness to enable automatic backlight adjustment with the mobile computer's built-in sensor.

You can also use the shortcut button on **Quick Settings menu** to adjust the brightness level.

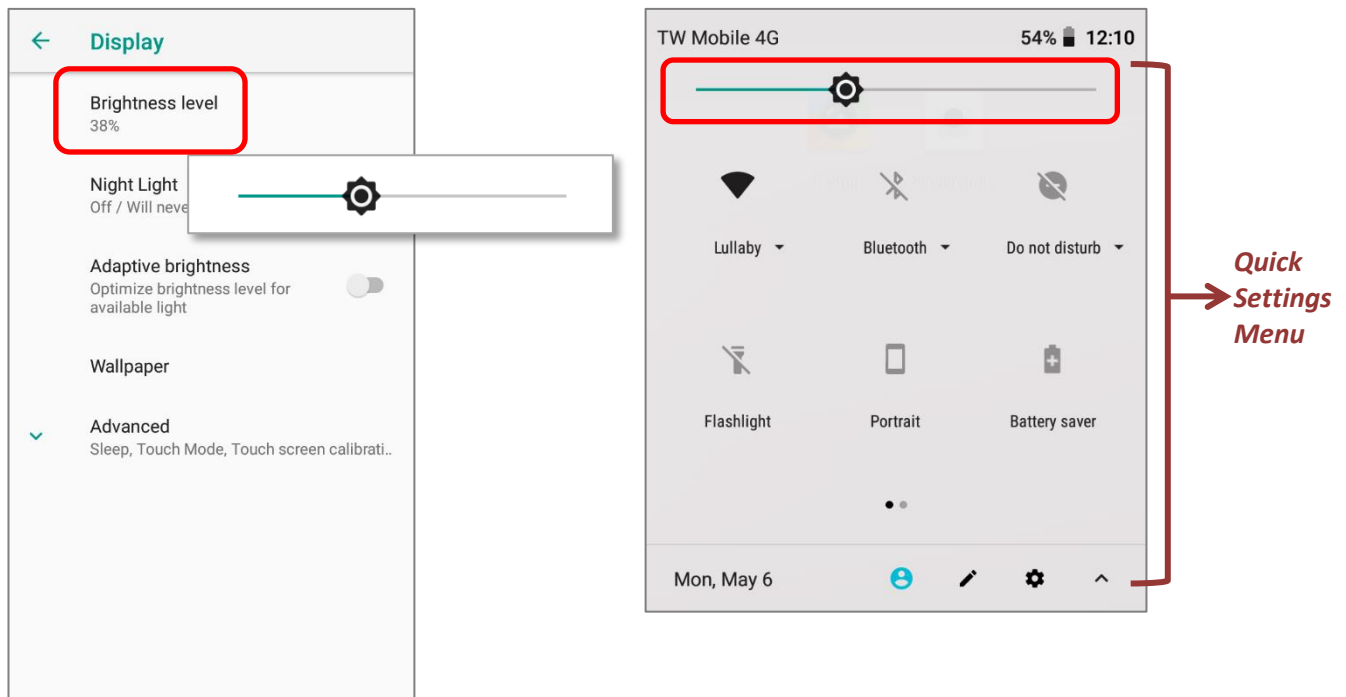



#### Note:

To save battery power, dim the screen brightness while working in a well-lit area, or set a shorter sleeping plan for the screen backlight to go off.

## 2.3.2. SCREEN ROTATION

By default, the device automatically rotates the screen to when you turn the device sideways. To switch this function on or off:

- 1) Go to [App Drawer \(All Apps\)](#) | **Settings**  | **Display** 
- 2) Tap **Advanced** for more display settings, and switch on or off **Auto-rotate screen**.

**OR**

- 3) Use two fingers to swipe down from the top of the screen to open **Quick Settings menu** and tap the **Auto rotate** icon to enable screen rotation. This quick setting method allows you to temporarily enter landscape mode to enhance your typing experience by using a wide keyboard.

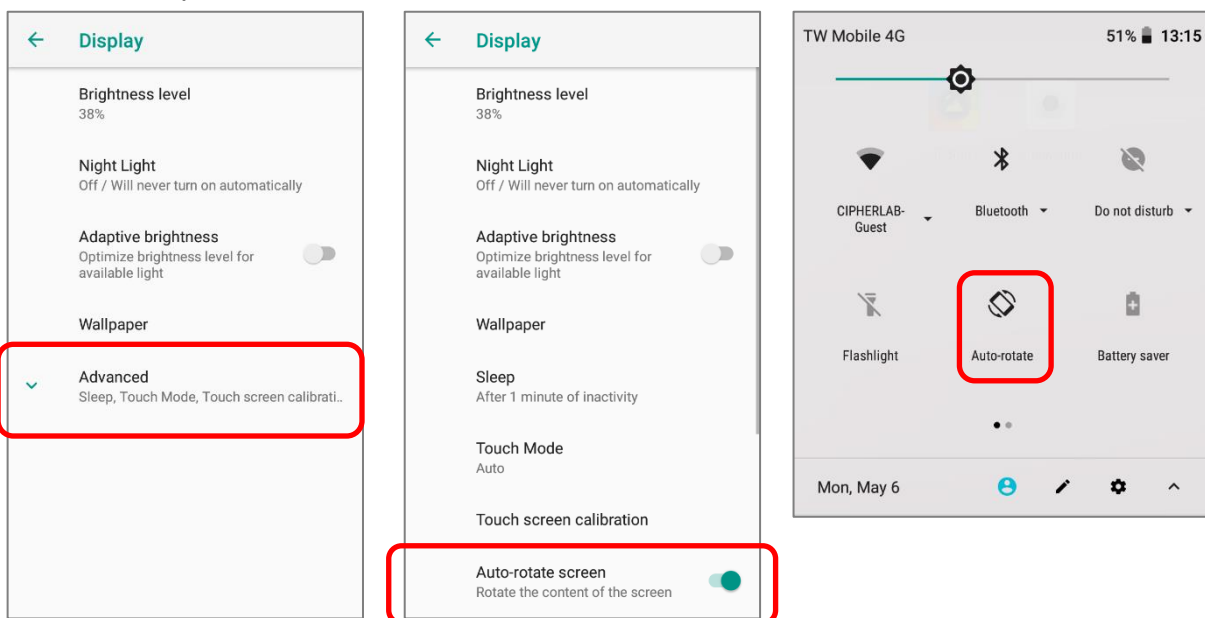

To enable Home screen rotation, please make sure Auto Rotation is enable. Press any empty spot on Home screen, tap "**Home Settings**" and enable "**Allow Home screen rotation**":

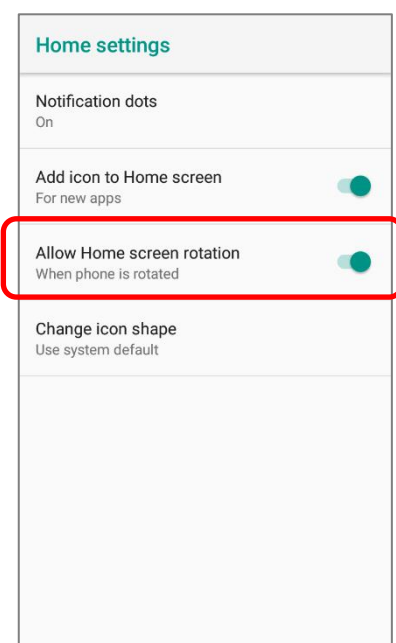

## REMOVE AUTO-RITATE FROM QUICK SETTINGS MENU & DISPLAY SETTINGS



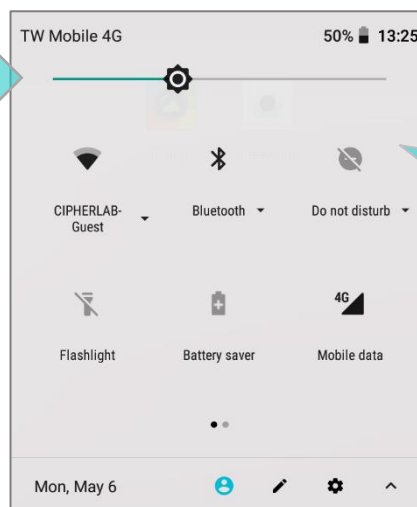
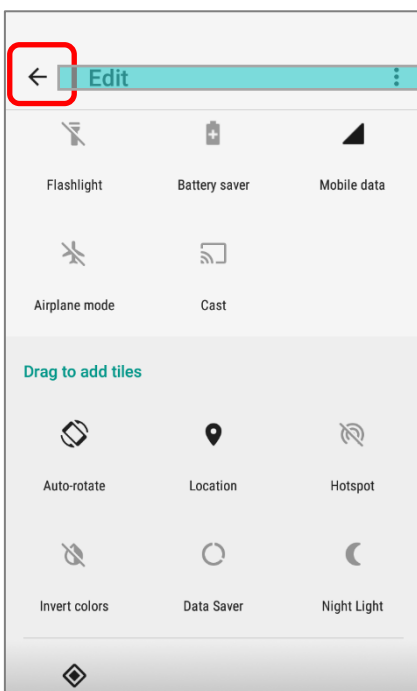
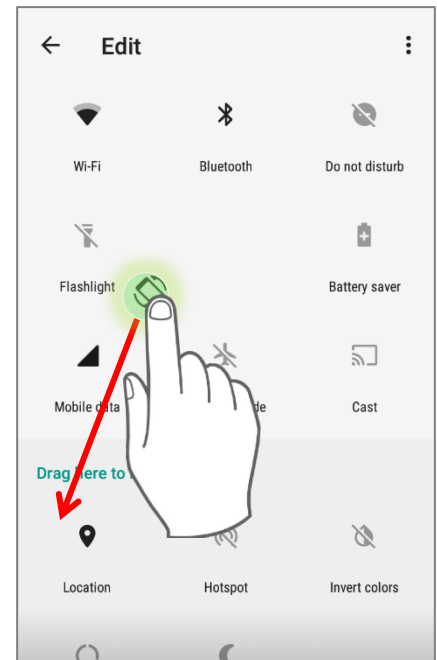
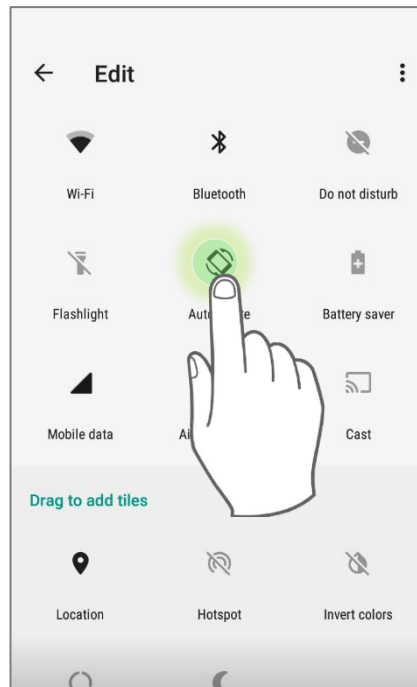
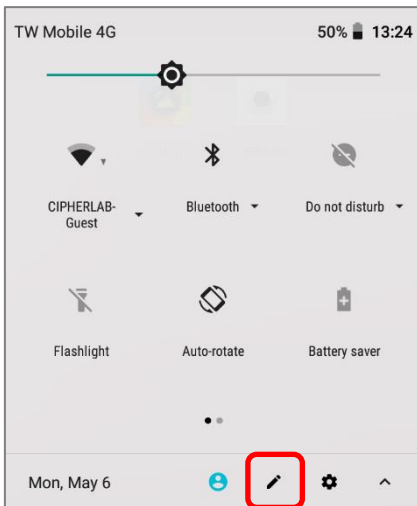

You can remove the **Auto-rotate** switch icon on Quick **Settings menu** to minimize the possibility of accidentally turning on the auto-rotation function:

- 1) Use two fingers to swipe down from the top of the screen to open **Quick Settings menu**.
- 2) Click  button to get into **Edit** page; tap on and hold the **Auto-rotate** switch icon, and drag it to the "**Drag here to remove**" area and then release it.
- 3) Return to the **Quick Settings menu**, the Auto rotate switch icon is now hidden.

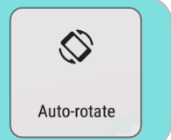

The Auto-rotate status icon is absent.



Go to [App Drawer \(All Apps\)](#) | **Settings**  | **Accessibility**  and switch off Auto-rotate screen. By doing so, the auto-rotation option will be hidden in **Settings**  | **Display** .

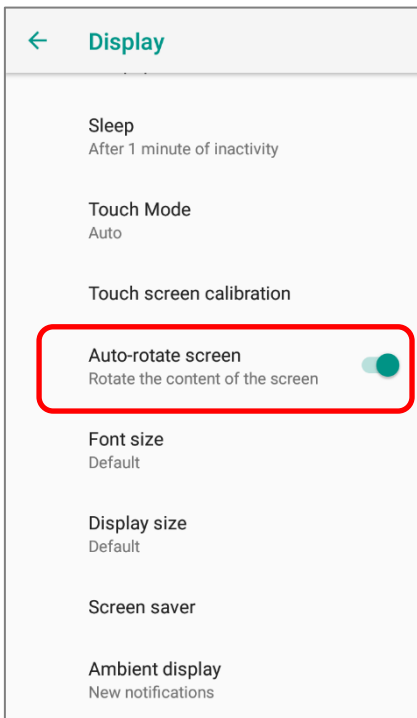

**Step 1:**  
The original “Display” page where the function “Auto-rotate screen” is listed on.

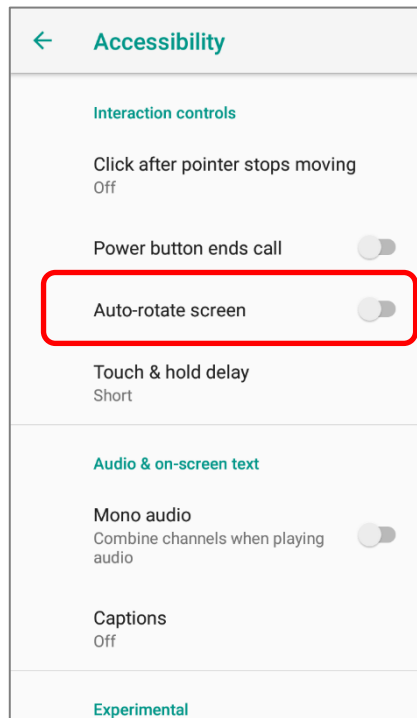

**Step 2:**  
Switch off “Auto-rotate screen” on “Accessibility” page.

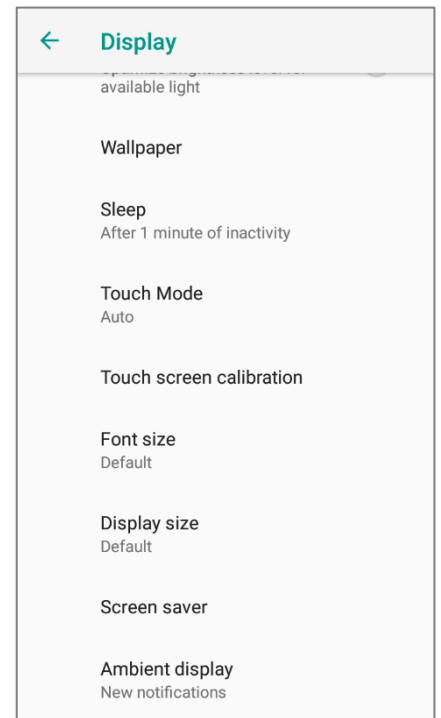

**Step 3:**  
Now the function “Auto-rotate screen” is hidden on “Display” page.

**Note:**

Auto-rotation is not supported for certain applications. Without enabling “[Allow Home Screen Rotation](#)”, auto-rotation is inapplicable in Home Screen and App Drawer screen.

### 2.3.3. SCREEN TIMEOUT SETTINGS

Go to [App Drawer \(All Apps\)](#) | **Settings**  | **Display**  | **Advanced** | **Sleep**.

Select the time lapse for screen timeout.

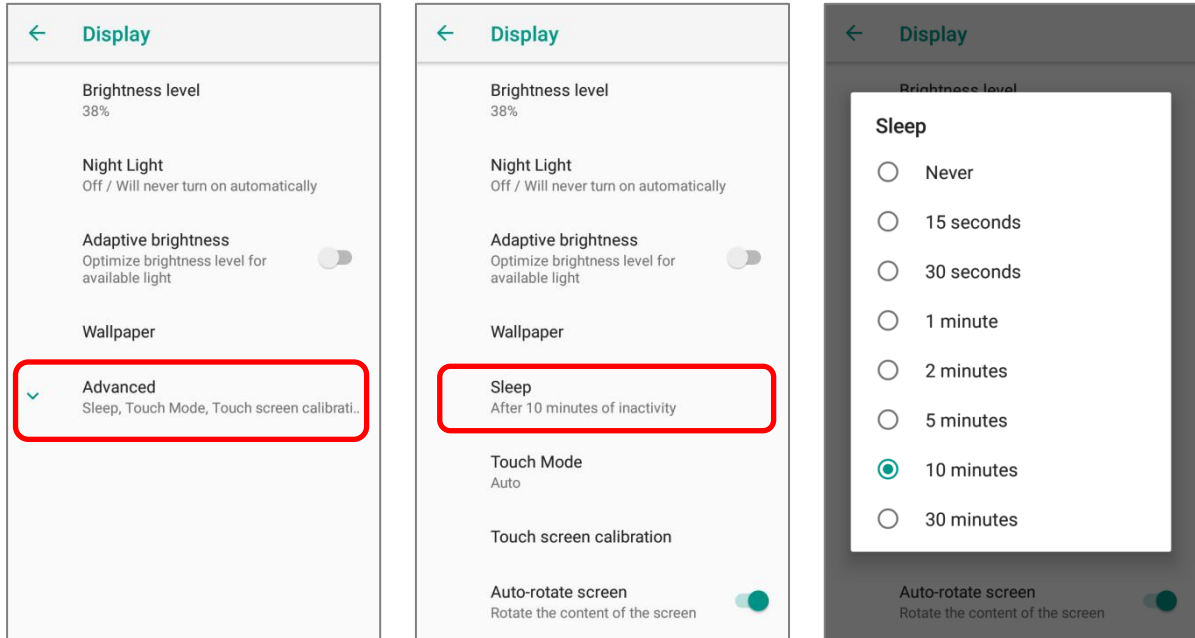



### 2.3.4. TEXT SIZE & DISPLAY SIZE

To change text size, please go to [App Drawer \(All Apps\)](#) | **Settings**  | **Display**  | **Advanced** | **Font size**.

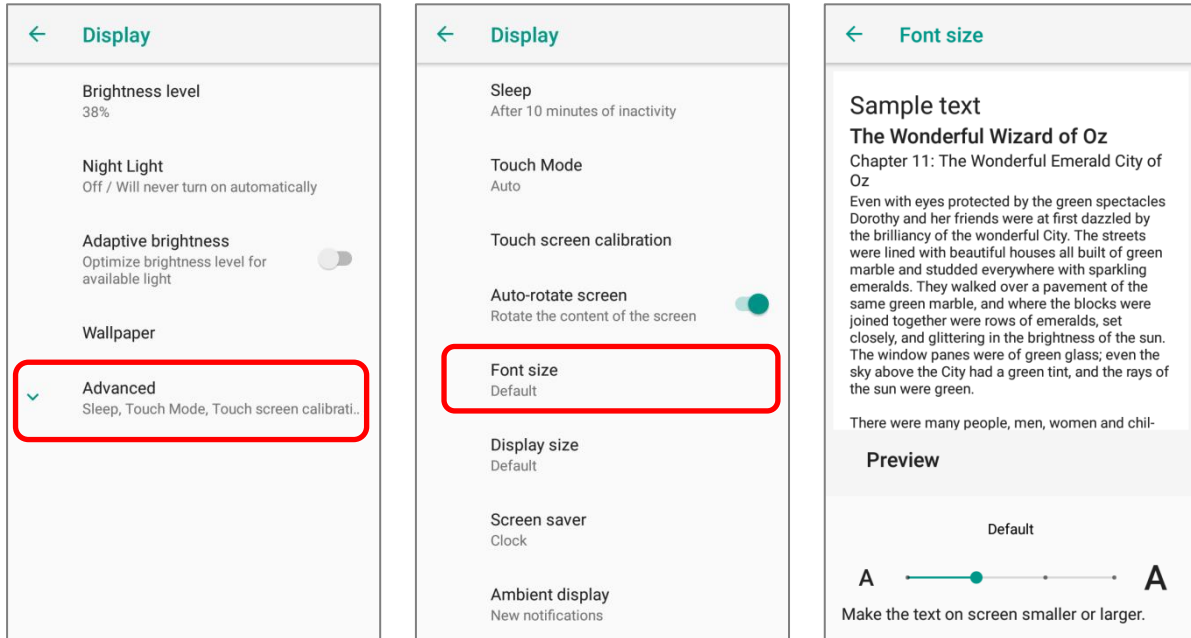
Tap the small A icon  or the large A icon  to select the font size between Small, Default, Large and Largest.



Go to [App Drawer \(All Apps\)](#) | **Settings**  | **Display**  | **Advanced** | **Display size**, and tap the plus icon  or the minus icon  to select the display size as Small or Default.

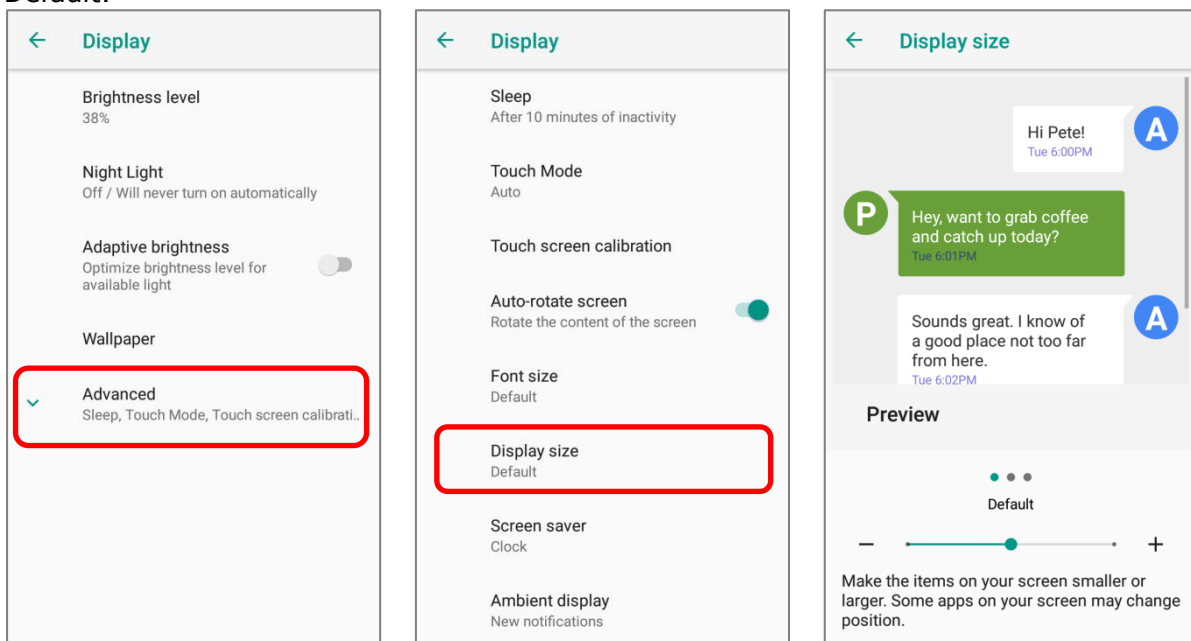

## 2.4. NOTIFICATIONS

### 2.4.1. STATUS LED

Two LED indicators located above the touch screen provide information about charging status, scanner light beam, and scanner "**Good Read**" during data collection.

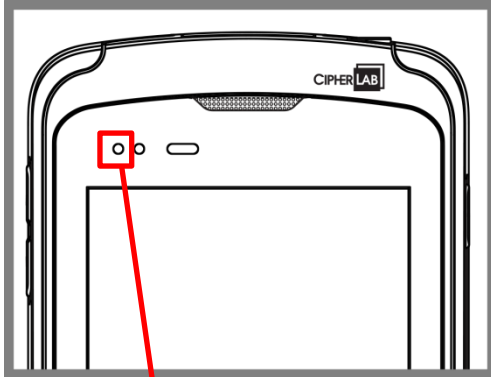

Indicator	Status	Description
Charging	Green, solid	Charging complete
	Red, solid	Charging the mobile computer
	Red, blinking	Charging error (for instance, battery not in place)
Backup battery power being used	Red, solid	Upon the removal of the main battery the red light is on for a while and then goes off to signal that the main battery is ready to be removed.

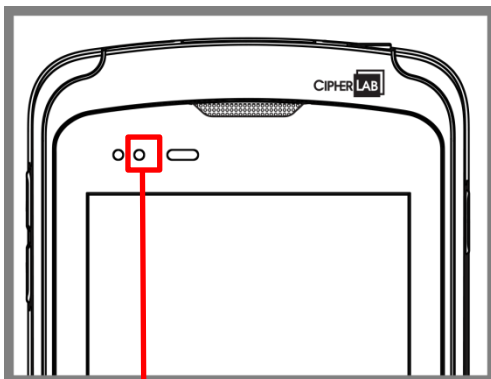

Indicator	Status	Description
Barcode or RFID tag decode	Green, flash once	Good read

**Note:** For Scanner decode and Scanner beam LED to function, LED notification must be enabled in Reader Configuration.

## 2.4.2. AUDIO

The speaker is used to play sounds for events, or play audio files. In addition, it can be programmed for status feedback. In noisy environments, you may consider connecting a headset instead. A headset jack is provided on the top of the mobile computer, which is a 3.5 mm DIA stereo earphone jack. The mobile computer also supports using Bluetooth headsets.



Supported audio file formats include: WAV, MP3, AAC, AAC+, Enhanced AAC+, AU (including ADPCM), Midi, XMF, AMR (NB and WB).

Use the volume buttons on the side of the mobile computer to adjust the system volume.

## 2.4.3. SOUNDS AND VIBRATION

The mobile computer is integrated with a vibrator, which is software programmable for tactile feedback. This can be helpful when working in noisy environments.

You may also set the mobile computer to vibrate only, in which all system sounds will be muted and replaced by the vibrator.

On any screen, press down **Volume Up** or **Volume Down** key to open quick sound menu. Tap  to switch this device to  Vibration mode. To modify specific sound settings, tap  to access more settings.

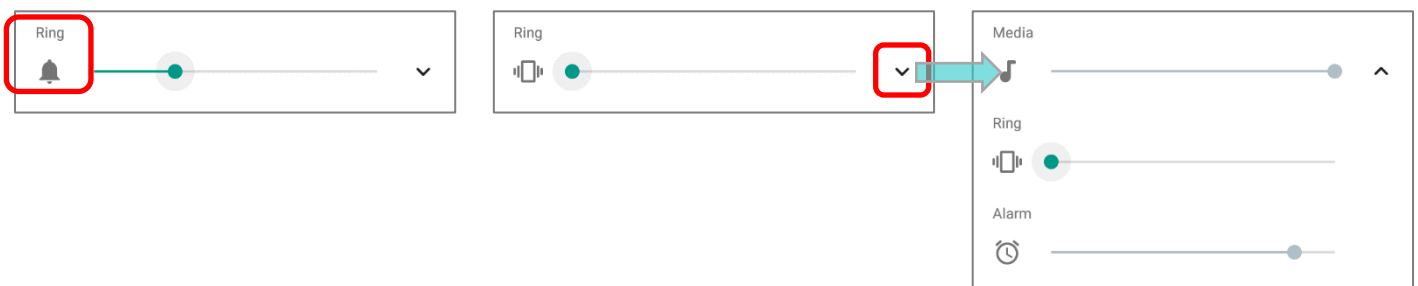

Keep pressing **Volume Down** key to turn the device into **Do not disturb** mode directly.

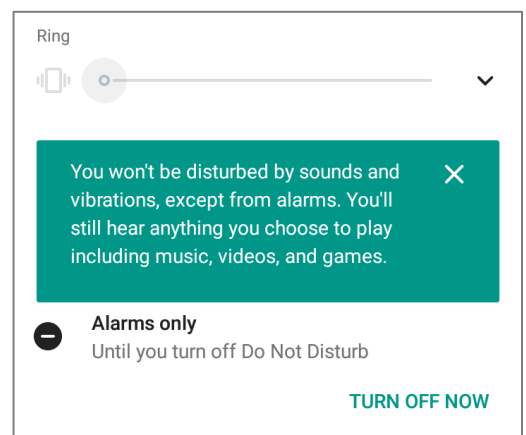



## SOUND SETTINGS

Go to [App Drawer \(All Apps\)](#) | **Settings**  | **Sound**  for more sound settings.

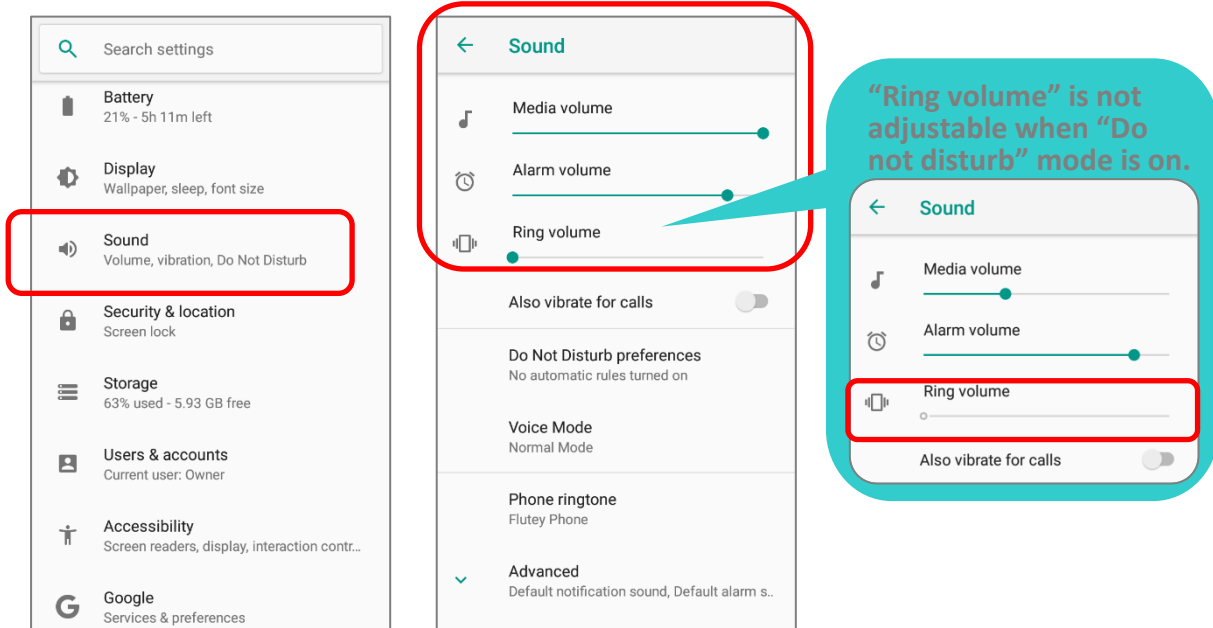

## DISABLE UNWANTED NOTIFICATIONS WITH "DO NOT DISTURB"

You can temporarily disable specific notifications (vibration or sound) using "**Do Not Disturb**" in Quick Settings menu. What's more, you can schedule the duration of the disabled status so that the notifications will switch to enabled state automatically based on your arrangement.

Use your two fingers to swipe down from the status bar to open Quick Settings, tap on "**Do not disturb**" to enable this feature and make further adjustment.

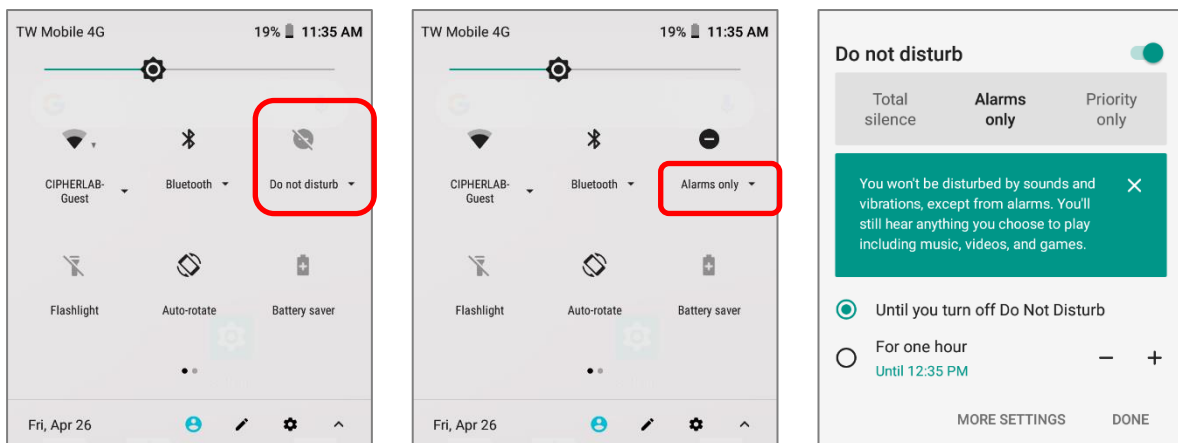

Item	Total Silence	Alarm Only	Priority Only
Alarm	OFF	ON	ON
Reminders	OFF	OFF	Adjustable (Default:ON)
Events	OFF	OFF	Adjustable (Default:ON)
Incoming Calls	OFF	OFF	Adjustable (Default:From Contacts Only)
Messages	OFF	OFF	Adjustable (Default:OFF)
Music, Video, Game or Media	OFF	ON	ON
In-Call	ON	ON	ON

Tap **"MORE SETTINGS"** to enter **"Do Not Disturb preferences"** page for detailed settings:

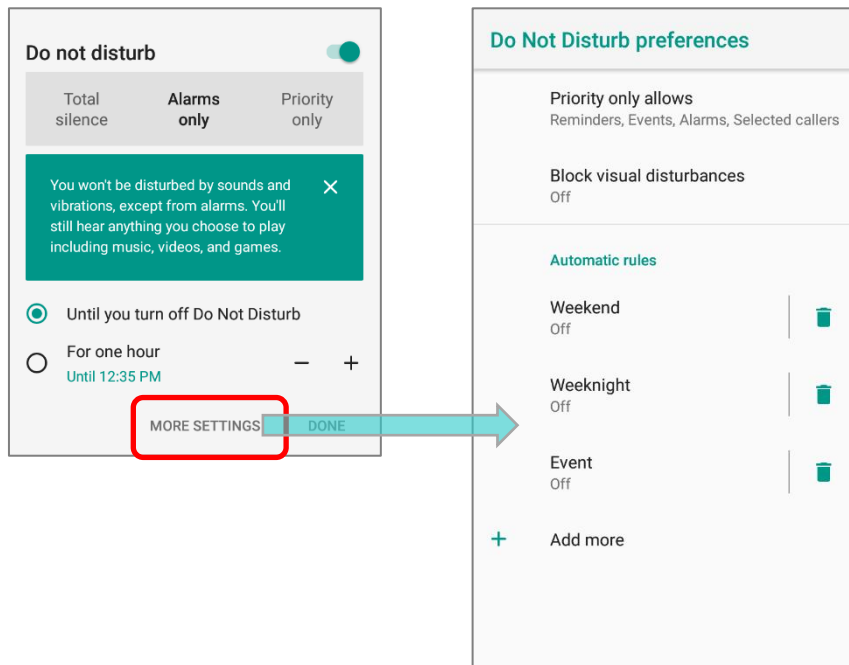

## 2.5. DATE AND TIME

By default, the mobile computer automatically synchronizes the date and time to the WWAN network (if connected).

To set the date and time manually:

1) Tap **App Drawer (All Apps)** | **Settings**  | **System**  | **Date & time** 

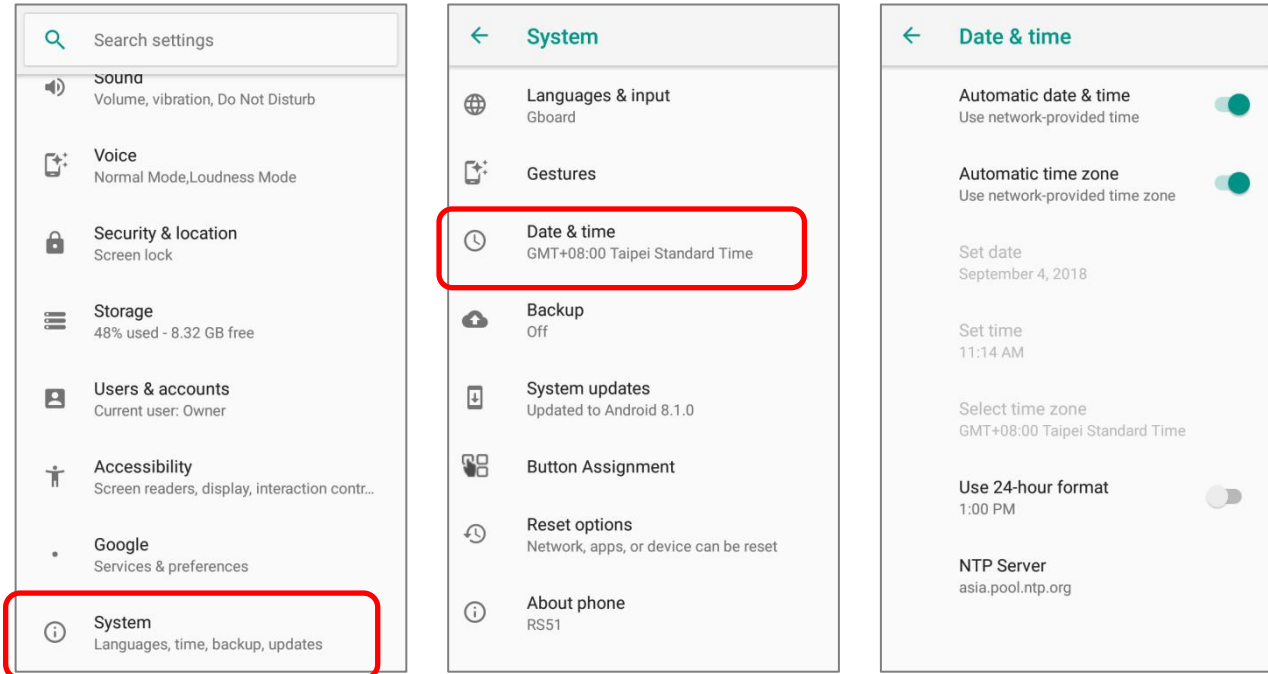

2) Tap to turn off **Automatic date & time** to disable using network-provided time.

3) Disable **Automatic time zone**.

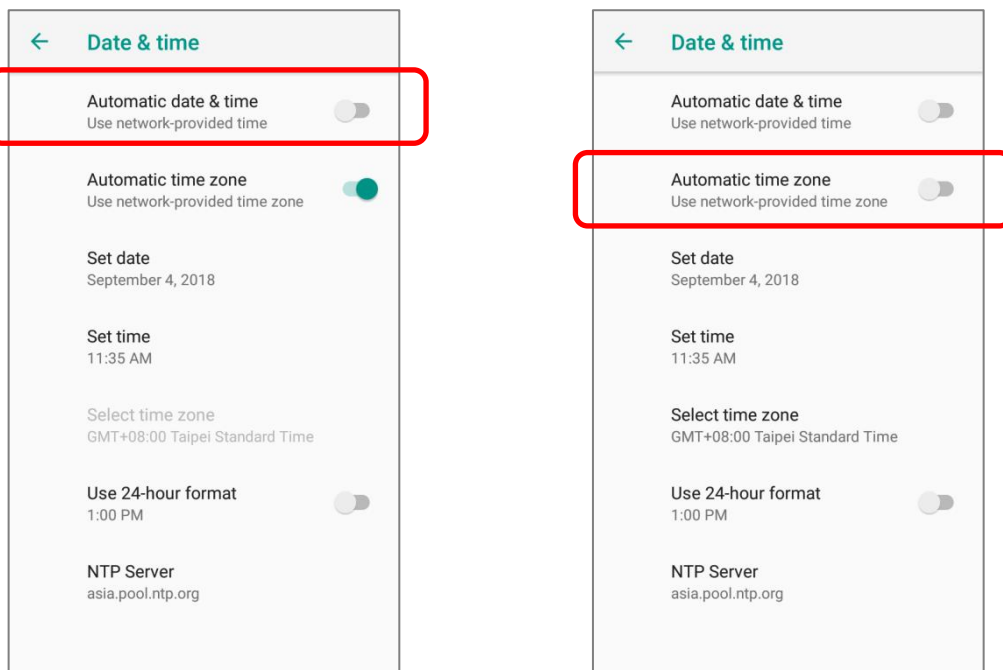

- 4) Tap **Set date** to select the correct month, date and year. Tap **OK** to save.
- 5) Tap **Set time** to set the correct time. Tap **OK** to save.

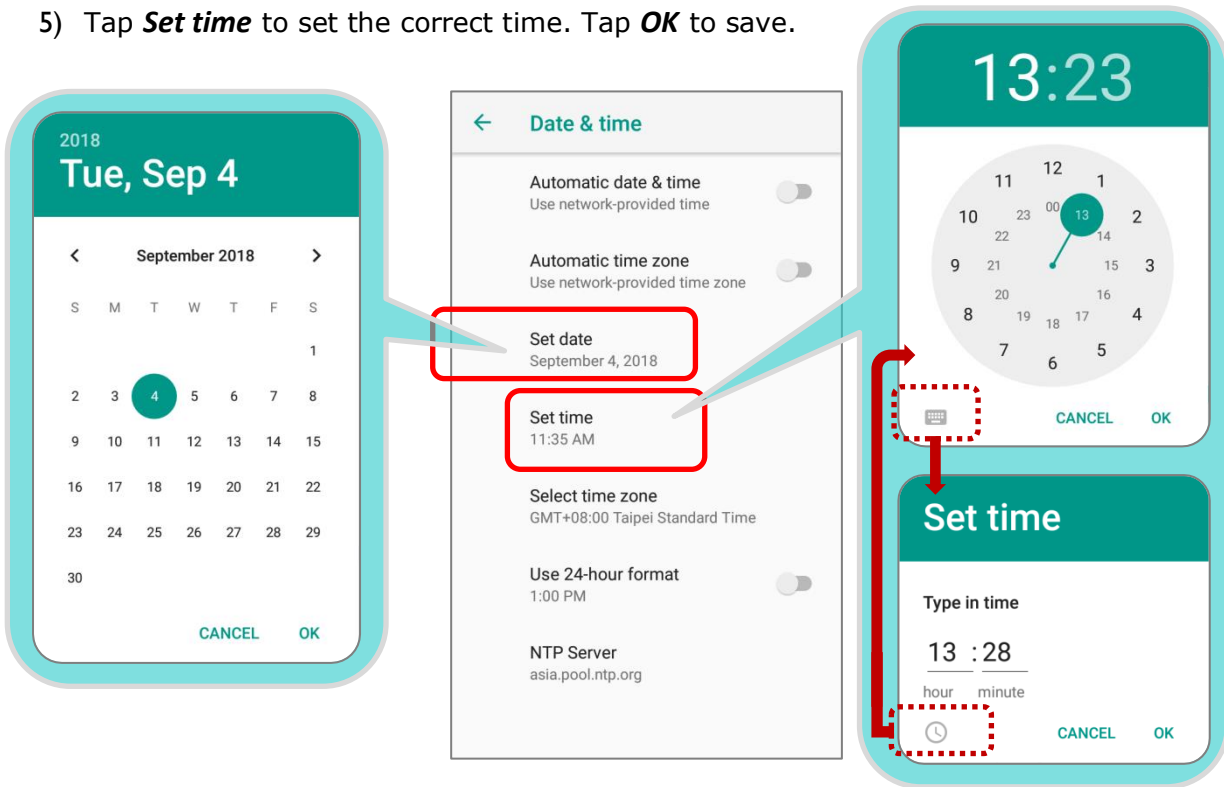

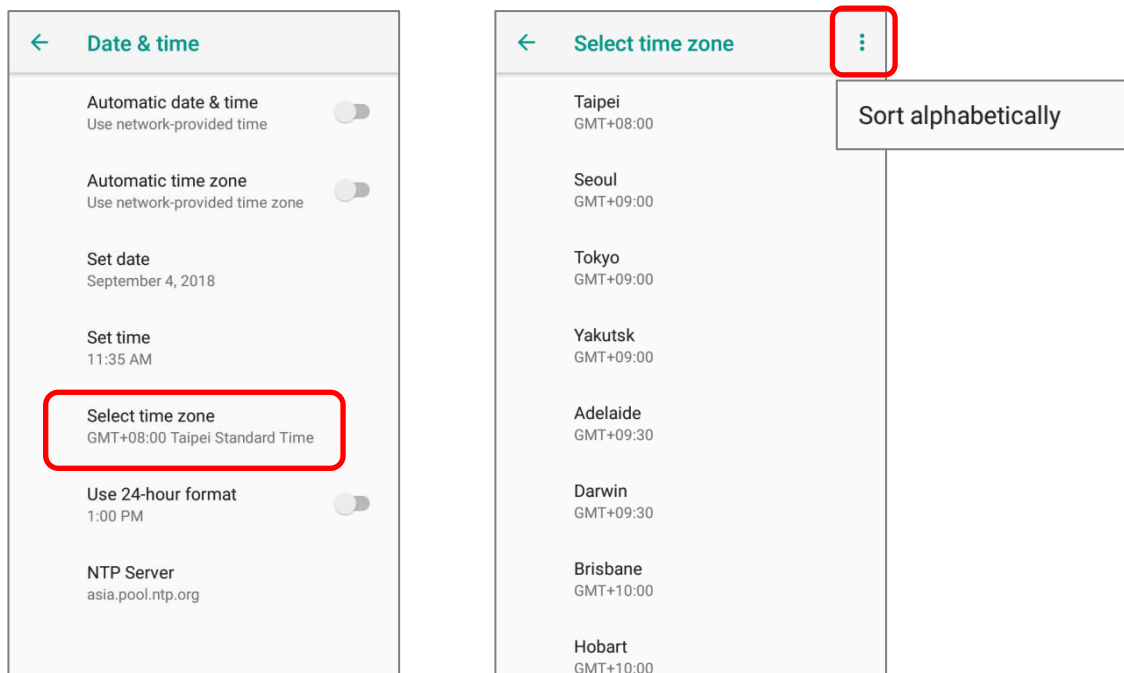

- 6) Tap **Select time zone** to select the correct time zone from the list.



- 7) Tap **Use 24-hour format** to switch on or off to change the displayed time.
- 8) Tap **NTP Server** to input NTP server address and tap **OK** to save.

## 2.6. LANGUAGE & KEYBOARD INPUT

Tap [App Drawer \(All Apps\)](#) | [Settings](#)  | [System](#)  | [Language & input](#)  to change the system language, default keyboard type, and configure keyboard input and speech settings.

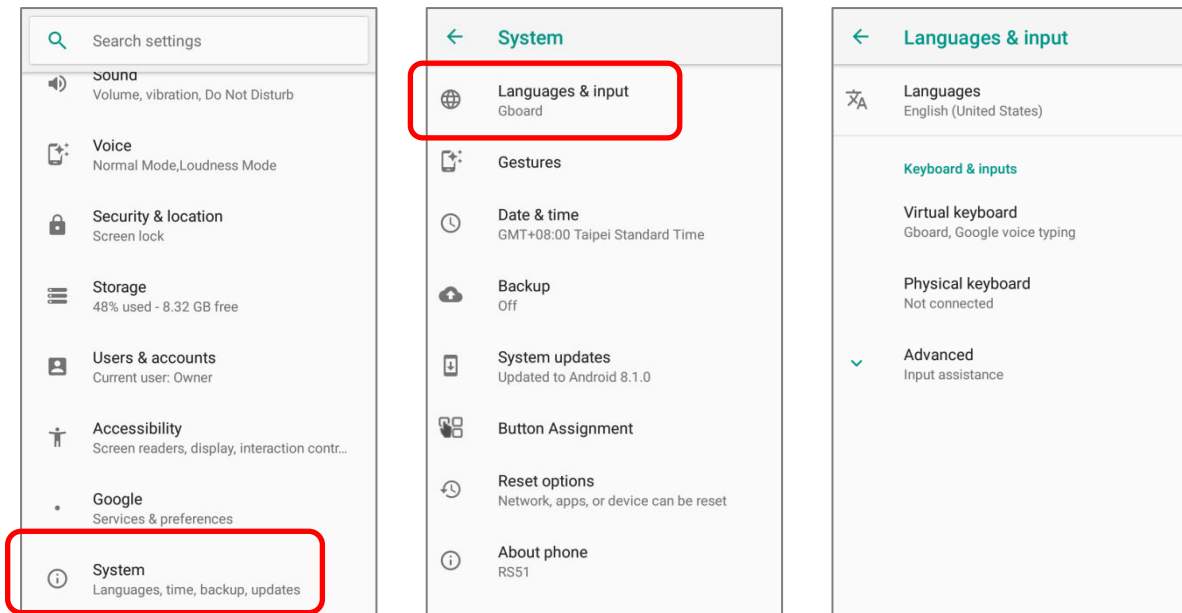

### 2.6.1. CHANGE DISPLAY LANGUAGE

To change display language:

- 1) On **Language & input** screen, tap on **Language** to get into "**Language preference**" page, and then click "**Add a language**" to select your desired system language.

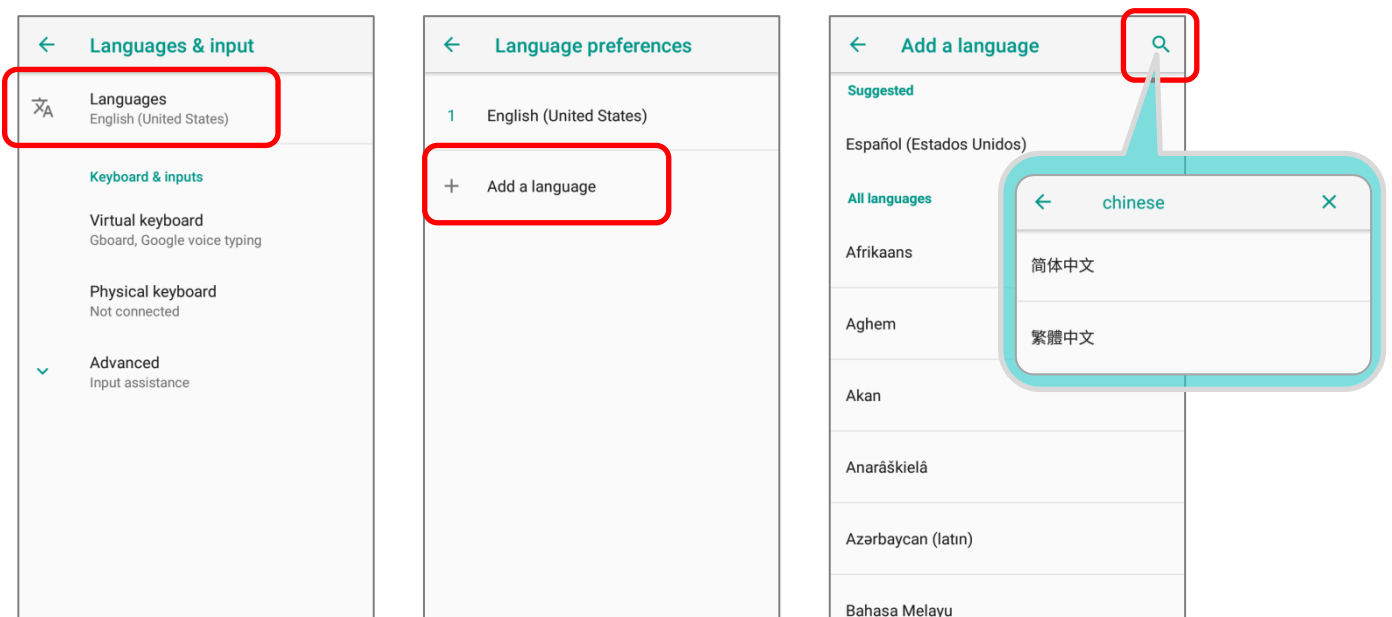

- 2) Press and hold your desired system language to change its sorting order to the 1st by dragging. Once it is released, the new language setting will immediately be applied.

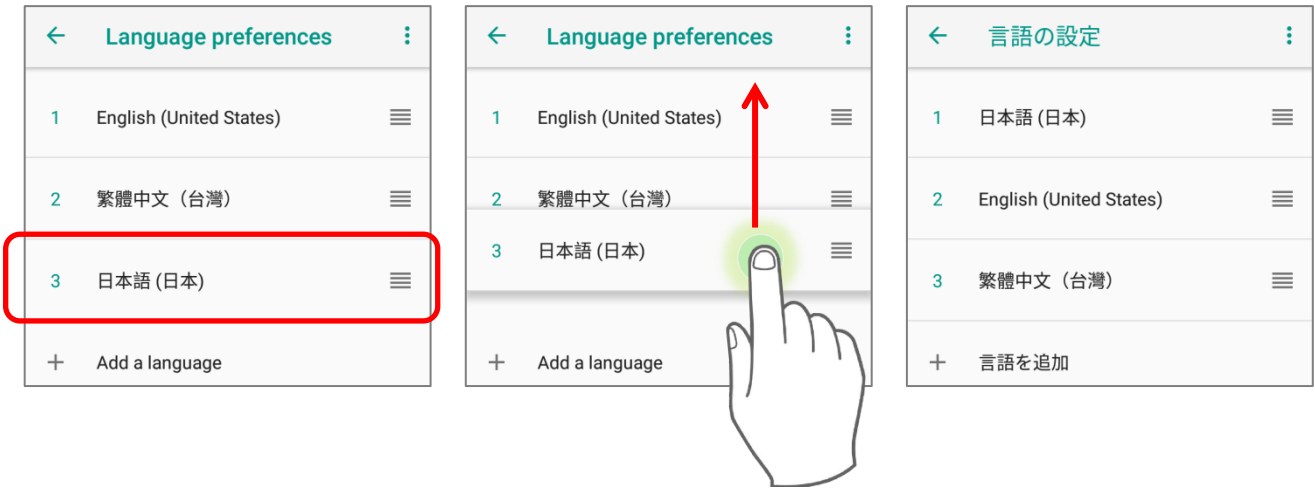

## DELETE LANGUAGE

Tap  in the upper right corner and tap "Remove" option; select the language to delete. Please note that the display language will be changed if it is selected to be deleted.

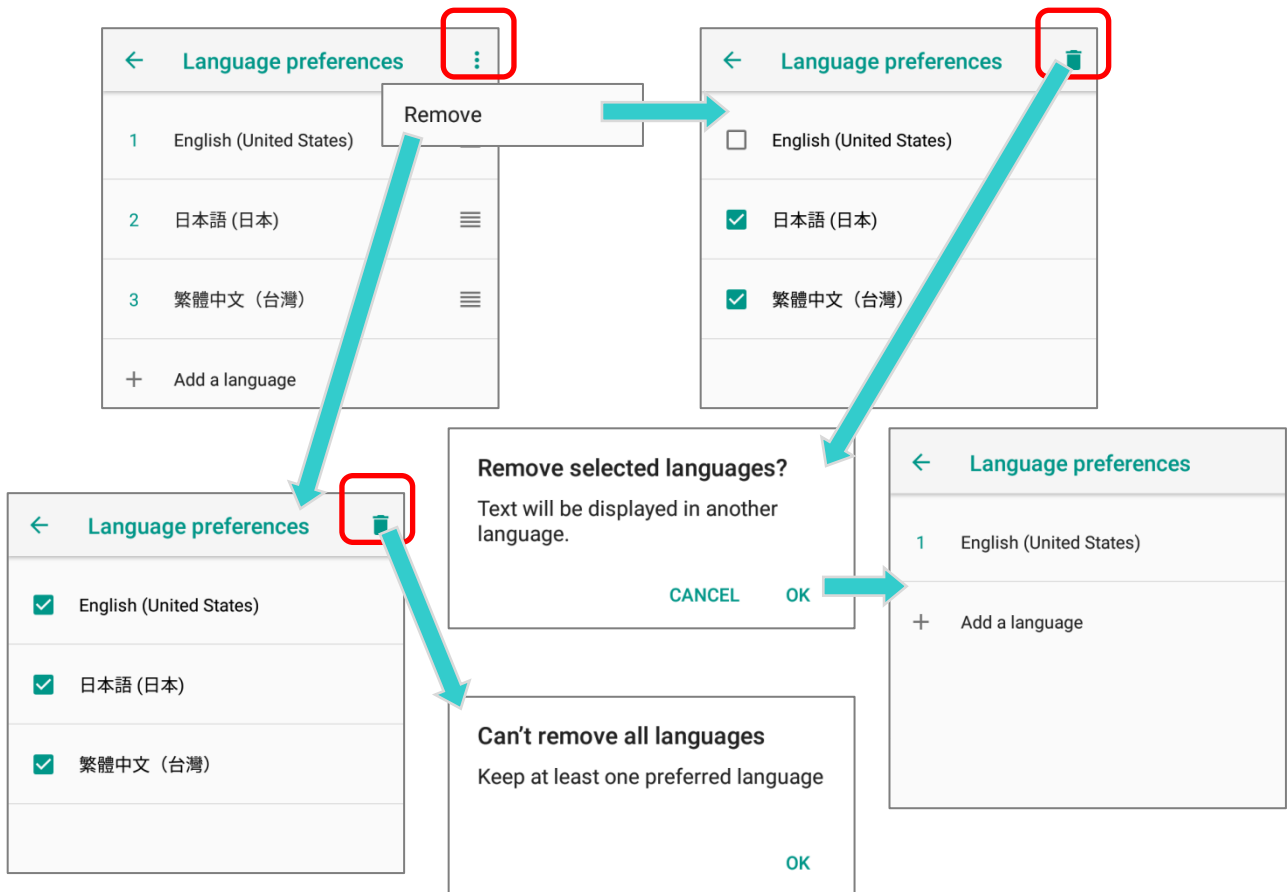

## 2.6.2. ON-SCREEN KEYBOARD

Tap a text input field to automatically open an on-screen keyboard. The virtual keyboard will vary depending on the data type (text or numbers) this field requires.

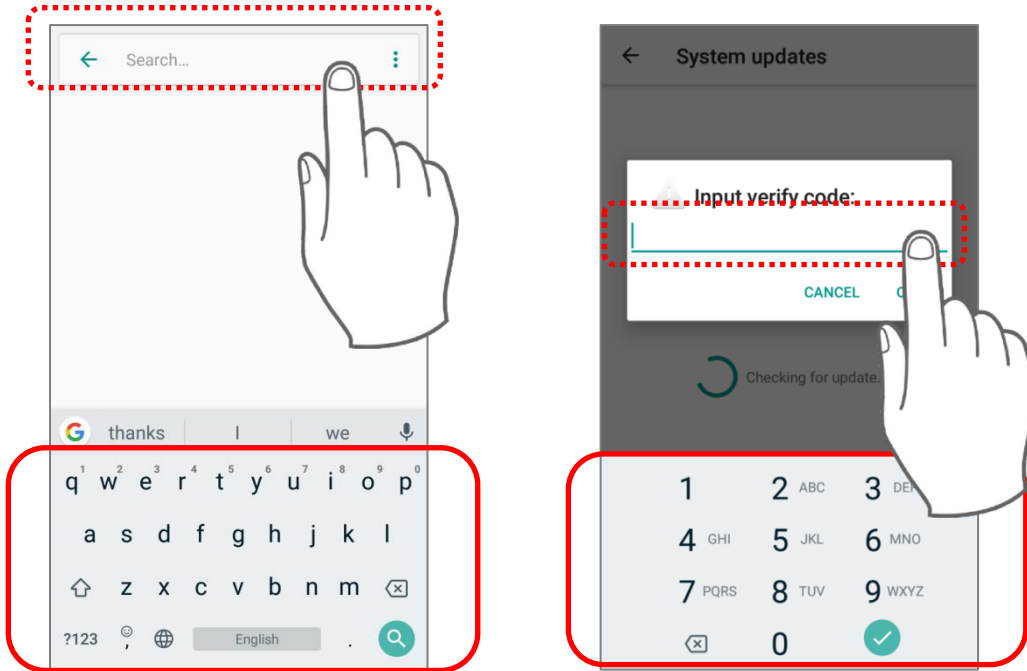

## SELECT & CHANGE KEYBOARD (INPUT METHOD)

On **Language & input** screen, select **Virtual Keyboard** to manage the installed keyboards by tapping **“Manage keyboard”** and switch on/off the input methods you need.

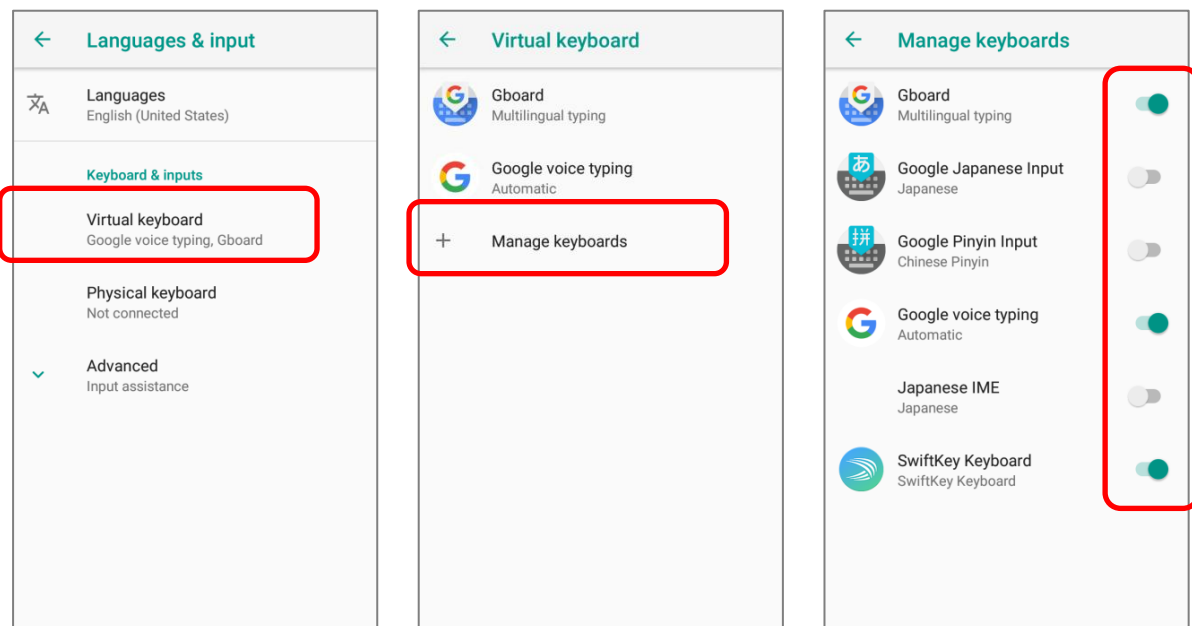

The default keyboard “**Gboard**” supports multilingual typing. To have more options of key layouts, for example, Japanese, you can:

- 1) On **Language & input** screen, tap on **Virtual Keyboard**, select **Gboard**, and then Languages.

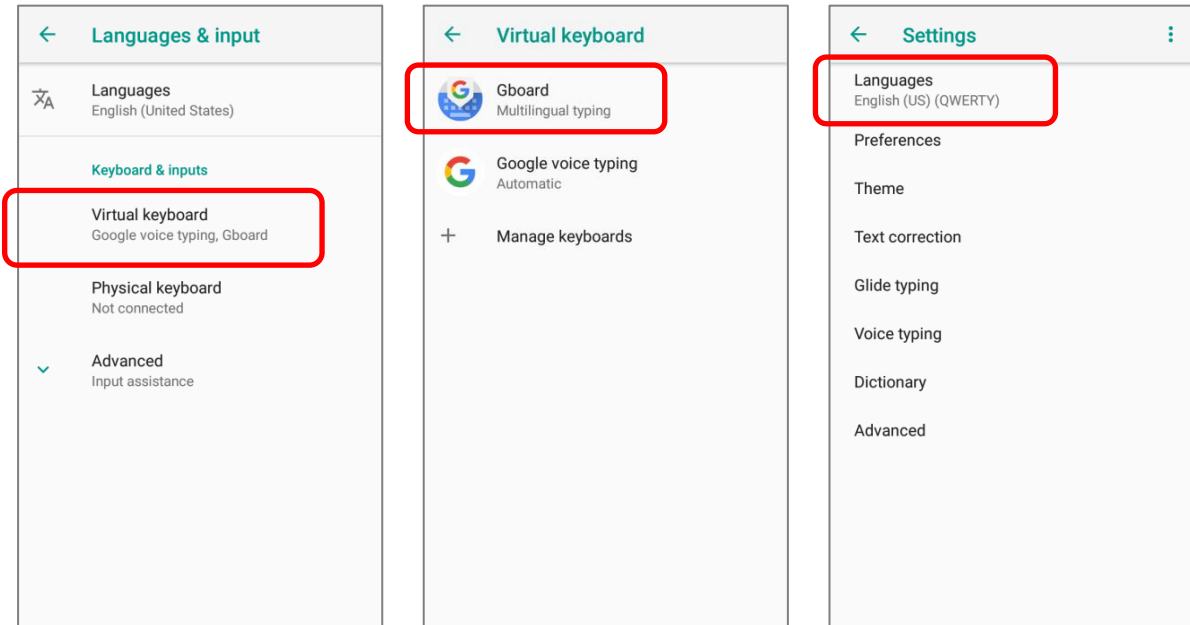

- 2) On Languages screen, tap on “**ADD KEYBOARD**”.

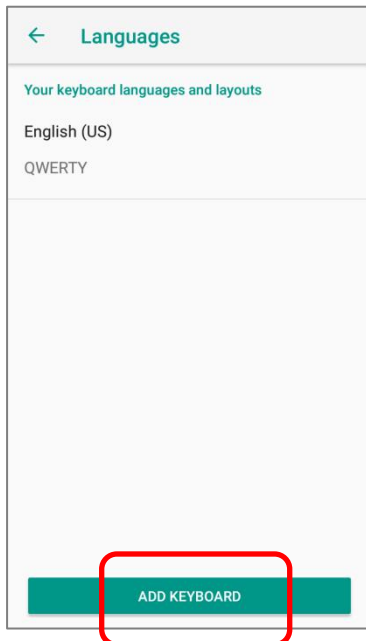



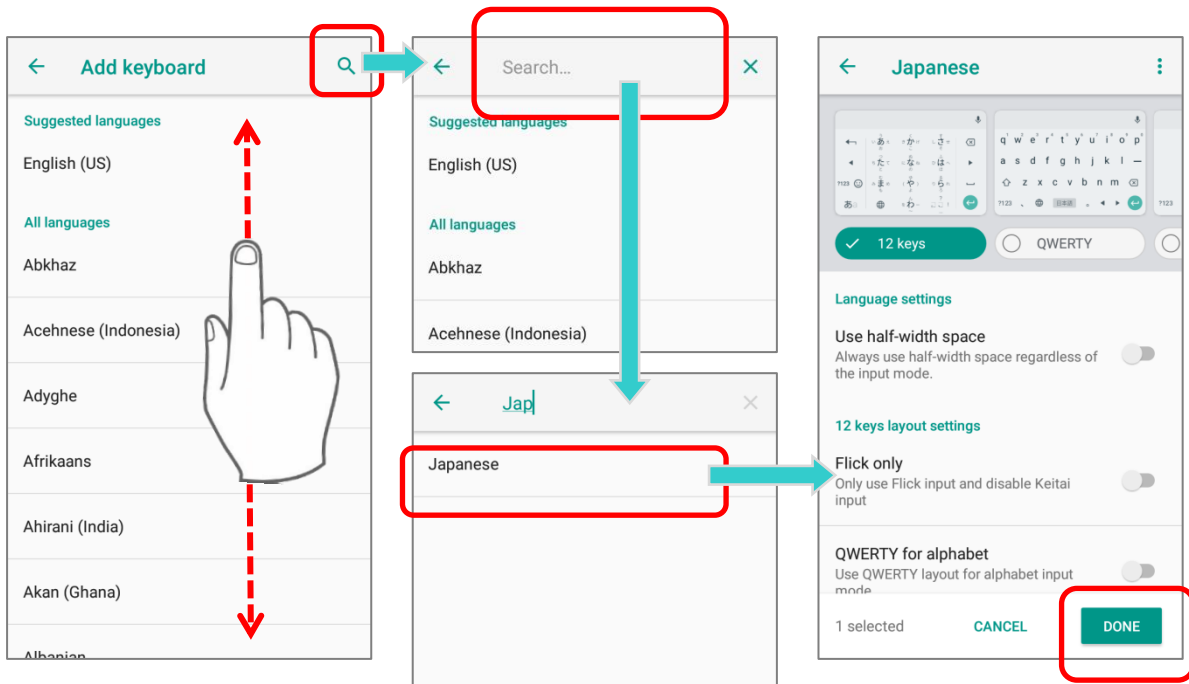

- 3) Swipe or input the keyword to search for your desired language, and tap on it to select the keypad layouts.

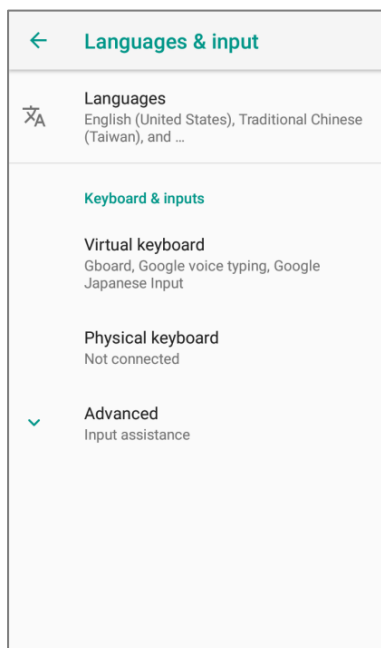

- 4) Return to **Languages** screen, and **Your Keyboard language and layouts** now lists more languages below.



## CHANGE KEYBOARD (INPUT METHOD)

Expand your **Gboard** and long press space key or  to open "**Change Keyboard**" menu and select your desired input language.

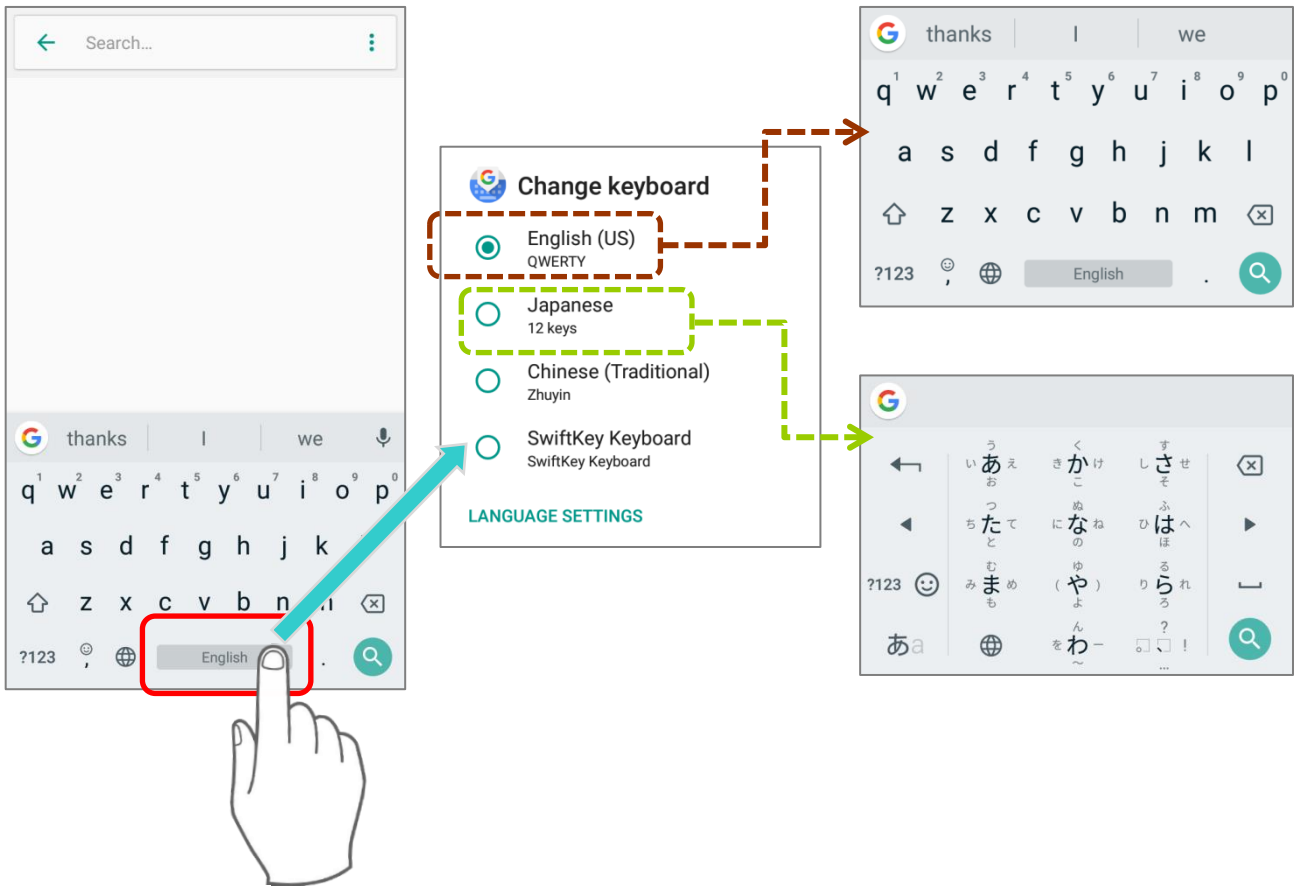

Or



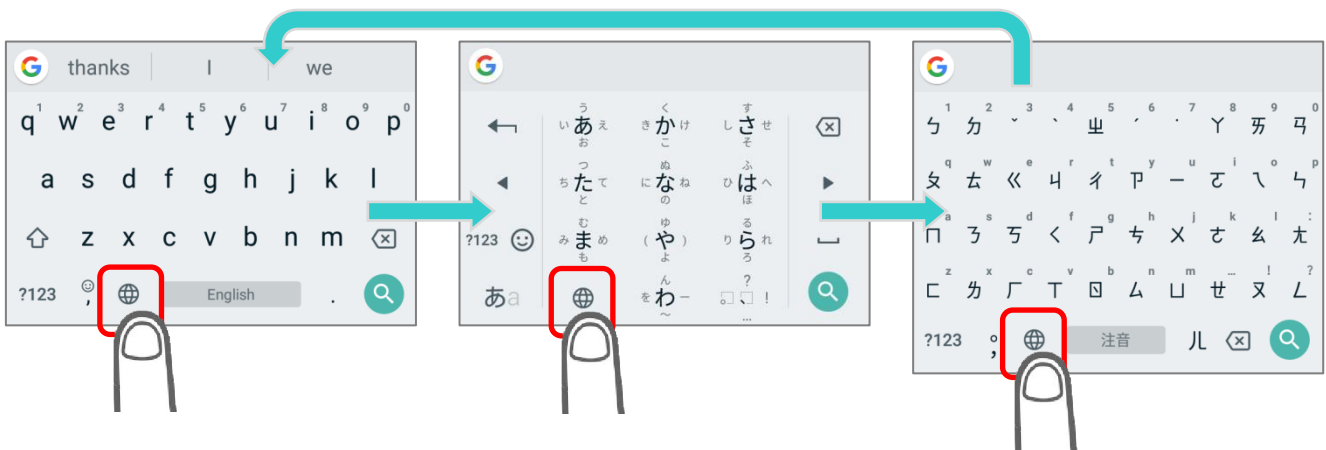

Simply tap  to cycle through the options:

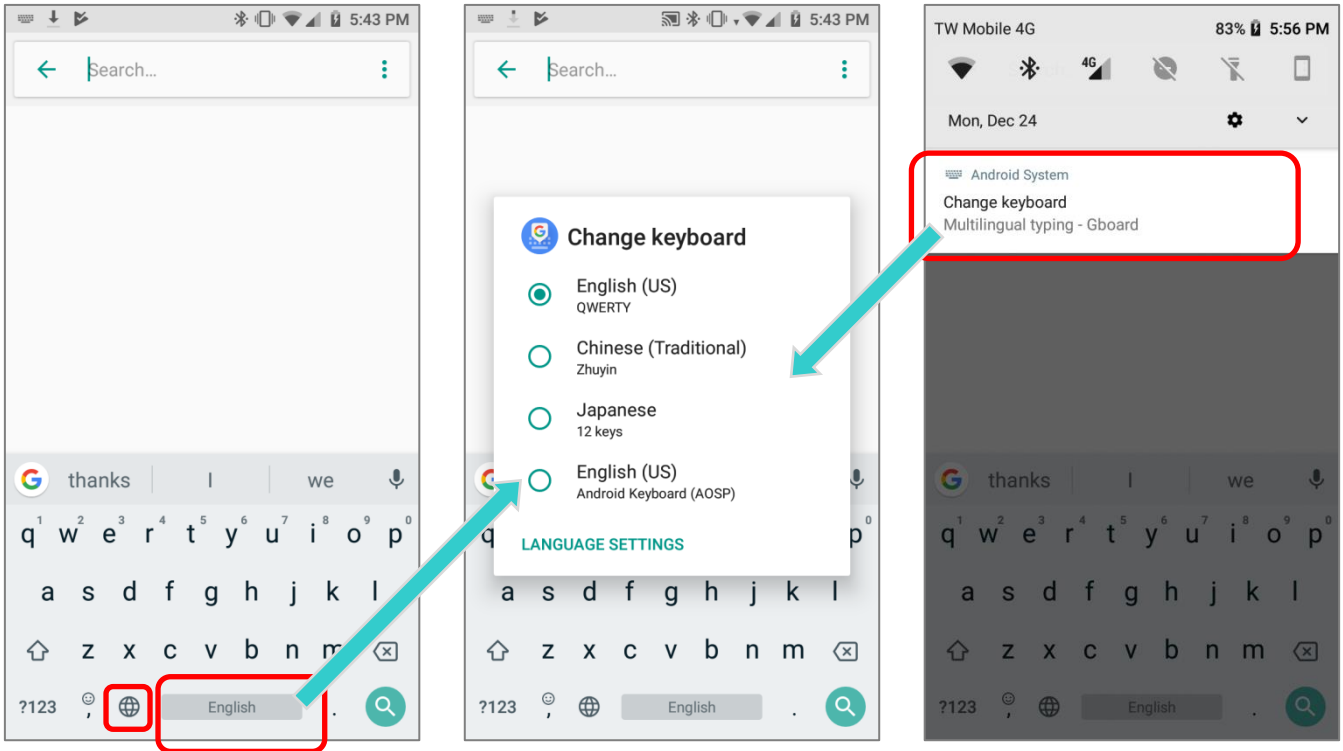

If there's any other keyboards installed by you, please long press space key or  of **Gboard** till "**Change Keyboard**" menu appears and select the keyboard you need. Or swipe down from the status bar to open **Notifications Drawer** and tap "**Change Keyboard**" notification to change it.







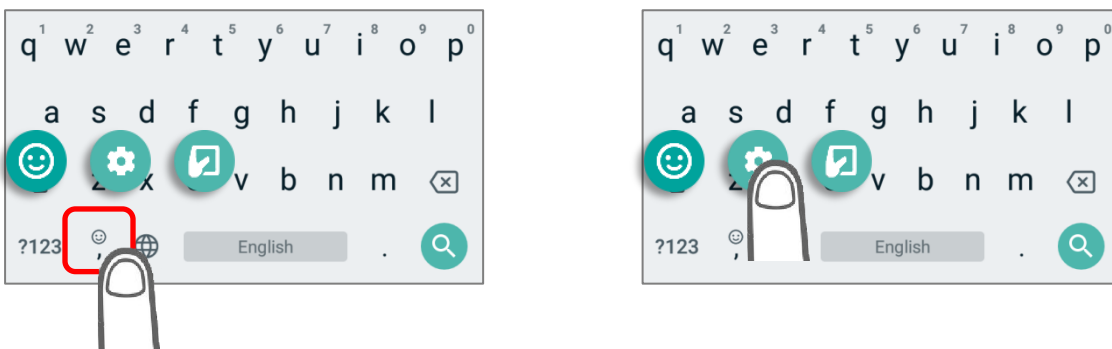

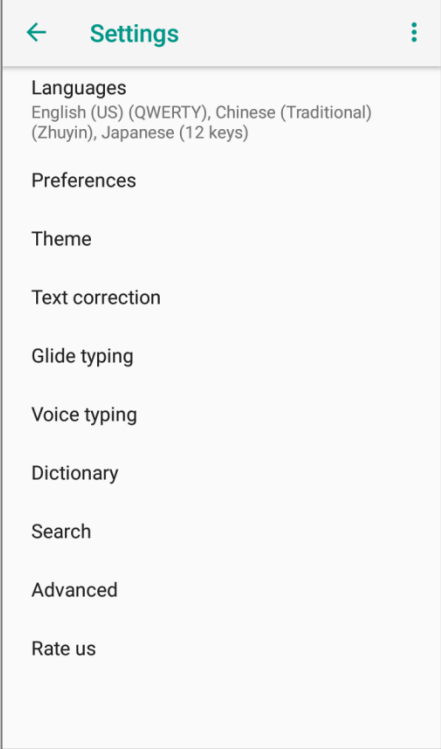

## ADJUST KEYBOARD SETTINGS

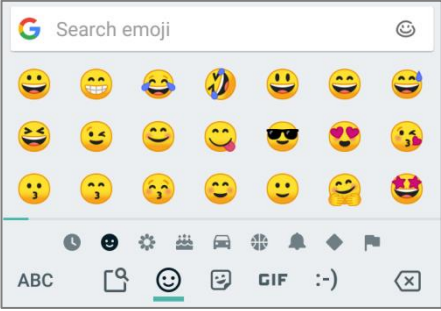
To configure keyboard settings, tap and hold the comma button  and the settings buttons    appear. Keep pressing on the screen and swipe to the button to select the function you need.

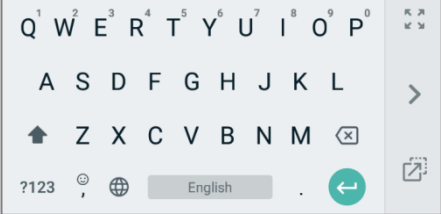

By tapping on the settings buttons, you can:

Button	Description	Figure
	<p>To enter Gboard setting page for further settings.</p>	
	<p>To show the emoji keyboard. Tap  to return to the text keyboard.</p>	
	<p>To adjust the keyboard layout to meet your need. Tap  to resume the default keyboard layout. Tap  or  to switch the keyboard layout to right-handed mode or left-handed mode. Tap  to adjust the keyboard position.</p>	

## EDIT KEYBOARD LANGUAGE (INPUT METHOD)

The keyboard language you enabled in **Gboard** can be edited from **Language & input** | **Virtual keyboard** | **Gboard** | **Languages**, and on **Languages** screen, you can add/delete keyboard languages, and change the keyboard language sorting order.

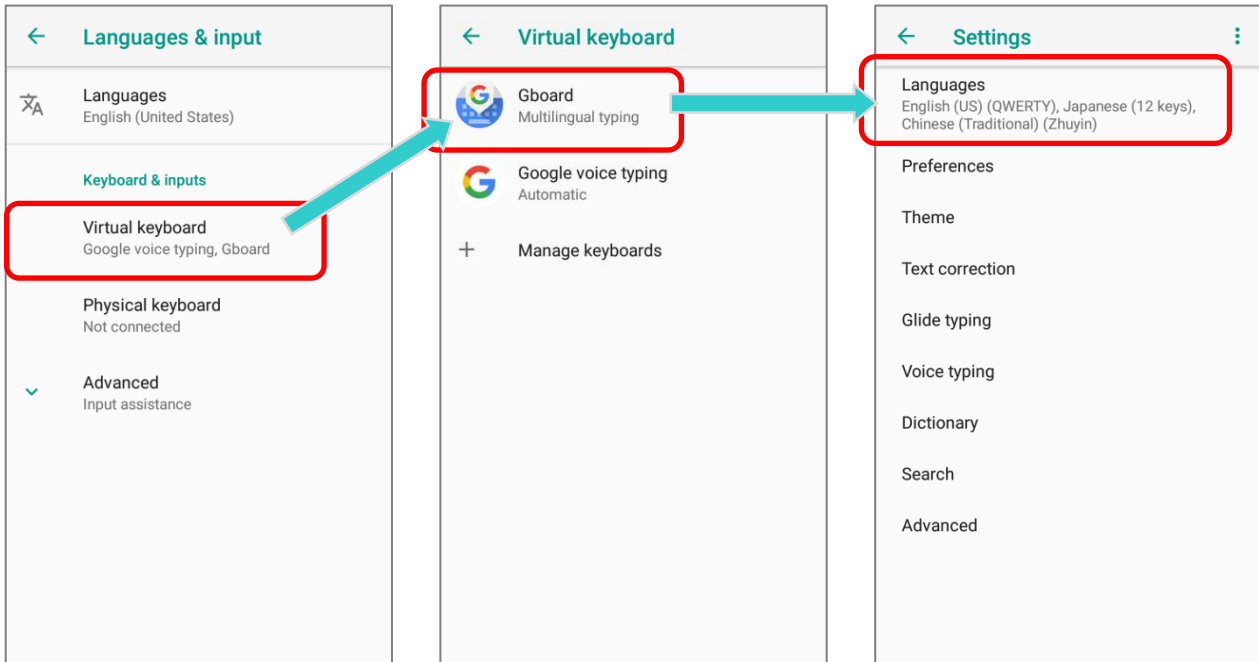

On **Languages** screen, tap on the edit icon  at the upper-right corner to enter edit mode.

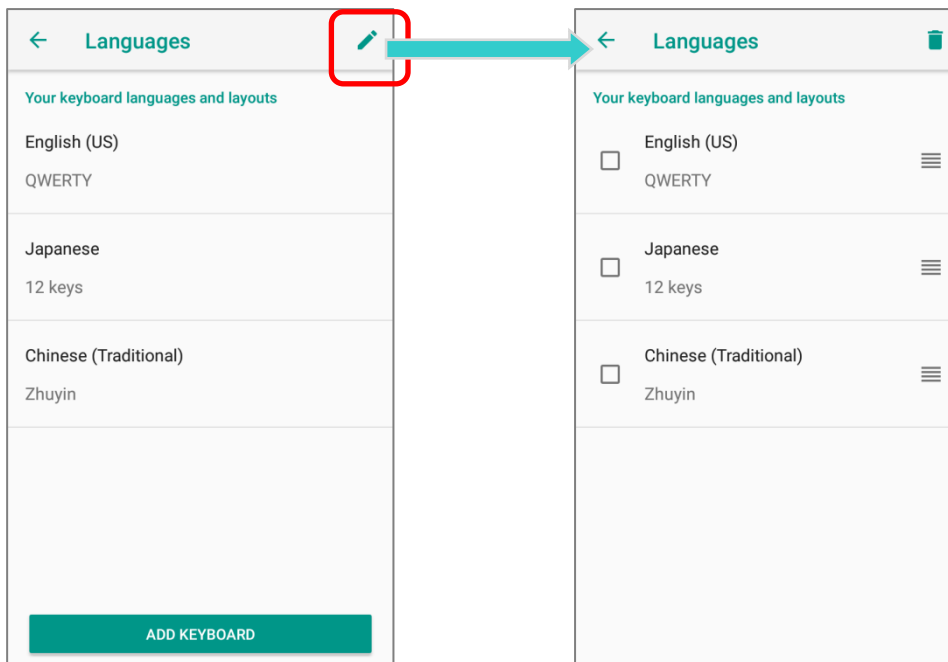

To change the keyboard language sorting order, keep pressing the language, drag it upward or downward to change its sorted position, and then release to have it placed. Return to the previous screen, and tap on any text input field to expand **Gboard** to reveal **"Change Keyboard"** menu by long pressing space key / the  button or tapping **"Change Keyboard"** notification. Now the language sorting order listed on **"Change Keyboard"** menu is changed.

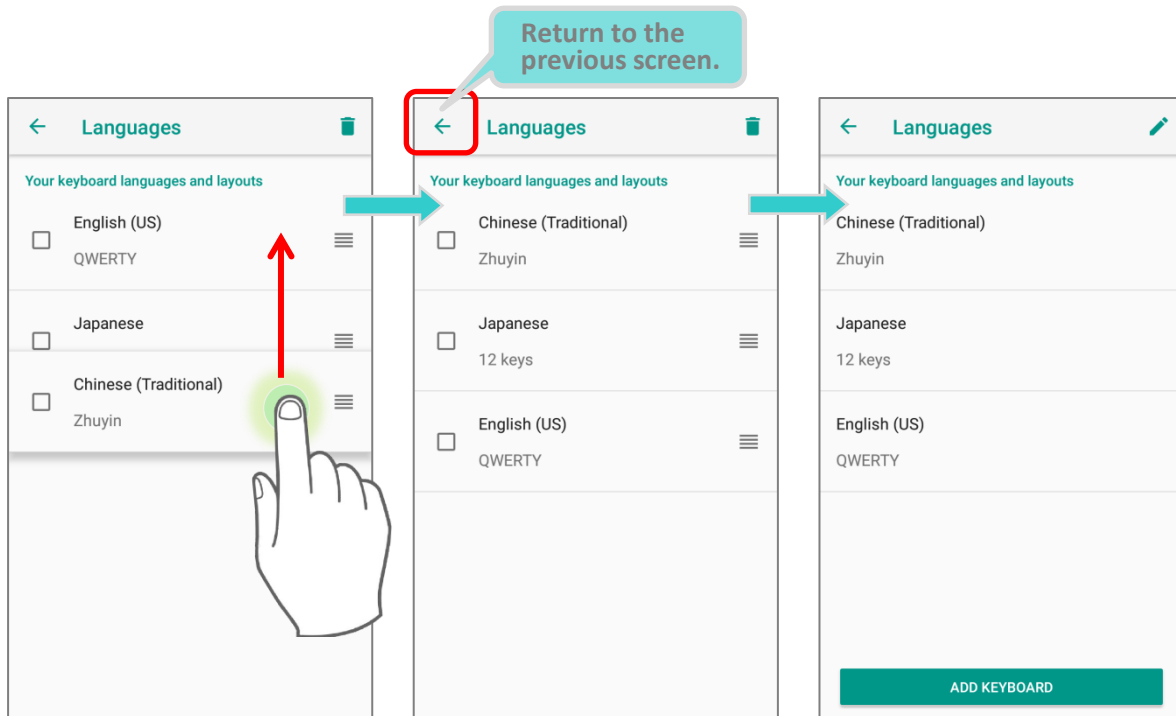

**Original Language Sorting Order**

**New Language Sorting Order**

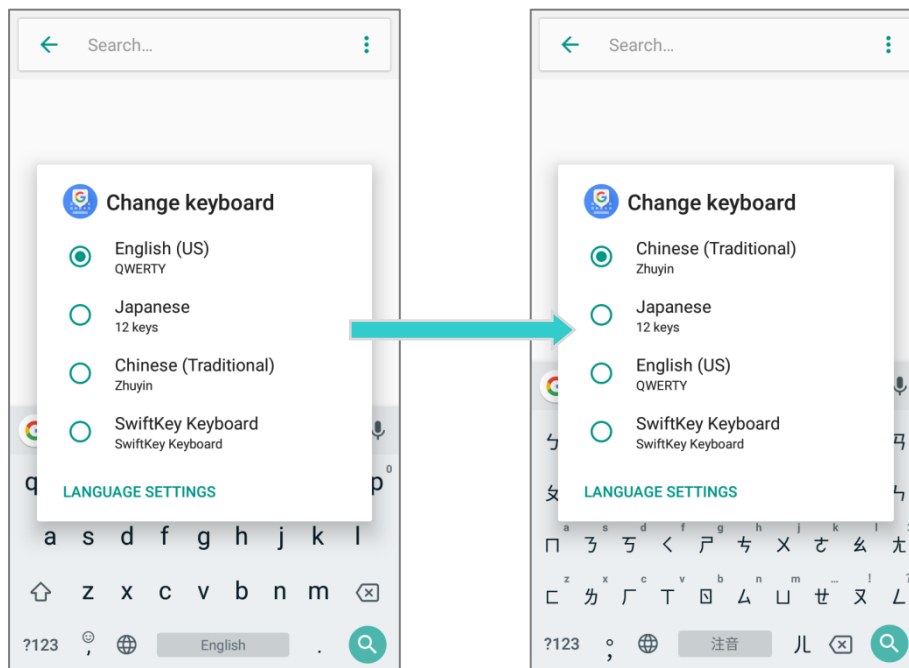

To delete keyboard language, simply tick the check box of the language(s) to be removed, and tap on the delete icon at the upper-right corner. Please note that you should keep at least one keyboard language.

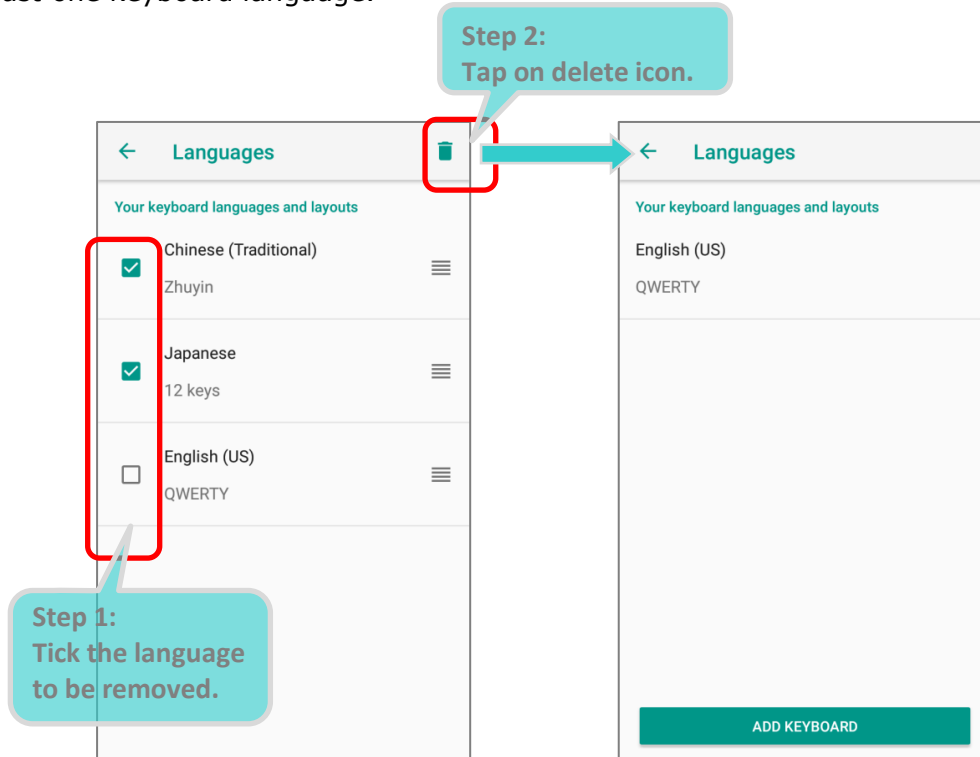

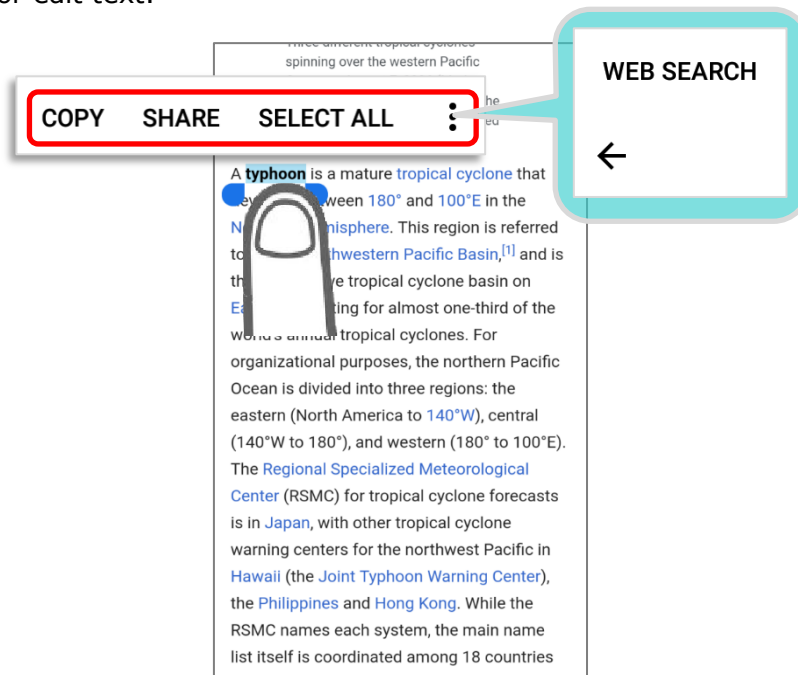

### EDIT TEXT

Tap and hold text on the screen to enable a text editing menu for selecting all text, or copying and pasting text within or across applications. Some applications may use different ways to select or edit text.



## ENTER NUMBERS AND SYMBOLS

The appearance of the switch button to numeric or symbol keyboard may vary; the example below demonstrates how to use the switch key to access your desired numeric or symbol keyboards from the default **Gboard** keyboard. To enter **Numeric / Symbol** keyboard, tap . On **Numeric / Symbol** keyboard, tap  to access more symbols or tap  to return to the **Gboard** keyboard.

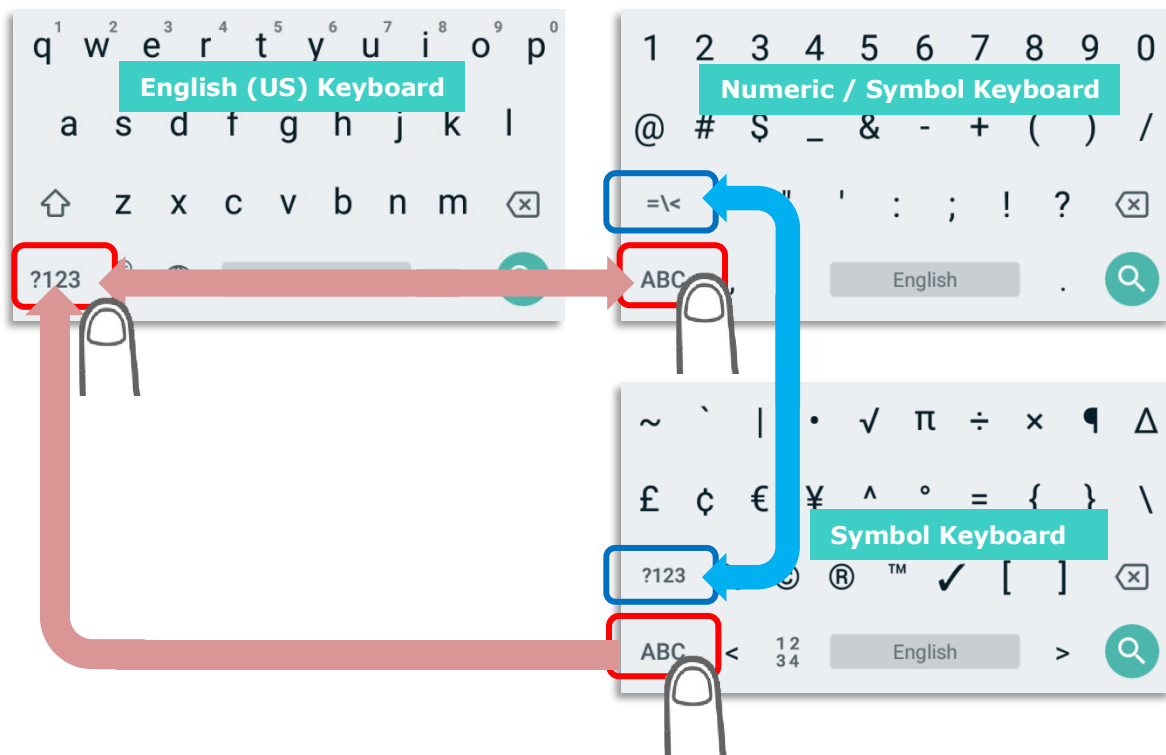

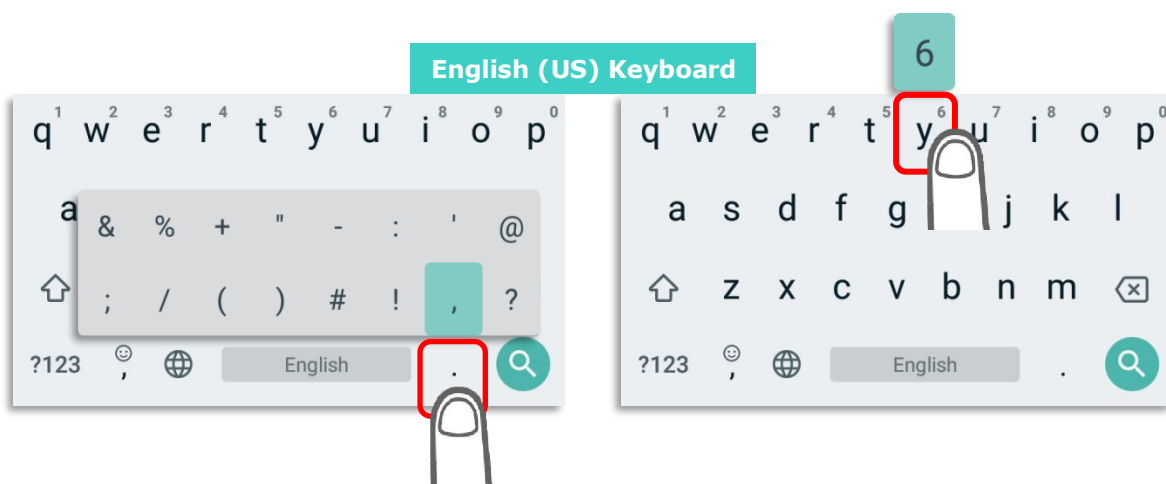

On **Gboard** keyboard, you can input number or symbols without switching to **Numeric / Symbol** keyboard.

- ▶ Tap and hold the period button  to open quick symbol keyboard.
- ▶ Tap and hold a letter from **q~p** on the top row to bring up the specific number key.







## ENTER UPPERCASE LETTERS

Tap the shift key  once to switch it to be , and tap a character key to enter an uppercase letter. The letters will return to lower case once an uppercase letter is entered.



Tap on the shift key  twice to switch it to be , and the following letters you enter will all be uppercase. Tap on the shift key again to resume lowercase keyboard.



Or, directly input the words and then tap on the word to highlight it and tap on shift. You can capitalize all the whole word or just the first letter by tapping on the shift key.

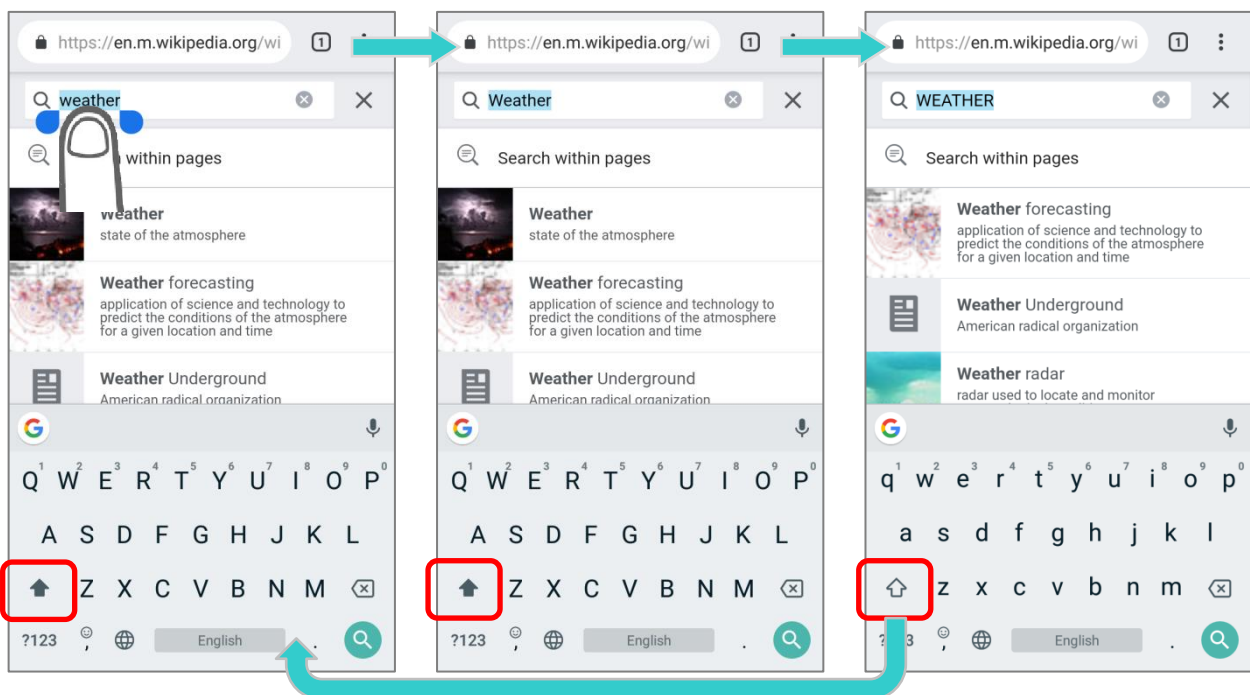

**2.7. SOUND AND VOLUME**

Use the volume buttons on the left side of the mobile computer to adjust system and ringer volume.

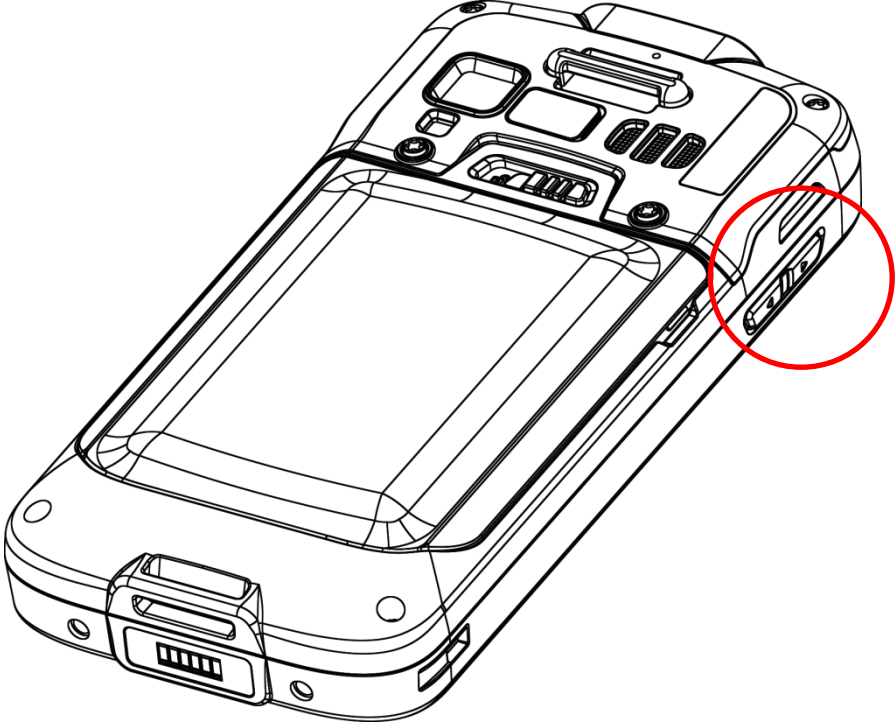

## 2.8. BUTTON ASSIGNMENT

Tap [App Drawer \(All Apps\)](#) | **Settings**  | **System**  | **Button Assignment**  to assign specific functions to the following programmable keys:

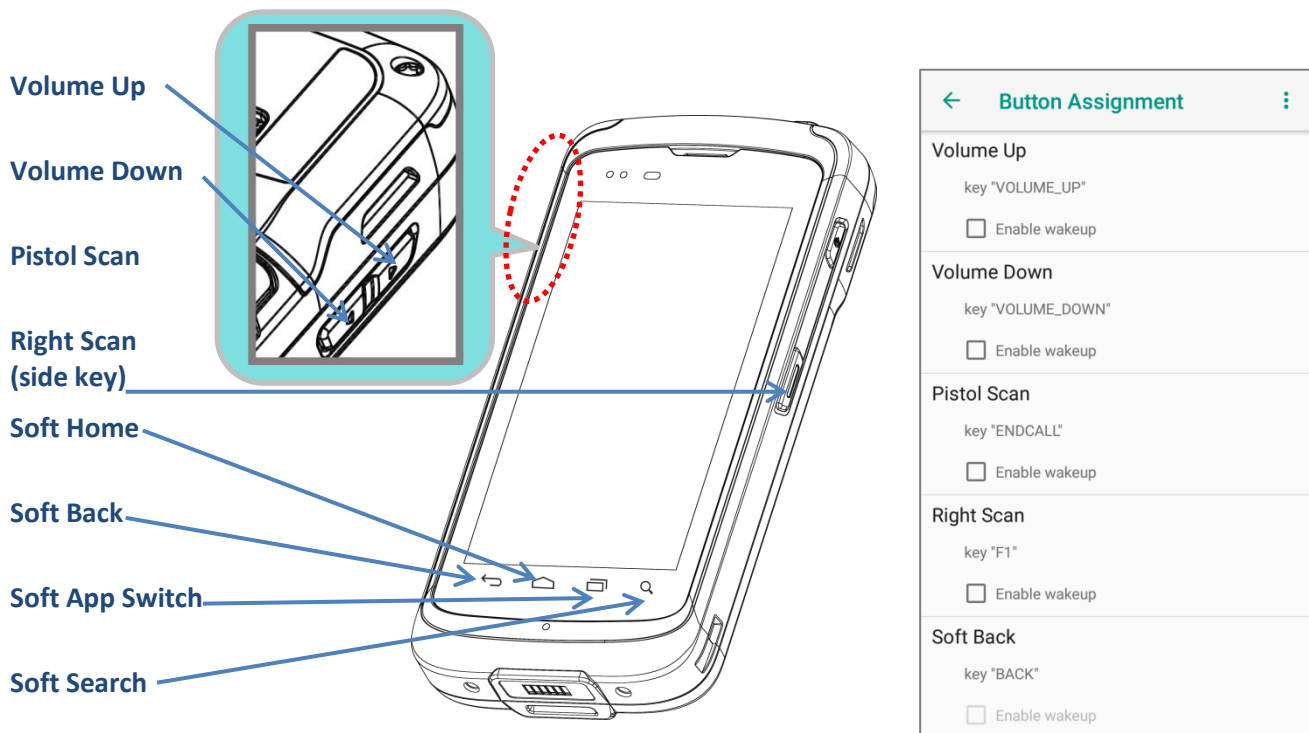

After redefining the programmable keys, the changes will immediately take effect.

### ENABLE WAKEUP

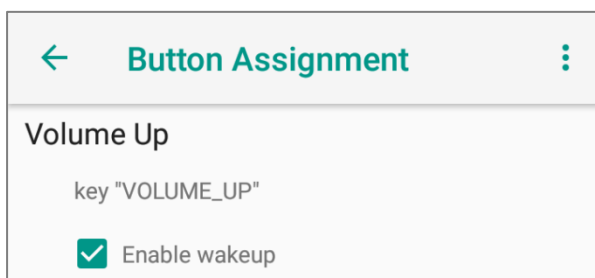

Select the **Enable wakeup** to enable pressing the key to wake the mobile computer from suspend mode.

**Note:** This selection is automatically disabled if an application is selected for the key on the Apps tab page.

**ASSIGN KEYCODE**

Tap the key you would like to assign. A screen opens showing a list of available keycodes or applications. On the **Keycodes** tab page, scroll down to view the entire list of keycodes, and tap a keycode to apply.



The screenshot shows a mobile application interface titled "Button Assignment". At the top left is a back arrow icon. Below the title are three tabs: "KEYCODES" (which is selected and highlighted with a red underline), "APPS", and "INTENT". The main content area is a list of keycodes, each in a separate row. The list includes: NONE, SOFT\_LEFT, SOFT\_RIGHT, HOME, BACK, CALL, ENDCALL, 0, 1, 2, 3, 4, 5, 6, and a partially visible 7 at the bottom.

KEYCODES	APPS	INTENT
NONE		
SOFT_LEFT		
SOFT_RIGHT		
HOME		
BACK		
CALL		
ENDCALL		
0		
1		
2		
3		
4		
5		
6		
7		

## ASSIGN APPLICATION

Tap the key you would like to assign. Tap the **Apps** tab page to open a list of available applications. Scroll down to view the entire list of applications, and tap an application to apply.

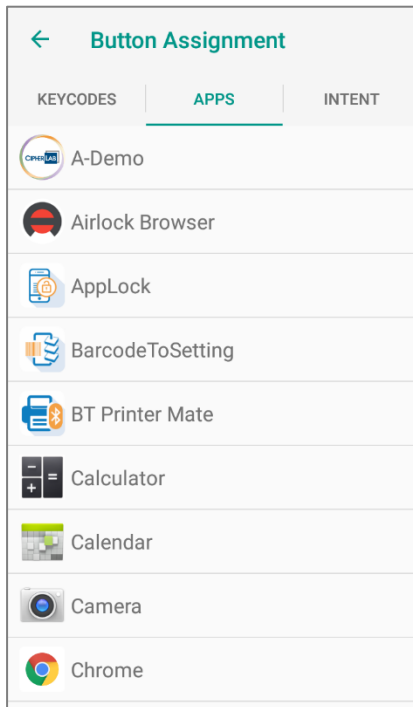

After an application is selected, an icon will appear under the assigned key. Also, the **Enable wakeup** checkbox will be automatically disabled.

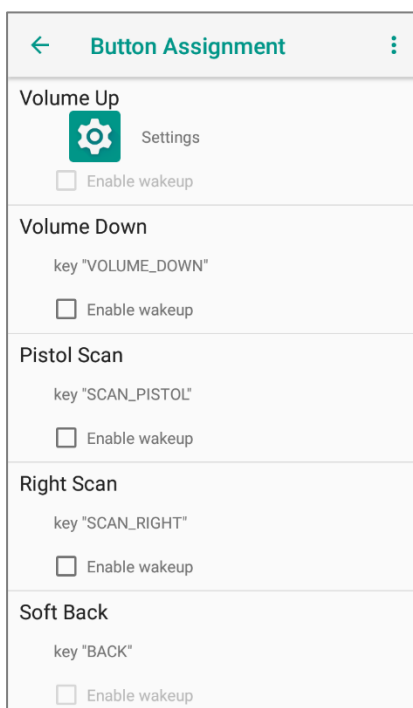

## ASSIGN INTENT

You can make use of the *intent* (the specific intent string should be input beforehand in the configuration xml file on your device) to assign a hardware key to launch a specific application. When you press this hardware key, this App will be launched by this intent.

On the *Intent* screen, input the name of the Intent and then tap on "**Commit**".

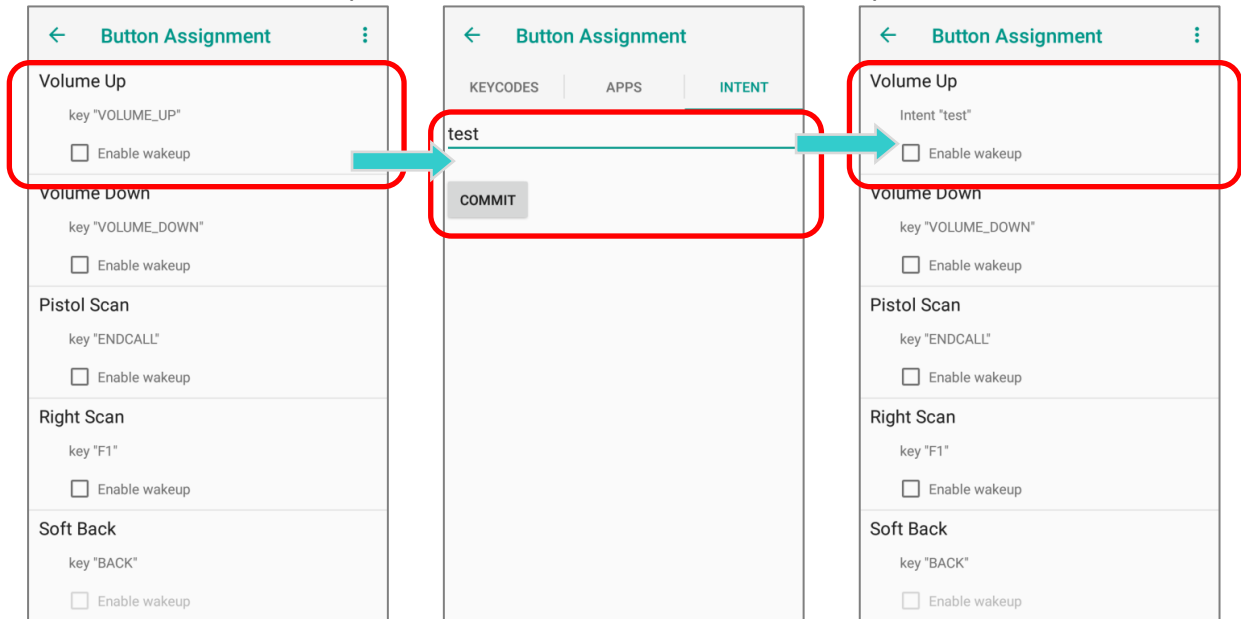

## IMPORT AND EXPORT SETTING

After finishing configuring the keys, you can save the setting to a *txt* (XML format) file, allowing you to apply the same setting to other devices. To do this, tap *More* and then "**Export**". This file will be exported to the root folder of the device's internal storage as "*keys\_config.txt*".

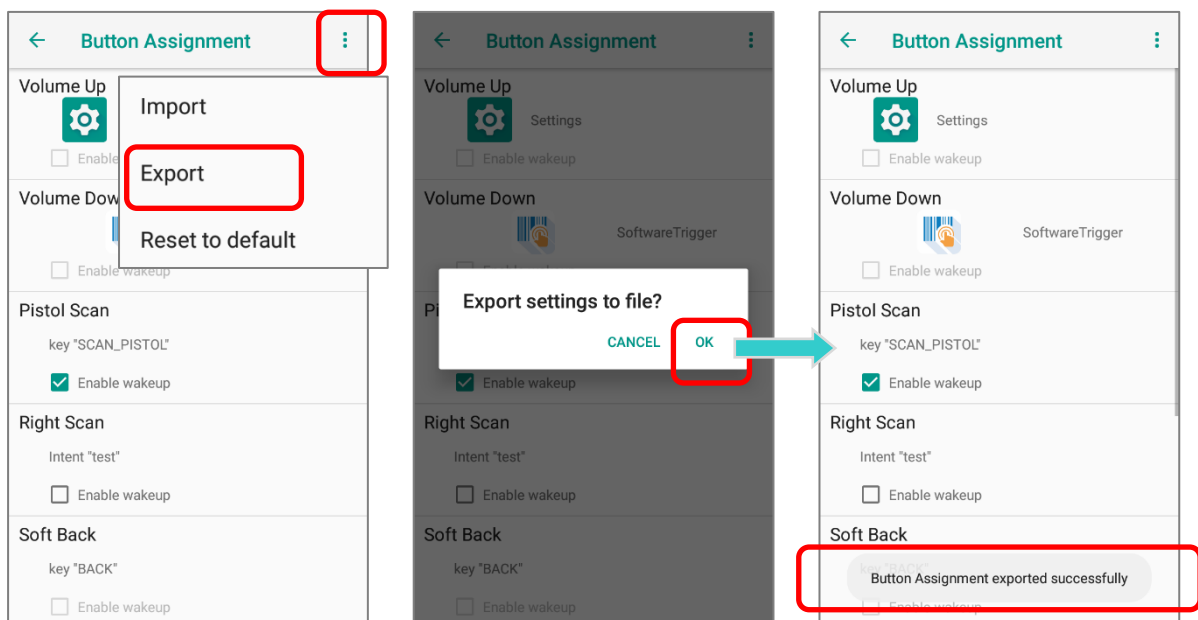

To share this exported file with other devices, please make sure the filename is not renamed.

Tap the file name till the **"Action"** menu appears, and select **"Send"** and then select a file-sharing method from **"Send with"** menu.

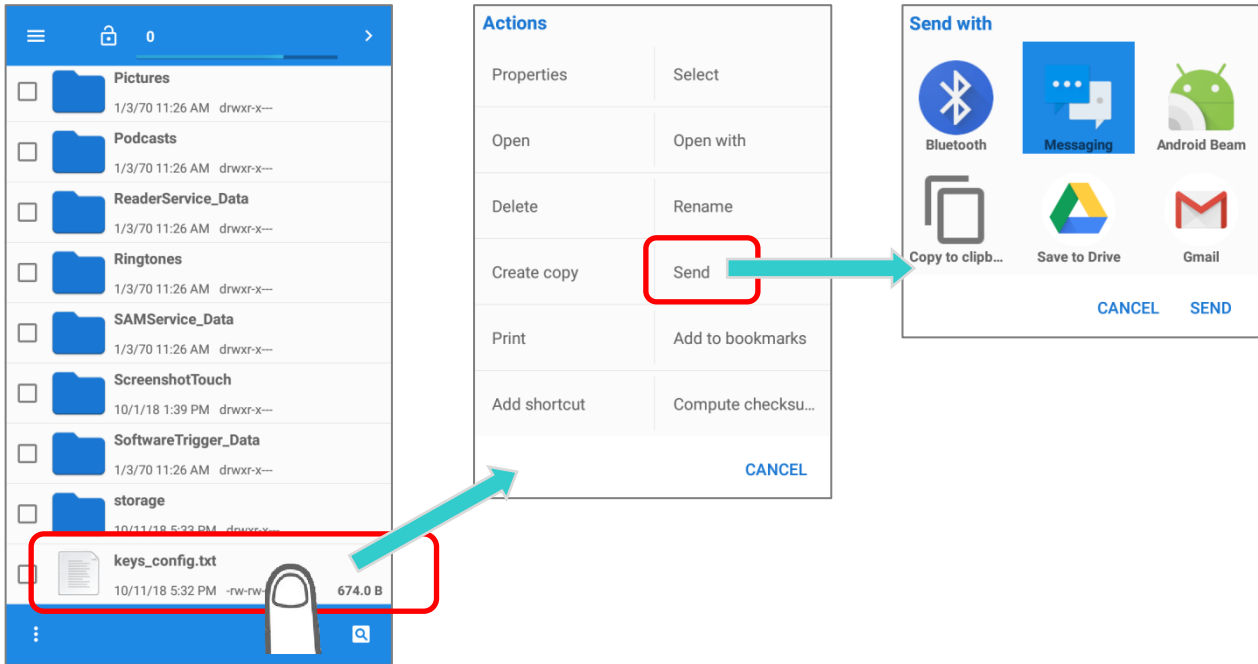

**OR**

Tick the checkbox of this exported file, and tap on the more button  to open the **"Action"** menu. Tap on **"Send selection"** and select a file-sharing method from **"Send with"** menu.

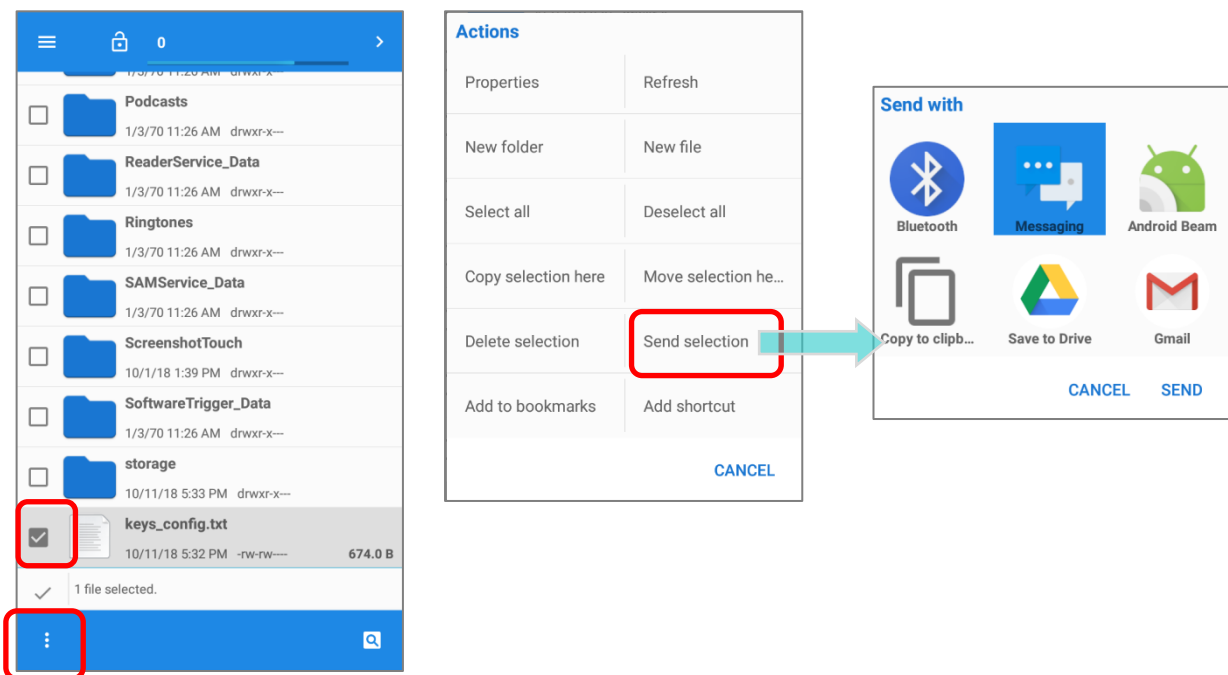

To import the configuration file to be used in **Programming keys**, make sure the file is saved in the root folder of the device's internal storage with the file name **keys\_config.txt**. On the **Button Assignment** screen, tap on **More** and then **Import**. The new setting will be immediately applied to the keys.

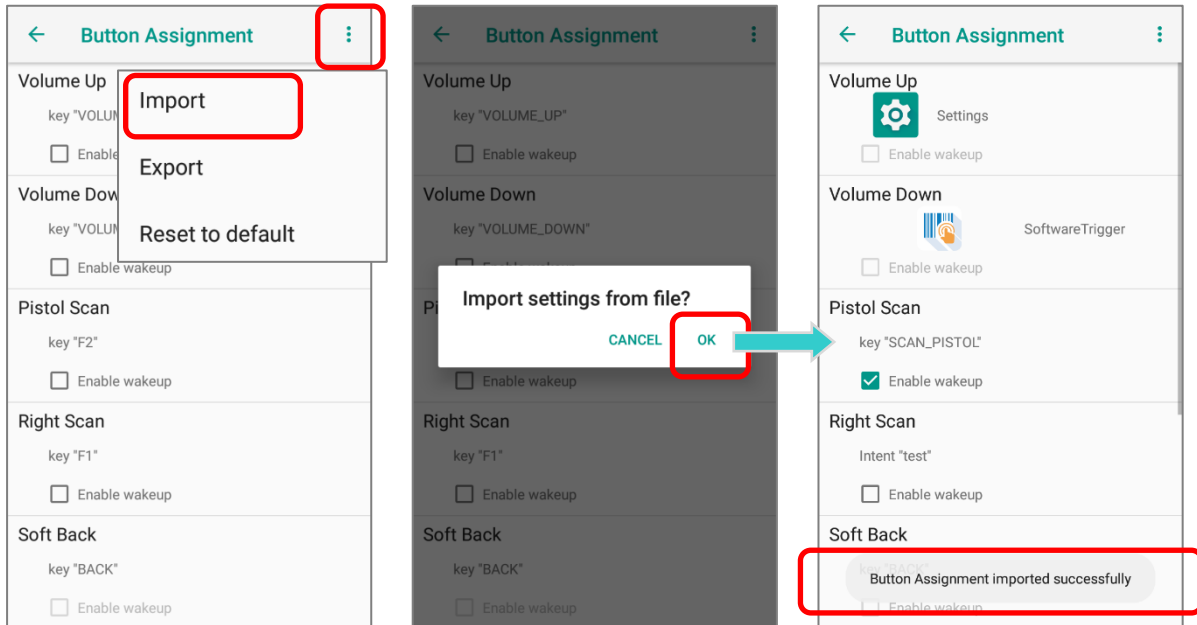

## RESET TO DEFAULT

Tap to reset the buttons settings to the default.



## 2.9. DATA CAPTURE

### 2.9.1. BARCODE READER

A selection of scan engines is available for delivering flexibility to meet different requirements. Depending on the scan engine integrated, the mobile computer is capable of scanning barcodes of a number of symbologies that are enabled by default while running the ReaderConfig application. If you need to scan barcodes that are encoded in a different symbology, enable the symbology first.

### 2.9.2. DIGITAL CAMERA

An integrated 13 megapixels rear camera in the mobile computer is specifically designed for collecting image data. You may use the image capture utility to turn on the camera and capture images. By default, the images taken by this camera application are saved as JPG files in the **DCIM** folder in the device's primary storage.

## BASIC OPERATION

---

This chapter describes the basic skills to work with the RS51 mobile computer, for instance, on how to operate the home screen, check system statuses and manage notifications. The add-on utilities for applications regarding data collection, processing, and transmission are introduced in the following chapters.

### IN THIS CHAPTER

---

3.1 Home Screen.....	91
3.2 Status Bar.....	94
3.3 Manage Applications.....	101
3.4 Suspend & Lock .....	106
3.5 OS Update .....	108
3.6 Back up Your Data .....	110
3.7 Reset to Factory Default .....	112

### 3.1. HOME SCREEN

When the mobile computer is fully charged, press the Power key for three seconds to turn on the mobile computer. A locked screen will appear. Slide the lock button  upward to unlock the screen.

The Home Screen appears showing **a status bar, shortcut icons**, an icon to open **App Drawer**, and the **Favorites tray**. The home screen allows multiple pages for placing shortcut icons and widgets. You may customize the home screen according to your preferences.

To open **App Drawer**, please tap  icon, or slide up from the Favorites Tray.

#### 3.1.1. CUSTOMIZE HOME SCREEN

##### ADD APPLICATION SHORTCUT TO HOME SCREEN

- 1) On the home screen you would like to customize, tap open **App Drawer** icon  , or slide up from the **Favorites tray**.
- 2) Locate the application to add, tap on and hold the application icon.
- 3) The home screen will appear. Drag the application icon to your preferred position and release to have it placed.

Long pressing certain applications such as Chrome or Gmail™ may show the **app shortcuts** but not Home screen. To add such applications from App Drawer to your Home screen, please:

- 1) Keep tapping and holding the application icon and drag it upward.
- 2) The Home screen will appear. Drag the application icon to your preferred position and release to have it placed.

##### ADD WIDGET TO HOME SCREEN

- 1) Tap and hold any empty spot on the home screen.
- 2) The current layout will shrink, and the available options related to home screen appear on the bottom. Tap **Widgets** to enter the widget selection list.
- 3) In the **widget** selection list, scroll to locate your desired widget.
- 4) Tap and hold the widget until the home screen layout appears. Drag the widget to your preferred position and release to have it placed. For a setting shortcut, you will have to select a specific setting from the shortcuts list.

---

## ARRANGE THE SHORTCUTS AND WIDGETS ON HOME SCREEN

To move or remove a shortcut/widget, on the home screen you would like to customize, tap and hold it to enter layout edit mode, an option "**X Remove**" will appear on top of the screen, to which you can drag the unwanted shortcut/widget to remove it. Drag the icon to the preferred position and release it to have it placed.

To resize a widget, tap and hold it until a white frame appears. Tap and drag a white dot to re-scale the widget.

---

## ARRANGE THE APPLICATIONS WITH APP SHORTCUTS ON HOME SCREEN

To move or remove those applications which offer **app shortcuts**, please hold and drag the application icon to anywhere on the screen, and layout edit mode appears. Drag the application icon to "**X Remove**" on the top of the screen to remove it, or to the preferred position and release it to have it placed.

To create an Action icon from the app shortcuts to Home screen, please:

- 1) Long press an application icon (no matter on the **Home screen** or the **App Drawer**) to unfold its app shortcuts.
- 2) Tap and hold an **Action** from the app shortcuts and drag it to the preferred position on the Home screen.
- 3) Release the **Action** icon to have it placed.

---

## EDIT FAVORITES TRAY

**Favorites Tray**, which is located in the bottom of Home screen, contains up to **5** icons and appears on every Home screen.

Add **Widgets**, **Applications**, **Actions**, or **Folders** to Favorites Tray, please:

- 1) Tap and hold the icon and drag it to the Favorites Tray.
- 2) Release the icon to have it placed.

To move/remove an icon of **Widgets**, **Applications**, **Actions**, or **Folders** from the Favorites Tray:

- 1) Tap and hold the icon to enter layout edit mode.
- 2) Drag the icon to the spot where you would like to have it place and release it, or drag it to "**X Remove**" on the top of the screen to delete it.

### CHANGE HOME SCREEN WALLPAPER

- 1) Tap and hold any empty spot on the home screen.
- 2) Tap Wallpapers in the menu that appears, and select the app you would like to use.
- 3) Select an image to apply as the wallpaper.
- 4) Tap Set wallpaper.

### CREATE FOLDER

- 1) On the home screen you would like to customize, tap and hold the application shortcut you would like to move, drag the icon on the top of another icon to create a folder.
- 2) As these icons overlap, a folder is created.
- 3) After you let go your finger, these icons are enclosed in a circle.

### NAME A FOLDER

- 1) Tap the folder you would like to name.
- 2) The folder will expand from a small circle to a full rectangle to show all the shortcuts in it. Tap "**Unnamed Folder**" and edit the folder name.
- 3) Tap **Done**  on the on-screen keyboard.
- 4) Tap elsewhere on the screen, the folder will shrink to a small circle with its new name.

### REMOVE A FOLDER

- 1) Tap and hold the folder you would like to remove.
- 2) Drag the folder to the top of the screen where the option "**X Remove**" is located.

---

#### Note:

Please note that, when you remove a folder, the shortcuts contained in it will be removed as well.















---

## 3.2. STATUS BAR

The left side of the status bar shows **notification icons**, and the right side of the status bar shows **status icons**.















### 3.2.1. ICONS ON STATUS BAR

#### STATUS ICONS

Icon	Description
	Bluetooth is on.
	The device has been connected to a Bluetooth device.
	The device is currently connected to a Wi-Fi network and performing data transmission.
	No mobile network signal
	The device is currently connected to a 4G network. A symbol will be shown on the left to indicate the cellular data connection type (e.g. 3G).
	Full mobile network signal
	Airplane mode is active, which means all radios are inactive now.
	Alarm is active.
	No SIM card is inserted
	All sounds are silent except for alarms (Vibration mode).
	The main battery is fully charged.
	The main battery is partially drained.
	Main battery level is very low and needs charging immediately (<5%).
	External power source is connected and main battery is being charged.

---

**NOTIFICATION ICONS**

Icon	Description
	USB debugging mode is enabled on this device
	The device is performing data synchronization.
	There is an upcoming event.
	The device is downloading data.
	The device is uploading data.
	An open Wi-Fi network is available.
	A memory card has been inserted.
	There has been a problem. Open Notifications Drawer for more details. For example: No SIM card detected in either of the two SIM card slots
	The headset has been inserted.
	The phone call is connected.
	There has (have) been missed call(s).
	The current phone call has been paused.
	Wi-Fi hotspot is active.
	Bluetooth tethering is active.
	USB tethering is active.

### 3.2.2. OPEN QUICK SETTINGS MENU

The status icons are related to essential settings regarding the device's remaining power, Bluetooth status or Wi-Fi connectivity status. The status bar offers a quick access for you to easily make adjustments of the settings. To open **Quick Settings menu**, use you two fingers, swipe from the top to the bottom of the screen. You can tap on each status icon on the menu to switch among different modes or enter the settings

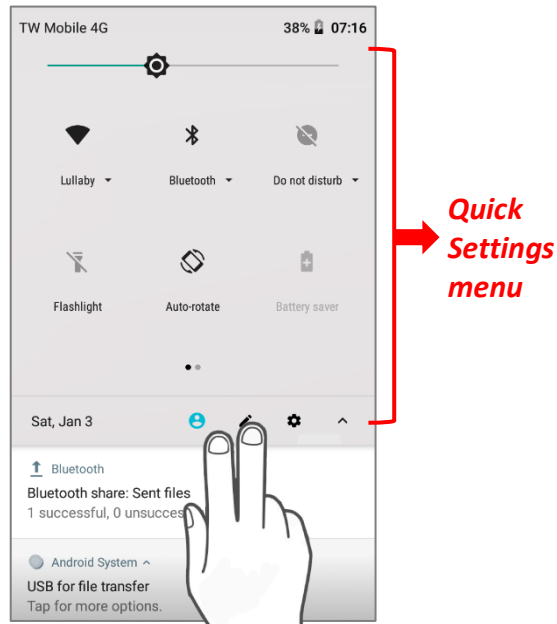

OR

- 1) Swipe down form the status bar by one finger to open **Notifications Drawer**.
- 2) Click **▼** icon on **Quick Settings Panel** to open **Quick Settings Menu**.

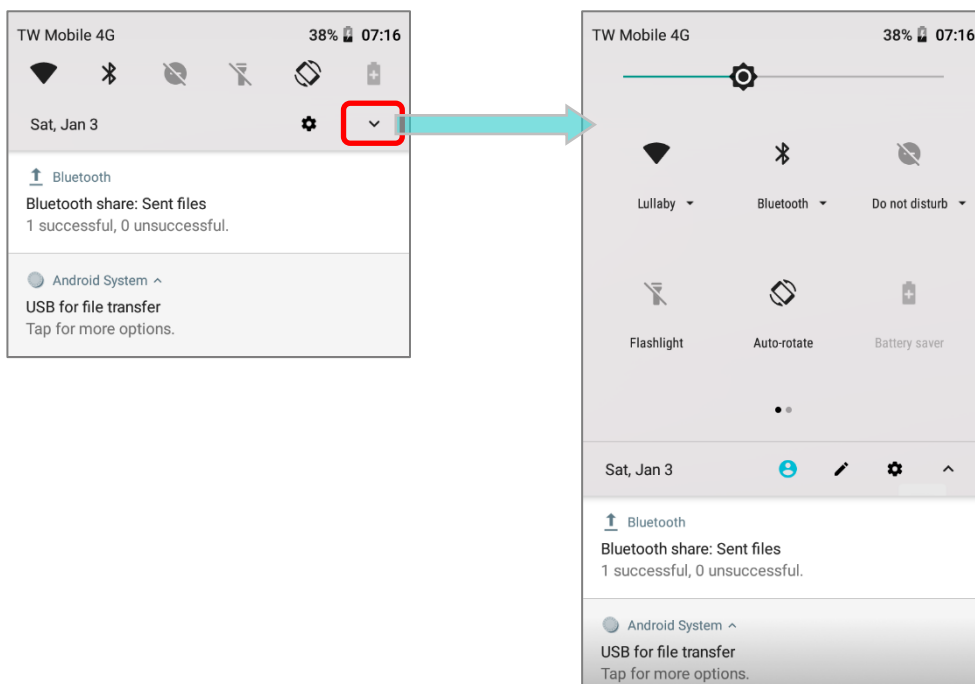





## EDIT QUICK SETTINGS MENU

To customize **Quick Settings Menu**, please:

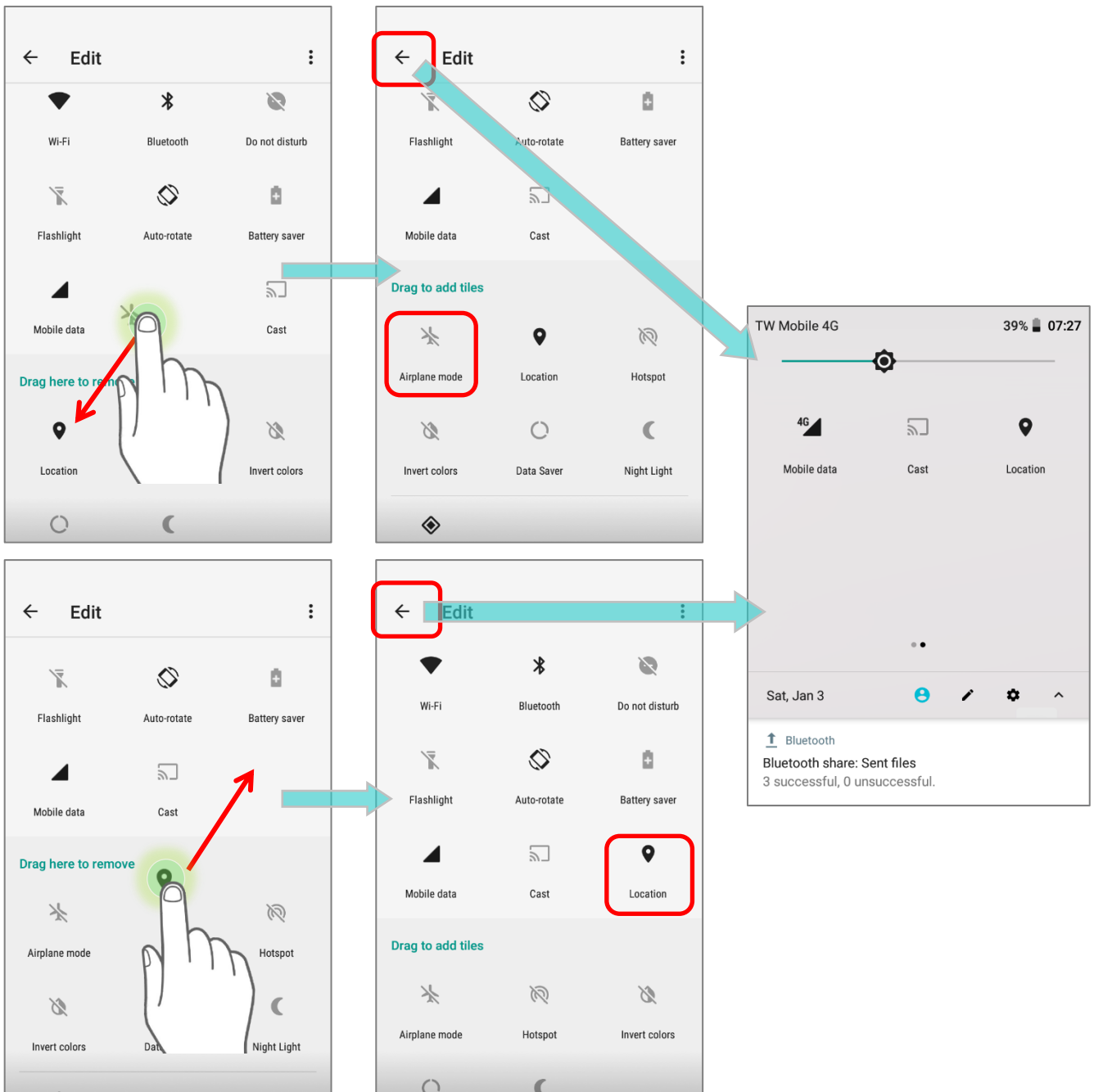
- 1) Click "**EDIT**" icon  to get into **Edit** page.
- 2) **Remove**: To remove certain item, please tap on and hold the icon to be removed, and drag it to the lower area and then release it.
- 3) **Add**: To add certain item, please tap on and hold the icon to be added and drag it to the upper area and then release it.
- 4) Return to the **Quick Settings menu**, all the settings are done.



To reset **Quick Settings Menu**, please:

- 1) Tap  to enter **Edit** page.
- 2) Tap **More**  icon in the upper-right corner, and tap "**Reset**".

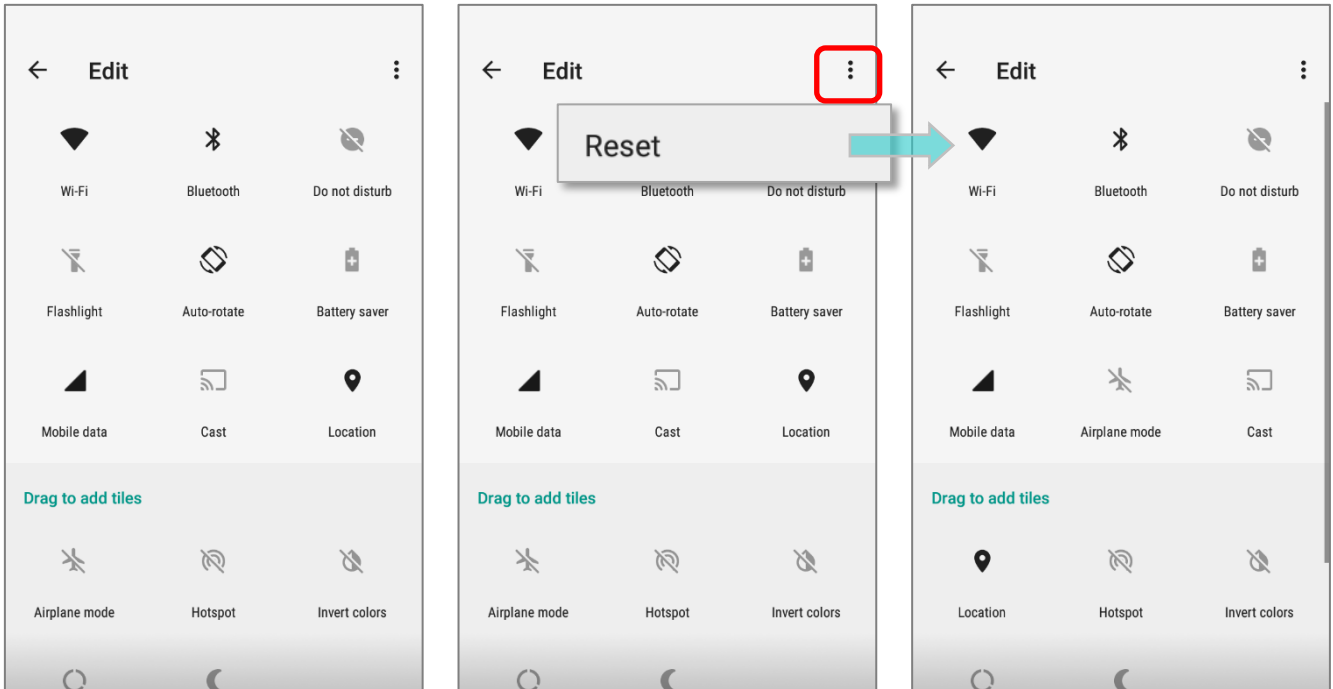

### 3.2.3. OPEN NOTIFICATIONS DRAWER

The **notifications icons** on status bar inform you of the new events such as incoming calls, messages or USB connection.

#### CHECK OUT NOTIFICATION

To check out details of the events, swipe down from the status bar to open [Notifications Drawer](#).

Tap on the individual notification card to carry out immediate action or to open the corresponding application.

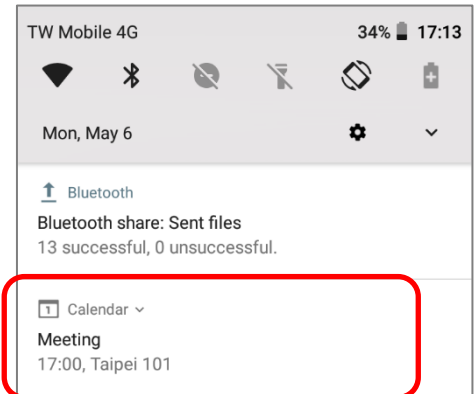

#### DISABLE NOTIFICATION

You can change or turn off the notification of a specific app by tapping and holding on the notifications card until the corresponding app name reveals. Tap **"MORE SETTINGS"** to modify the notification-related setting.

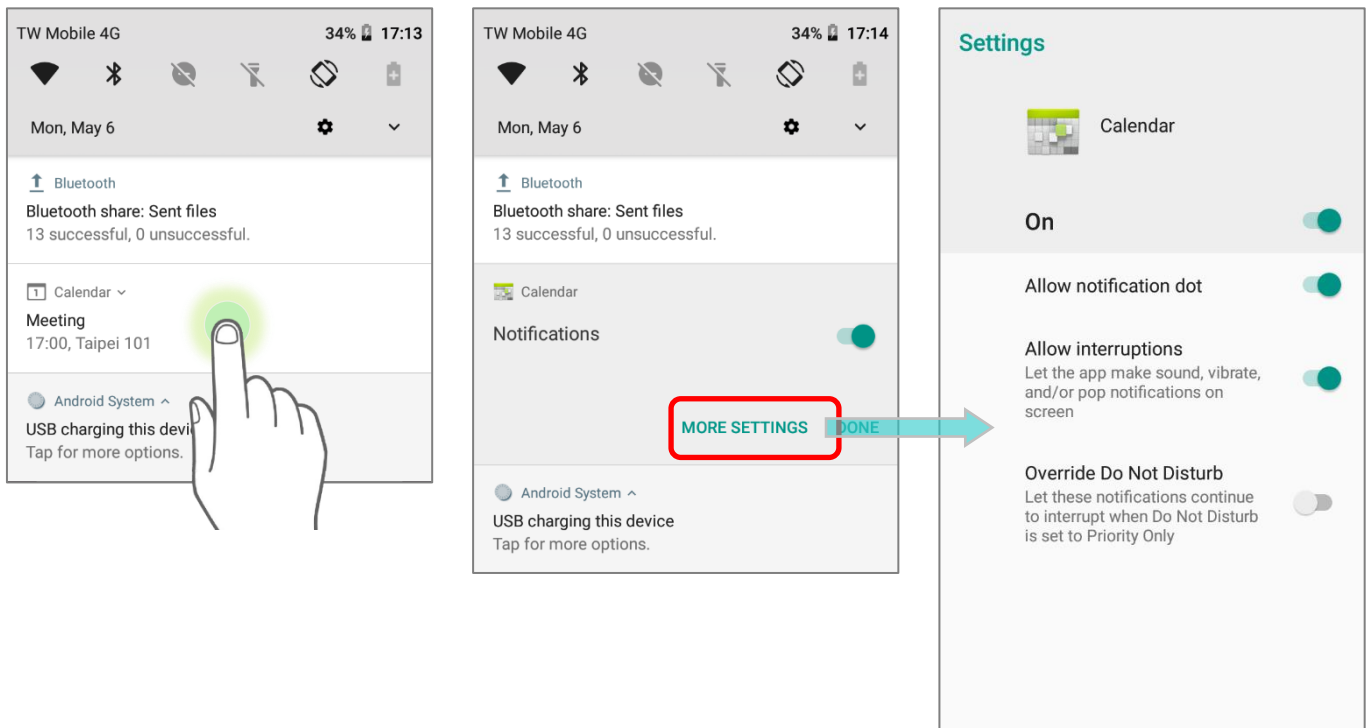

## SNOOZE NOTIFICATION

To temporarily dismiss the notification, you may snooze the notification by sliding it to the right or the left slightly and slowly till the reschedule icon ⌚ and the settings icon ⚙️ show up. Tap on the reschedule icon ⌚ to set the reminder while tapping on the settings icon ⚙️ for more settings.

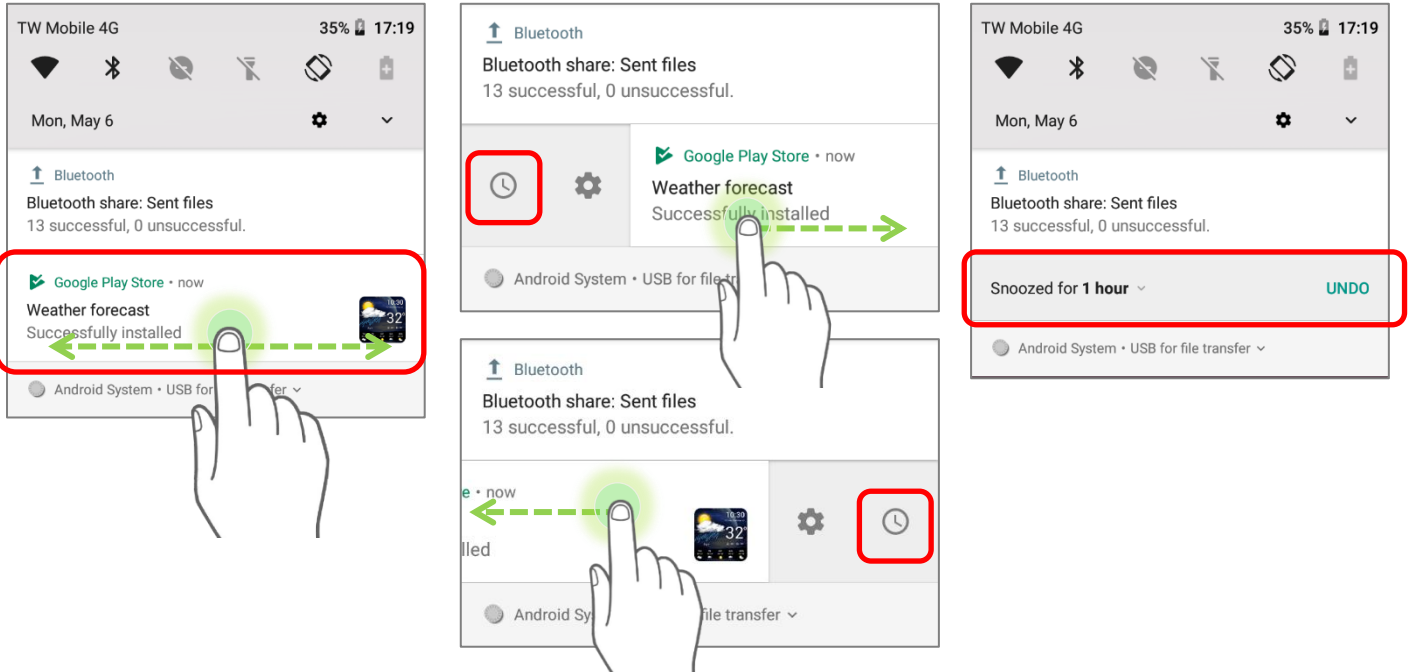

The default snooze time is one hour. Tap the time on the snooze menu for more time options:

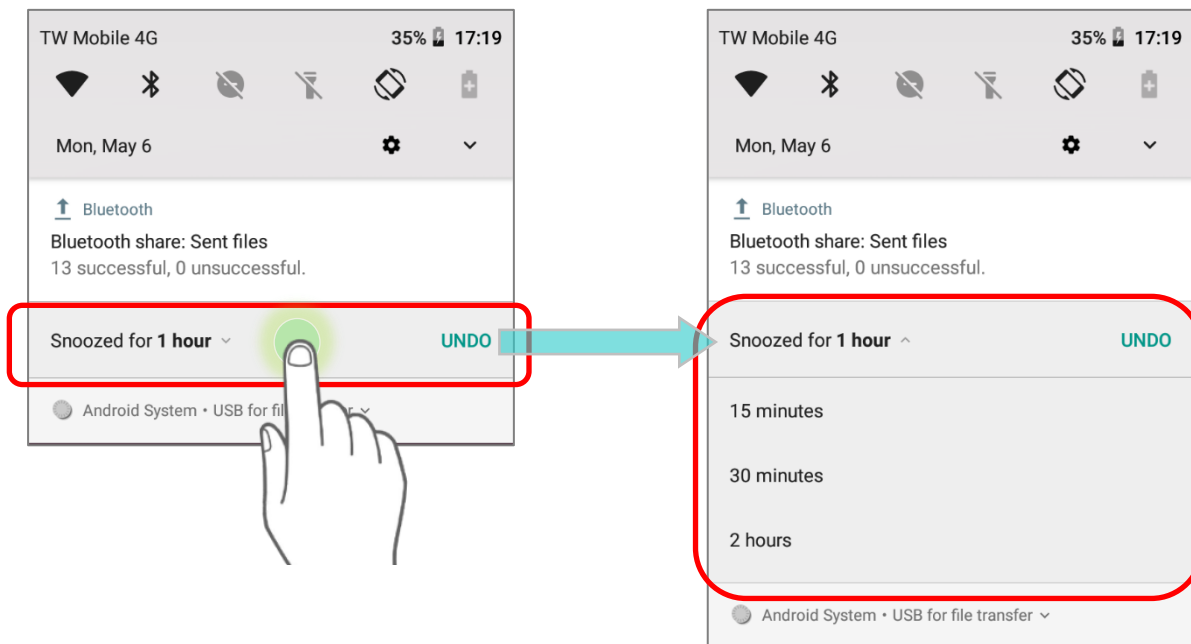

## CLEAR NOTIFICATION



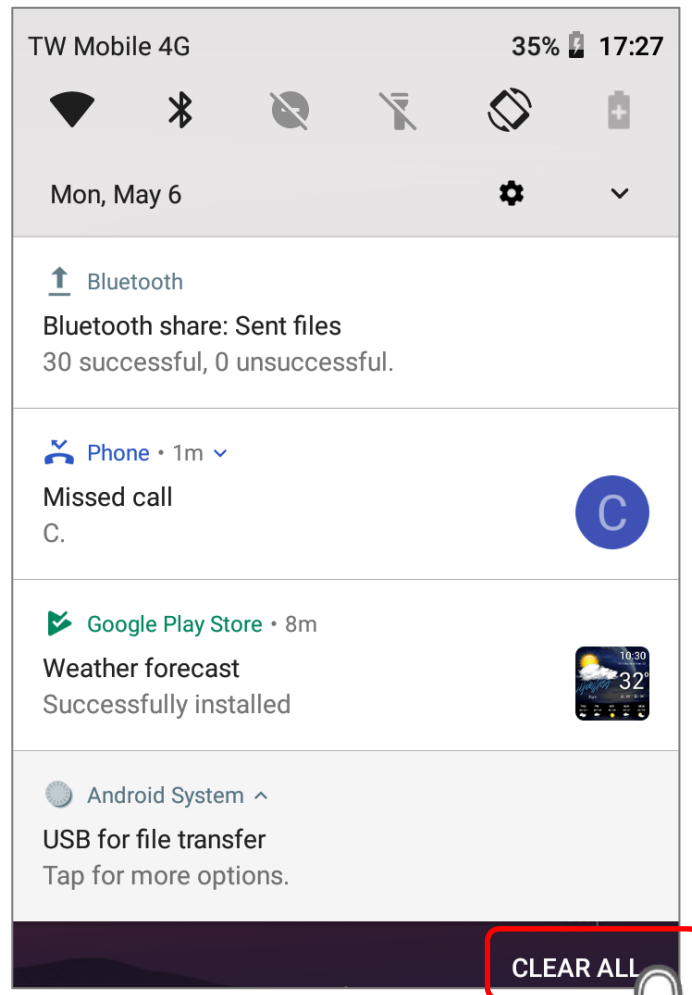









To dismiss a single notification, simply swipe the notification right or left. You can also dismiss all notifications at a time by tapping "**CLEAR ALL**". Ongoing notifications and notifications that require subsequent activity to be cleared will remain on the list.



















### 3.3. MANAGE APPLICATIONS

#### 3.3.1. APPLICATION MENU

Go to [App Drawer \(All Apps\)](#) to check the applications menu.

Icon	Name	Description
	A-Demo	An application which give the brief introduction about CipherLab's applications. Users can launch those apps by tapping " <b>START</b> " on the app's introduction page.
	Airlock Browser	Airlock Browser is a modern, feature rich, highly configurable web browser that allows mobile workers to be more productive.
	AppLock	An application used to limit the system resources made available to Users
	BarcodeToSetting	To help users to easily configure all the devices by exporting and generating the configurations as barcodes to be scanned by the devices to apply the configurations
	BT Printer Mate	An application which provides user interface to pair with Bluetooth printer.
	Calculator	Performs mathematical calculations.
	Calendar	Creates and manages events, meetings and appointments.
	Camera	Takes pictures and shoots videos.
	Chrome	An Android built-in browser application developed by Google.
	Clock	Sets date, time, time zone according to your locale, and sets and manages alarms.
	Contacts	Manages contact information, and shares or exports/imports the information to other devices or SD card.
	Drive	An Android built-in application for a file storage and synchronization service created by Google.
	Duo	A one-to-one video call application developed by Google.

---

	File Manager	Browses and manages files on the local storage and storage card.
	Files	List all files downloaded on the mobile computer.
	Gmail	An Android built-in application for Gmail, a free email service provided by Google.
	Google	An Android built-in application providing you easy access to handy services provided by Google such as searching for nearby restaurants or updates on traffic alerts.
	HF RFID Configuration	A NFC application which is for reading and writing NFC tags and RFID compatible chips.
	Maps	An Android built-in app developed by Google.
	Messages	Sends SMS and MMS messages.
	Messaging	Sends SMS and MMS messages.
	Music	An Android built-in music player application.
	Phone	Places and receives calls, accesses voicemail, views call history, manages phone contacts and adjusts phone settings.
	Photos	An Android built-in application for a photo and video sharing and storage service developed by Google.
	Play Movies & TV	An Android built-in application for an online video on demand service operated by Google.
	Play Music	An Android built-in application for a music streaming service and online music locker operated by Google.
	Play Store	An Android built-in application providing access to a digital distribution service, including a digital media store, the <b>Google Play Store</b> , operated and developed by Google.
	ReaderConfig	Sets scanner preferences, data output format and destination, symbology settings, and reads barcodes.
	Settings	Opens settings to configure the mobile computer.

---



Signature Capture

A simple and easy application which transform your device into a signature pad for user to draw the signature.



SoftwareTrigger

An application serving as a real trigger key, floating on top of all other programs for convenient trigger control of the barcode scanner.



Video

An Android built-in application which list all the videos saved in SD card and internal storage.



WMDSInstaller

The app to install WMDS (Wireless Mobile Deployment System) for Android. WMDS is a windows-based server program that can deploy the configuration projects (created by Android Deployment Configurator) to Android devices through wireless network.



YouTube™

An Android built-in application for a video-sharing service.

---

**Note:**

**Some applications such as “Phone” and “Messenger” are not available for Wi-Fi only model.**

---



### 3.3.2. CURRENT APPLICATIONS

Tap the **Recent Apps** button . The screen will show a list of recently used applications.

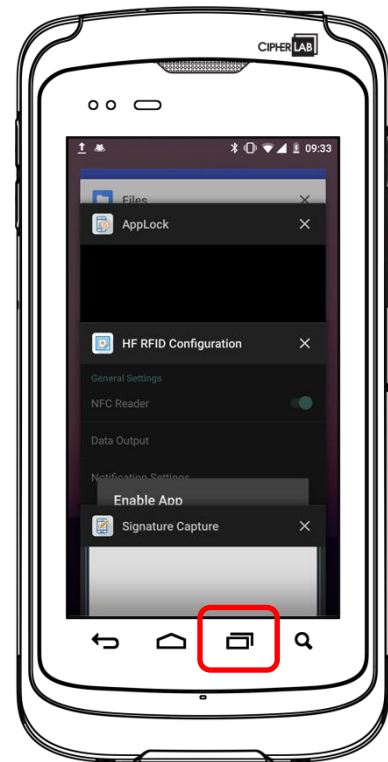

On this screen, you can:

#### SWITCH BETWEEN APPLICATIONS

Swipe up or down to cycle through the listed applications; tap on your desired one to open it on the screen.

#### END APPLICATION

Slide an application to the left or right, or tap the **X** on top right to close it.

#### Note:

Close unused applications to release RAM space. Remember to save your data or settings before closing any application.

### 3.4. SUSPEND & LOCK

#### 3.4.1. SUSPEND DEVICE

The mobile computer operates continuously once it is powered on. To minimize power consumption and prevent unintended operation, suspend the mobile computer if you are not actively using it. The mobile computer can be quickly awoken from suspend mode to operate as needed. When the mobile computer enters suspend mode, the system is in a power-saving status, meaning the device will not respond to screen touch, and volume keys and side buttons will also be unavailable until the device is unlocked.

#### SUSPEND RS51

Press the power button to immediately suspend the mobile computer. The mobile computer will also automatically get into suspend when the time interval set in [Screen Timeout Settings](#) has passed without any activity.

**Warning:** To save battery power, suspend the mobile computer when not in use.

#### 3.4.2. LOCK DEVICE

Setting a screen lock allows you to protect your personal data on this device while the device is not at your hand. With various types of screen lock available and Smart Lock, you can not only enjoy the benefits of this function but also great convenience.

#### LOCK RS51

Tap [App Drawer \(All Apps\)](#) | **Settings**  | **Security & Location**  | **Device security** to change the lock method.

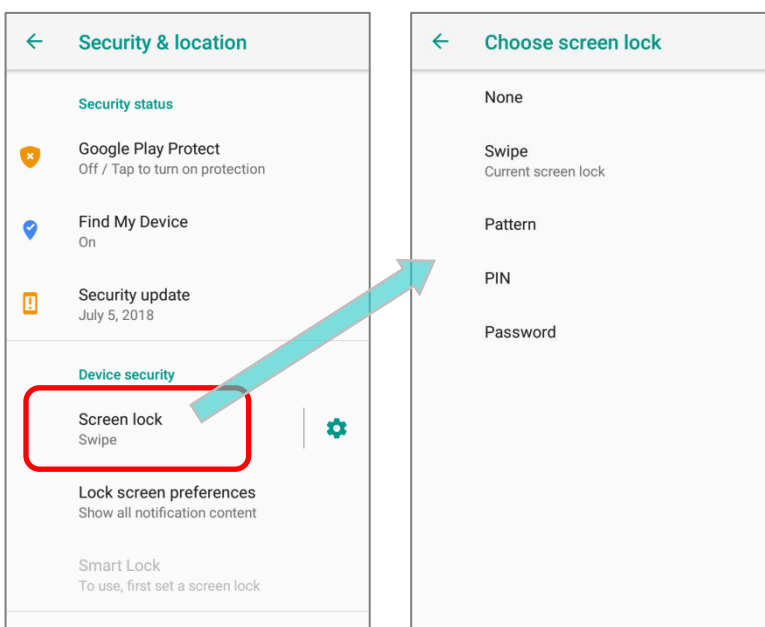

Item	Description
<b>None</b>	Disable screen lock.
<b>Swipe</b>	Default slide gesture.
<b>Pattern</b>	Enter a pattern to unlock.
<b>PIN</b>	Uses the PIN code to unlock.
<b>Password</b>	Enter a password of at least 4 characters to unlock.

By selecting a **pattern**, **PIN**, or **Password** method, you can access advanced settings and **Smart Lock** to customize personal lock settings.

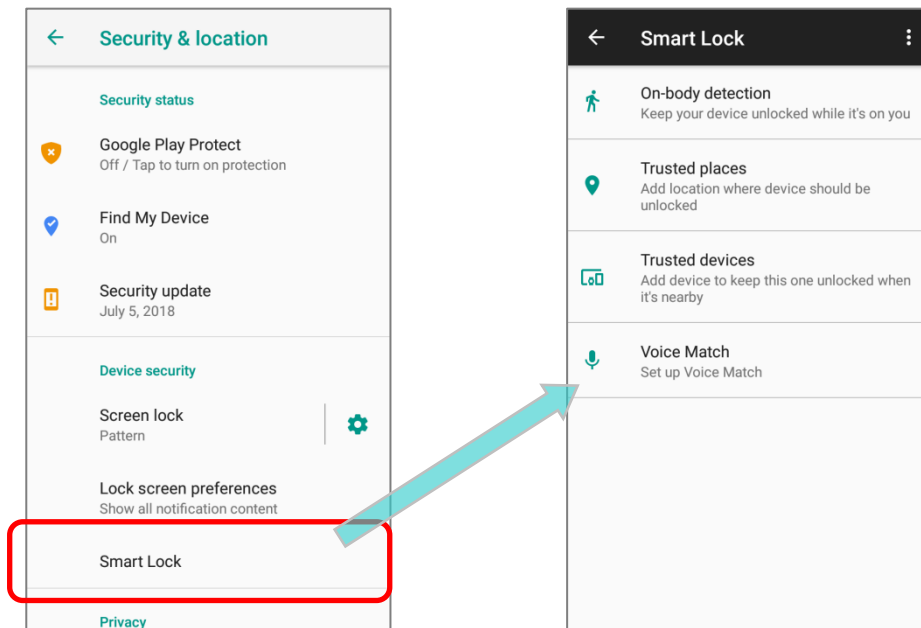

## SCREEN LOCK SETTINGS

Except of setting **“None”** for screen lock, you can tap on the settings icon  next to **“Screen lock”** for further settings:

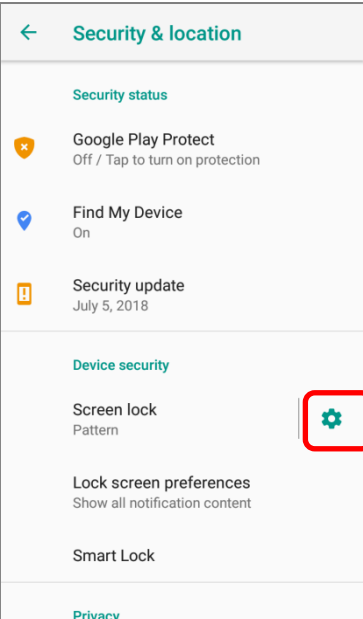

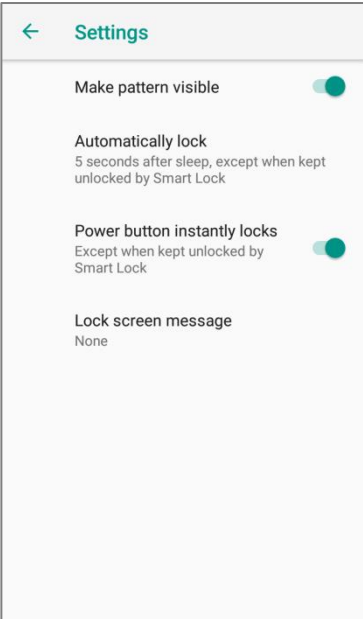

Item	Description
<b>Make pattern visible</b>	Switch to make the unlock pattern you are drawing to be visible or invisible. This function only works when setting pattern as screenlock.
<b>Automatically lock</b>	Tap to set the time interval to automatically lock the screen after screen timeout.
<b>Power button instantly lock</b>	Switch to enable/ disable instantly lock screen by pressing power button.
<b>Lock screen message</b>	Set the message to be shown on the lock screen.

### 3.5. OS UPDATE

Updating the operating system on the mobile computer helps maintain it at an optimized state. You may choose to update the system by establishing a wireless network connection to the Internet and downloading the update file from the OTA server.

**Note:**





The mobile computer will shut down during system update. Save any unfinished tasks and data before updating the system in order to avoid data loss.

#### NETWORK UPDATE

In order to check for and download the latest system update file on the server, make sure a wireless network connection to the Internet is established on the mobile computer.

**Note:**

To avoid any additional charges to your wireless data plan, the Wi-Fi connection to the Internet is recommended for downloading the file.

- 1) Go to [App Drawer \(All Apps\)](#) | [Settings](#)  | [System](#)  | [About phone](#)  | [System updates](#) . A dialog pops up asking you to input the password for system update. Please contact with [support@cipherlab.com.tw](mailto:support@cipherlab.com.tw) for the password. Enter the password and tap **OK**.

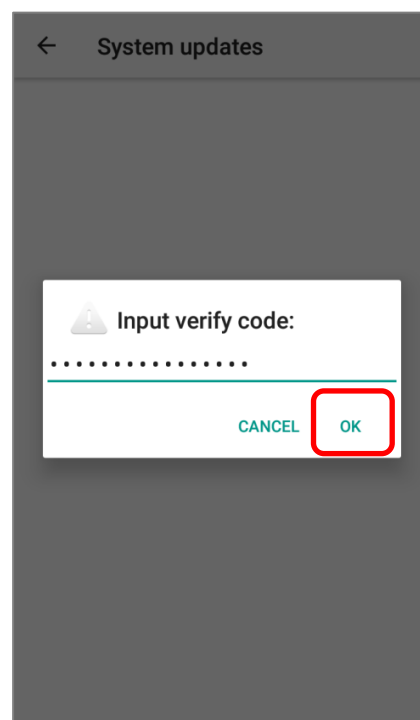
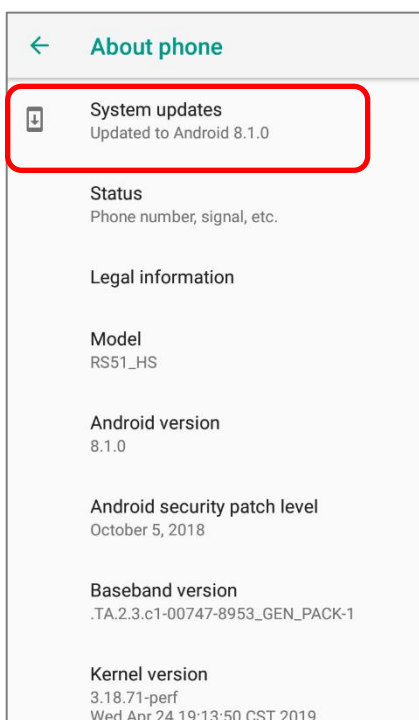

- 2) The mobile computer searches for the latest system update file on the server. Tap **DOWNLOAD AND INSTALL** to download the update file.
- 3) When a new system update file is detected on the server, a notification icon will appear on the status bar, and a text notification will pop up in the notifications panel.

---





## SD CARD UPDATE

OS Update searches for available update files in your mobile computer's storage.

- 1) Obtain the latest system update image file, and copy the file onto the root storage of your SD card. Insert the SD card into the memory card slot on the device. Press the power button to power it on.

**OR**

Transfer the update image file to the root directory of the device's internal storage via USB cable.

- 2) Go to [App Drawer \(All Apps\)](#) | **Settings**  | **System**  | **About phone**  | **System updates** .
- 3) A window pops up asking you to input the password for system update. Please contact with [support@cipherlab.com.tw](mailto:support@cipherlab.com.tw) for the password. Enter the password and tap **OK**.
- 4) The mobile computer searches for an available system update file on the SD card.

---

### Note:

Make sure the SD card is inserted in the mobile computer. If not, the screen will show that your system is currently up to date.

---

- 5) Tap **INSTALL** to open an "**Install update**" confirmation dialog. Tap **Install** in the confirmation dialog to begin the installation.

Once complete, a notification will appear showing that the system has been updated successfully. Tap **OK** to show the Home screen.

### 3.6. BACK UP YOUR DATA

With **Backup**, you can have your personal data (Apps & apps data, call history, contacts, and SMS) and certain system settings under your Google account backed up (over network connection) on the cloud. This allows you to easily restore the settings on this device after a Factory Reset (refer to [Reset to Factory Default](#) ).

To start:

- 1) Make sure your device is connected with network.
- 2) Tap **App Drawer (All Apps)** | **Settings**  | **System**  | **Backup**  and enable Back up to Google™ Drive.

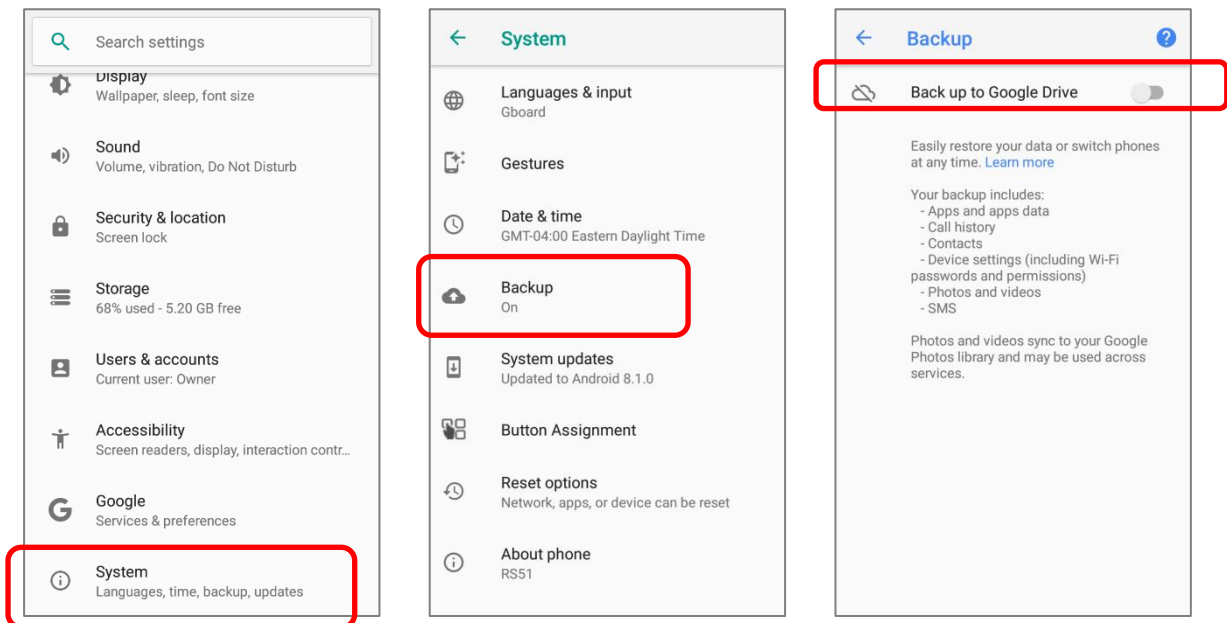

- 3) Tap **Account** to log in to your Google account.

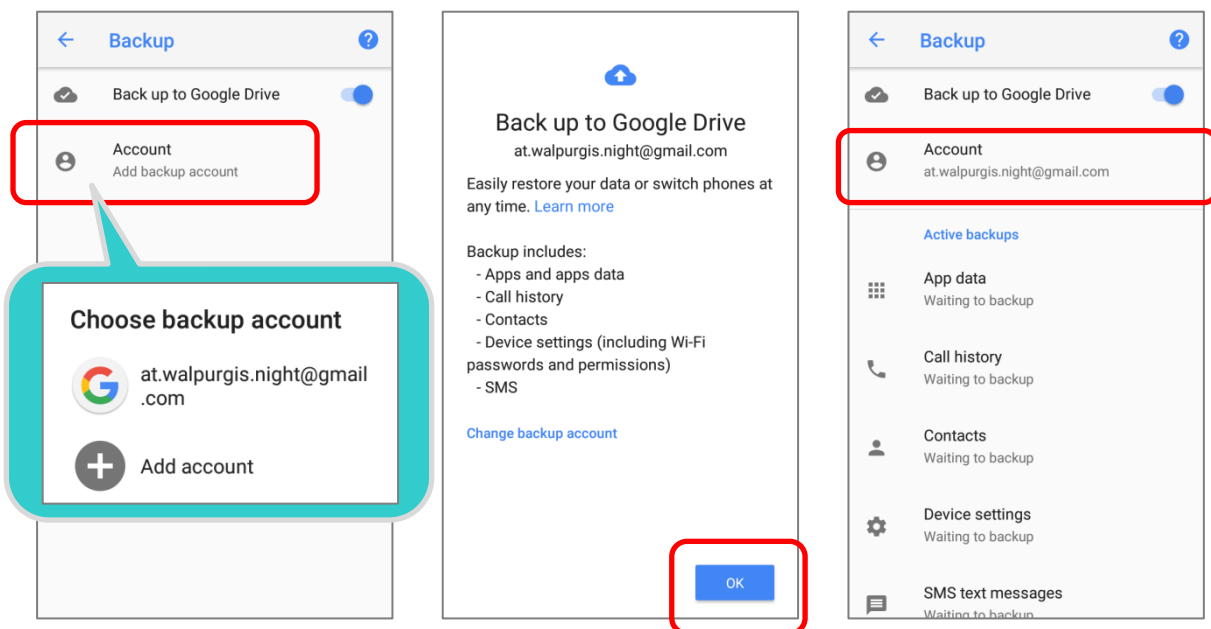

To restore the backed up personal data of a Google Account, just add that account to the device.

**Note:**

- (1) To back up your photos and videos, tap [App Drawer \(All Apps\)](#) | [Photos](#)  and log in your Google account to sync the files on your device with Google Photo Library.

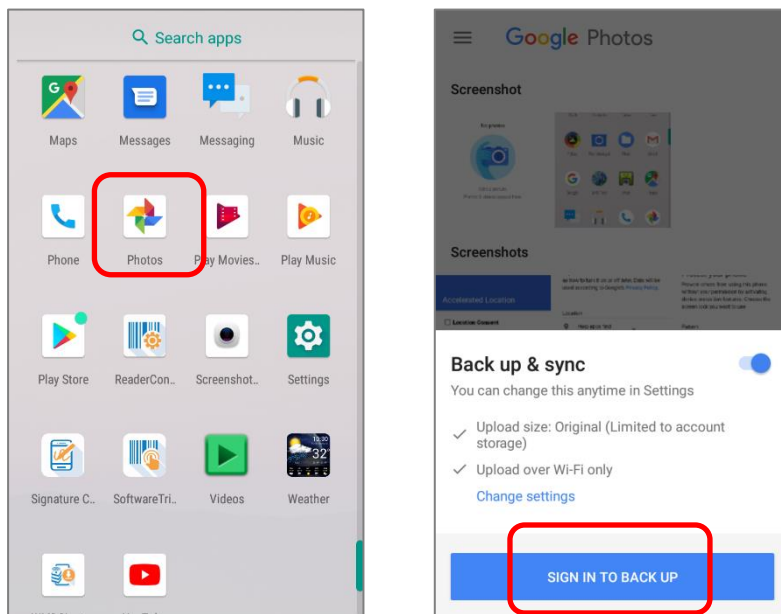

- (2) To back up other data such as audio or video files on the device's storage, you can make use of the Google Drive service.

- (3) Backup may not handle certain app progress data and settings.

### 3.7. RESET TO FACTORY DEFAULT

Performing a factory reset will erase all data on your mobile computer (including call logs, messages, files as well as your installed apps and their associated data) and revert the device back to its original state in which it is powered on for the first time.

It is strongly recommended that following the instructions in [Back up Your Data](#) to back up important data before performing a factory reset.

When setting your RS51 mobile computer by **ADC** (Android Deployment Configurator), the settings will automatically backup to "**enterprise partition**" of your RS51 mobile computer, and the settings saved in enterprise partition will not be erased by proceeding "**Erase all data (factory reset)**". To erase all the settings, please select "[Erase all data \(factory reset with enterprise\)](#)".

#### 3.7.1. ERASE ALL DATA (FACTORY RESET)

"**Erase all data (factory reset)**" will erase all the data except of the settings backed up in enterprise partition by ADC (Android Deployment Configurator).

To start:

- 1) Go to [App Drawer \(All Apps\)](#) | **Settings**  | **System**  | **Reset option**  | **Erase all data (factory reset)**

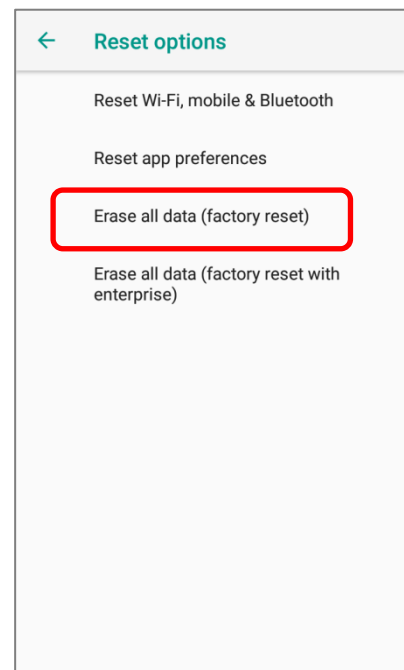
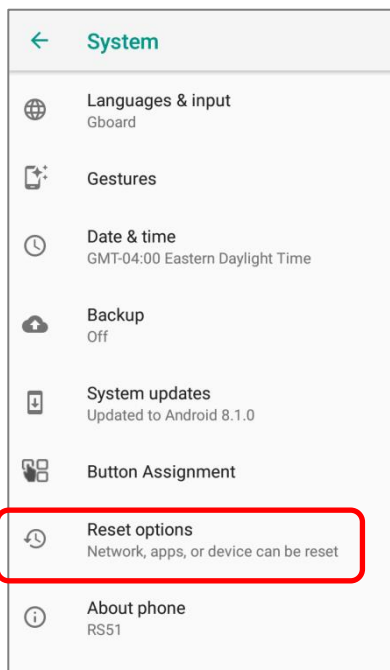
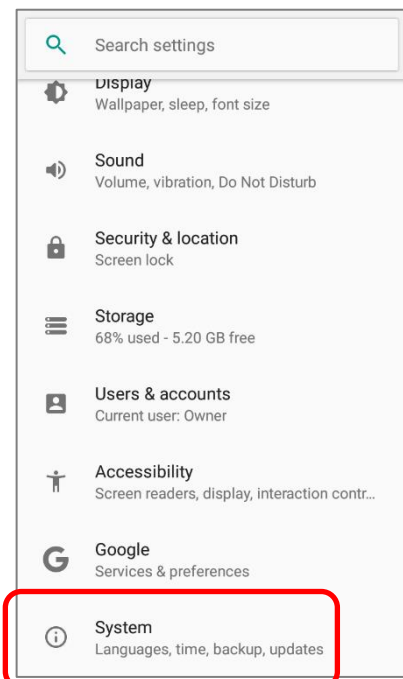



- 2) Confirm the action by tapping on the buttons and input the verification code (Please contact with [support@cipherlab.com.tw](mailto:support@cipherlab.com.tw) to obtain your verification code). Finally, tap **OK** to perform a factory reset.

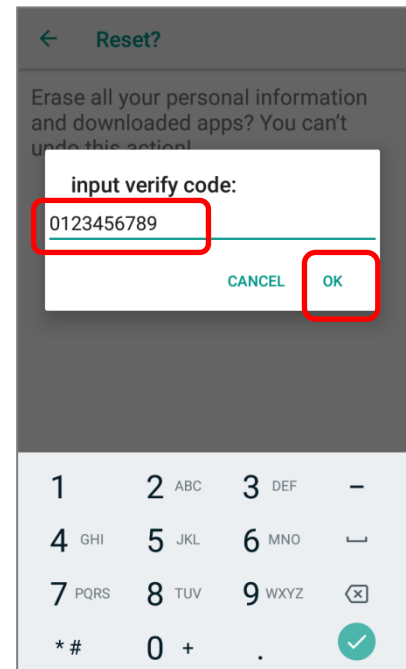
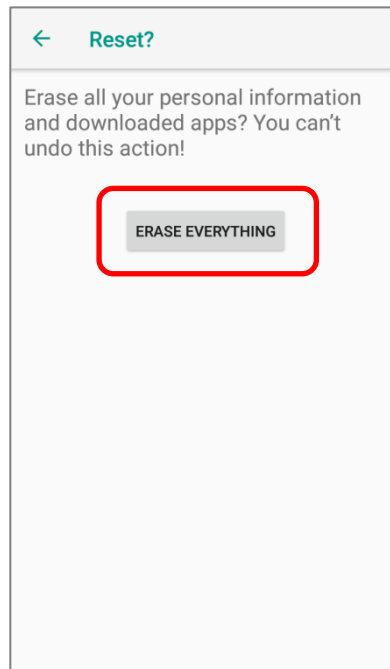
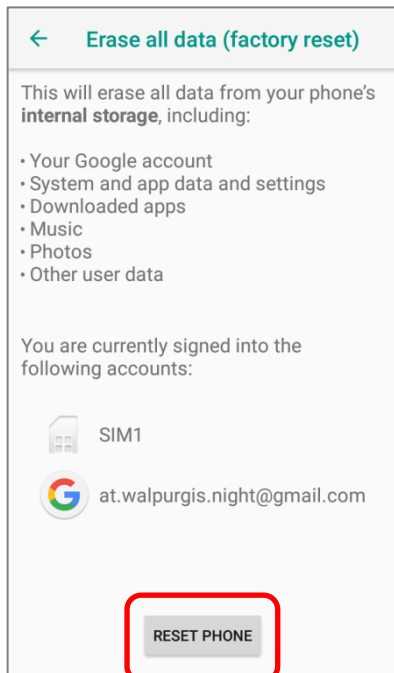

### 3.7.2. ERASE ALL DATA (FACTORY RESET WITH ENTERPRISE)

Go to [App Drawer \(All Apps\)](#) | **Settings**  | **System**  | **Reset option**  | **Erase all data (factory reset with enterprise)**

Confirm the action by tapping on the buttons and input the verification code (Please contact with [support@cipherlab.com.tw](mailto:support@cipherlab.com.tw) to obtain your verification code), and tap **OK** to perform a factory reset.

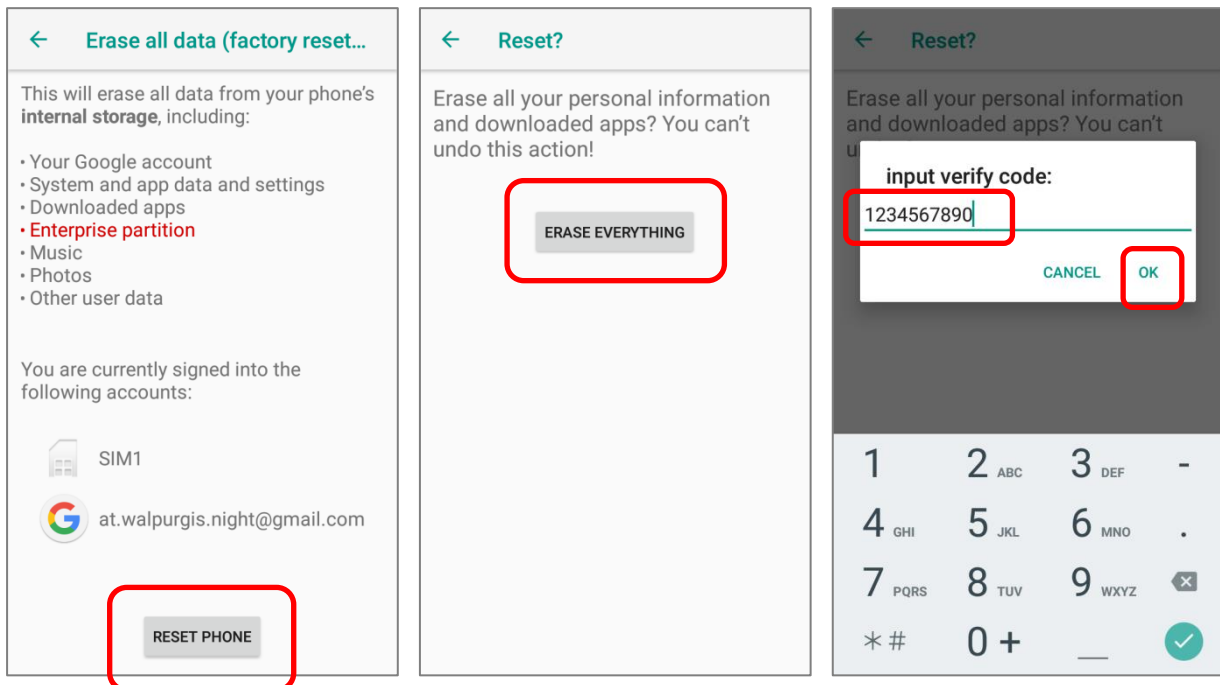

Please note that "**Erase all data (factory reset with enterprise)**" will erase all the data including the settings backed up in enterprise partition by **ADC (Android Deployment Configurator)**.

### 3.7.3. WELCOME WIZARD

As the mobile computer boots up for the first time after the reset, the Welcome wizard will run you through setting up the environment as well as restoring apps and data. During setup, you can tap **SKIP** to continue to the next step (you can finish the respective settings in [App Drawer \(All Apps\)](#) | **Settings**  at any time). Please note that to have the backed up data in your Google accounts restored right in this stage, log in to a Wi-Fi network when prompted to **Select Wi-Fi Network**.

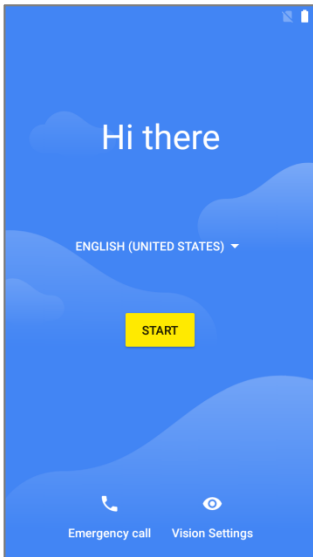

Step 1-1:  
Tap on “**STARTED**” to proceed, or tap to enter “**Choose your language**” page/ “**Vision Settings**” page.

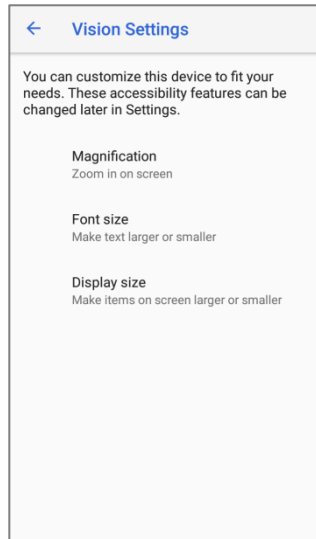

Step 1-2:  
Customize your device if needed.

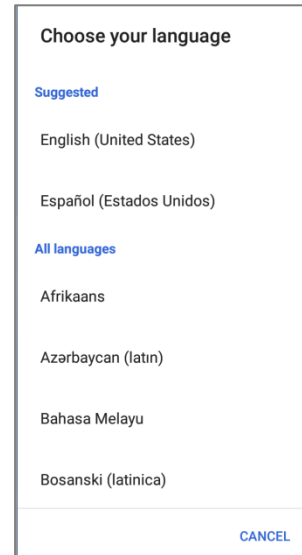

Step 1-3:  
Select your system language.

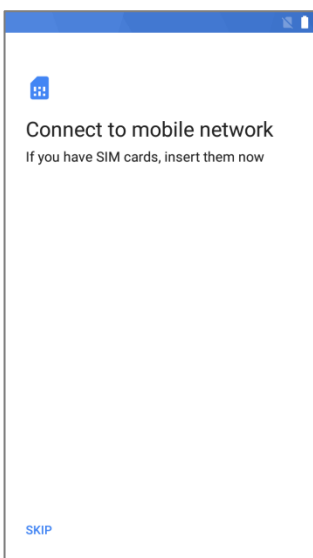

Step 2:  
Insert your SIM to connect to mobile network, or tap on “**SKIP**” to the next step.

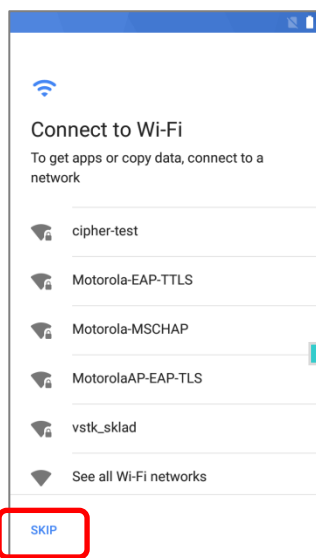

Step 3:  
Select a Wi-Fi network to log in or tap on “**SKIP**” to the next step. If logged in a Wi-Fi network, you will be further asked to sign in your Google account to restore data.

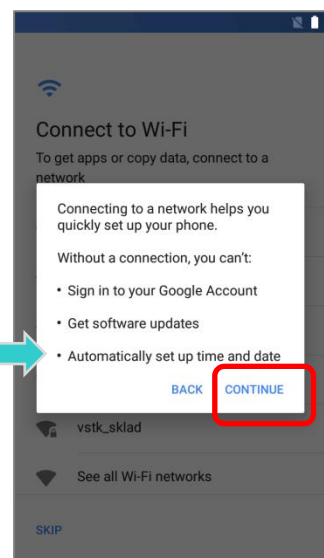

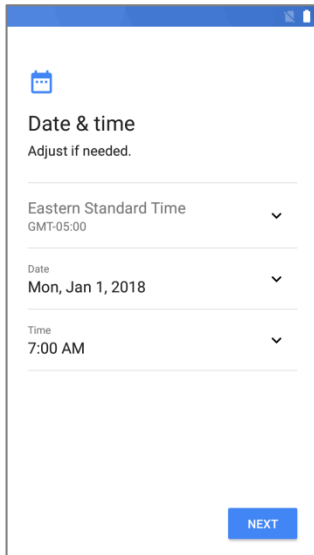

Step 4:  
Set date and time, or merely skip this step by tapping “NEXT”

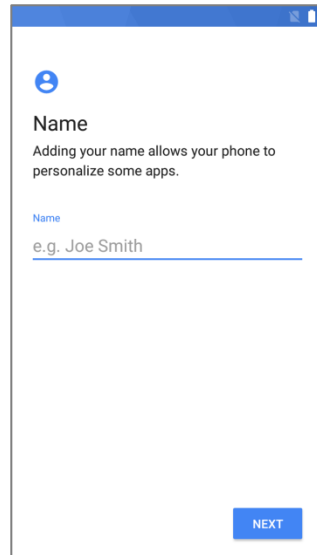

Step 5:  
Input your name, or merely skip this step by tapping “NEXT”.

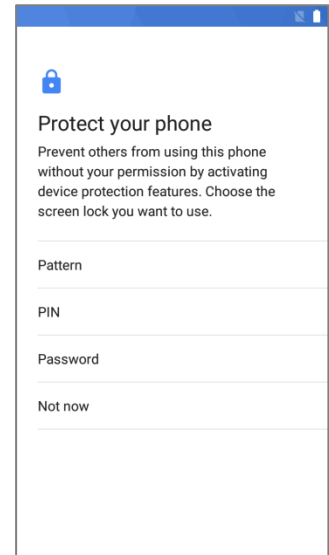

Step 6:  
Set up the protection methods to protect this device. Select “Not now” to skip.

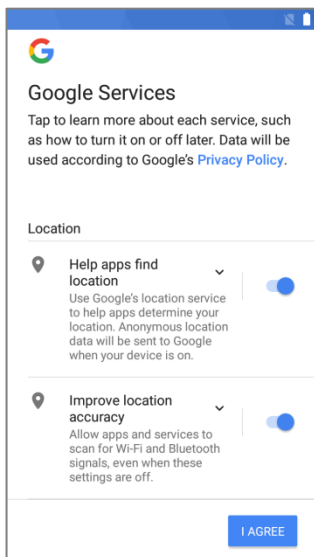

Step 7:  
Choose Google services that you want to be enabled, and tap “AGREE” to proceed.

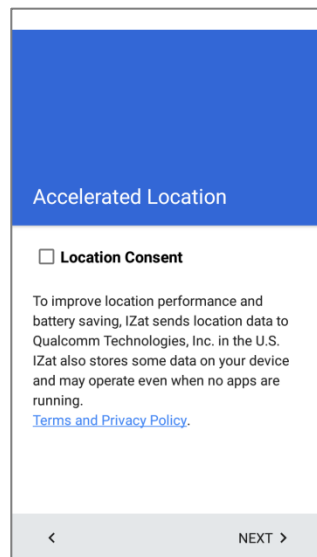

Step 8:  
Select whether to enable Qualcomm® IZat™ location service or not. Tap “NEXT” to proceed.

Once the initial setup is completed, the Home app screen shows up. Apps and settings will be restored in the background.

**Note:** “[Battery Swap](#)” is unavailable during Welcome Wizard.

# Chapter 4

## WIRELESS RADIOS

---

With the Wi-Fi module integrated on the mobile computer, you can configure and connect to network wirelessly.

### IN THIS CHAPTER



---

4.1 Use Wireless Wide Area Network.....	118
4.2 Use Wireless Local Area Network (Wi-Fi).....	133
4.3 Use Bluetooth.....	142
4.4 Use Near Field Communications.....	148

## 4.1. USE WIRELESS WIDE AREA NETWORK

The mobile computer will be automatically configured to connect to your wireless service provider's network when you insert a SIM card and turn on data connection for the first time.



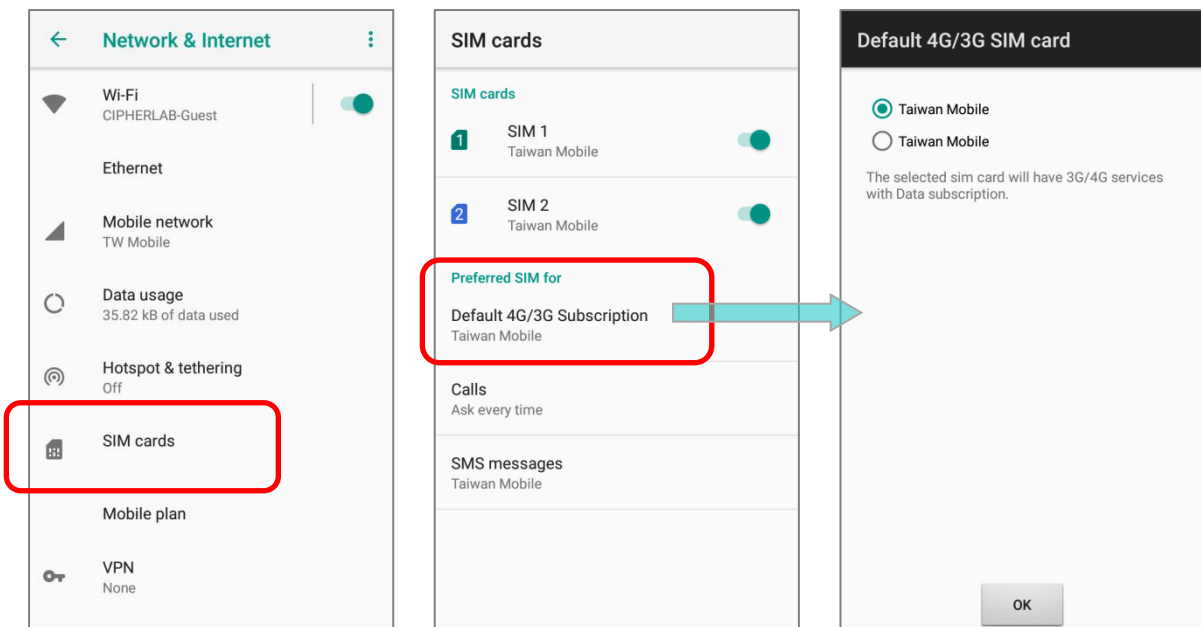
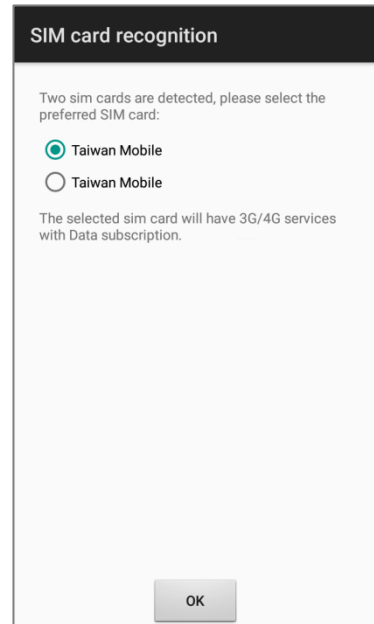

If dual SIM card is inserted, a confirmation page appears for user to select the preferred SIM card for 4G/3G subscription.

You can make change later in [App Drawer \(All Apps\)](#) | **Settings**  | **Network & Internet**  | **SIM cards**  | **Default 4G/3G Subscription:**



## EDIT ACCESS POINT NAME

You may need to change the access point name according to the information obtained from your mobile carrier.

- 1) Go to [App Drawer \(All Apps\)](#) | **Settings**  | **Network & Internet**  | **Mobile Network**  | **Access Point Names**.
- 2) Tap  on the action bar to enter "**Edit access point**" page and tap each field to input the **APN** name and settings obtained from your mobile carrier.
- 3) When finished, tap the more button on the action bar  and select **Save**.
- 4) Back to **APNs** page; tap the radio button next to the APN you would like to apply.

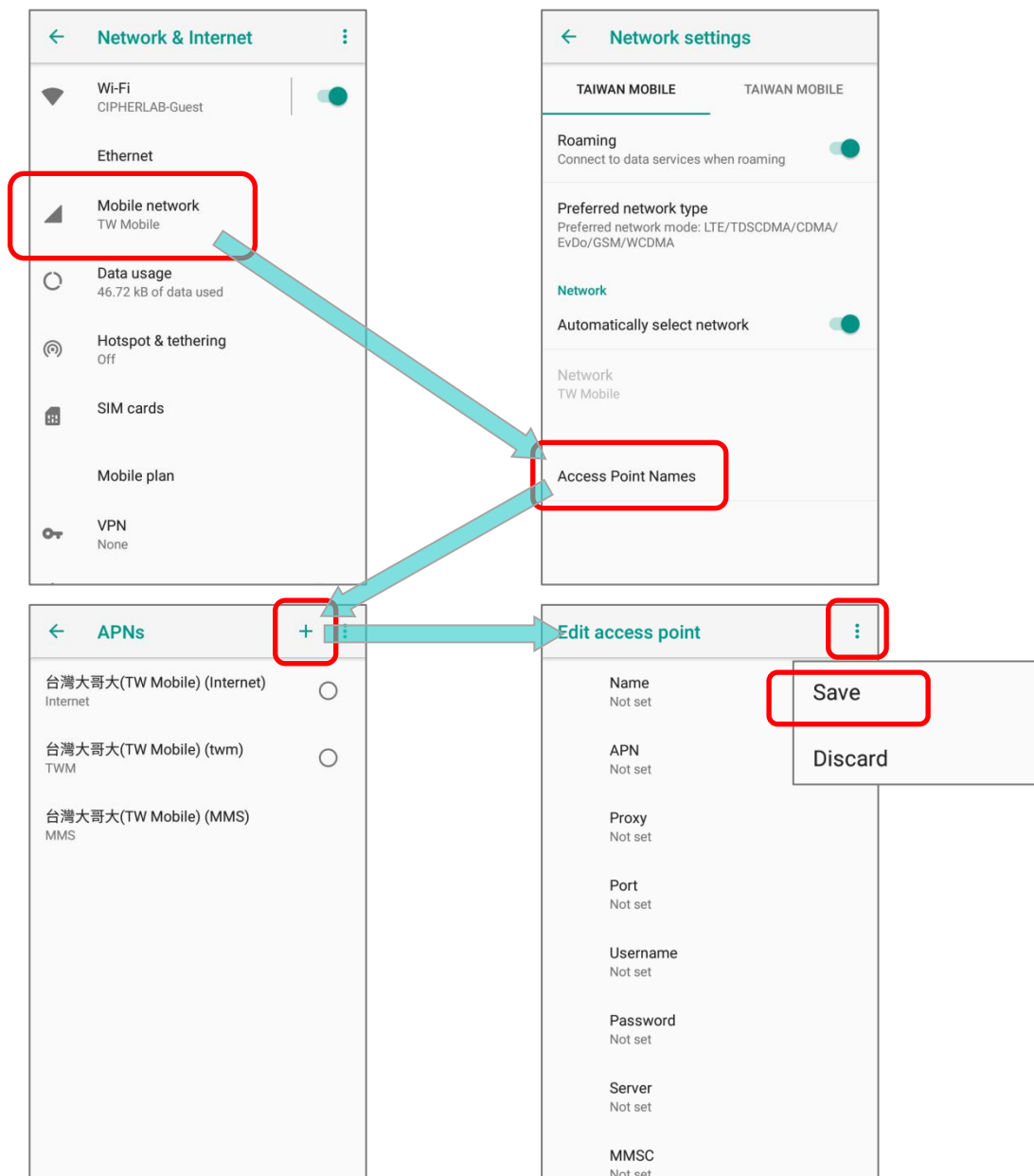





### 4.1.1. SHARE WWAN DATA

The WWAN connection on the mobile computer can be shared to other devices. You may share internet connection with a computer or device through USB or Bluetooth tethering, or share with a maximum of eight devices by turning the mobile computer into a Wi-Fi hotspot.

#### BLUETOOTH TETHERING

To share data connection through Bluetooth tethering:



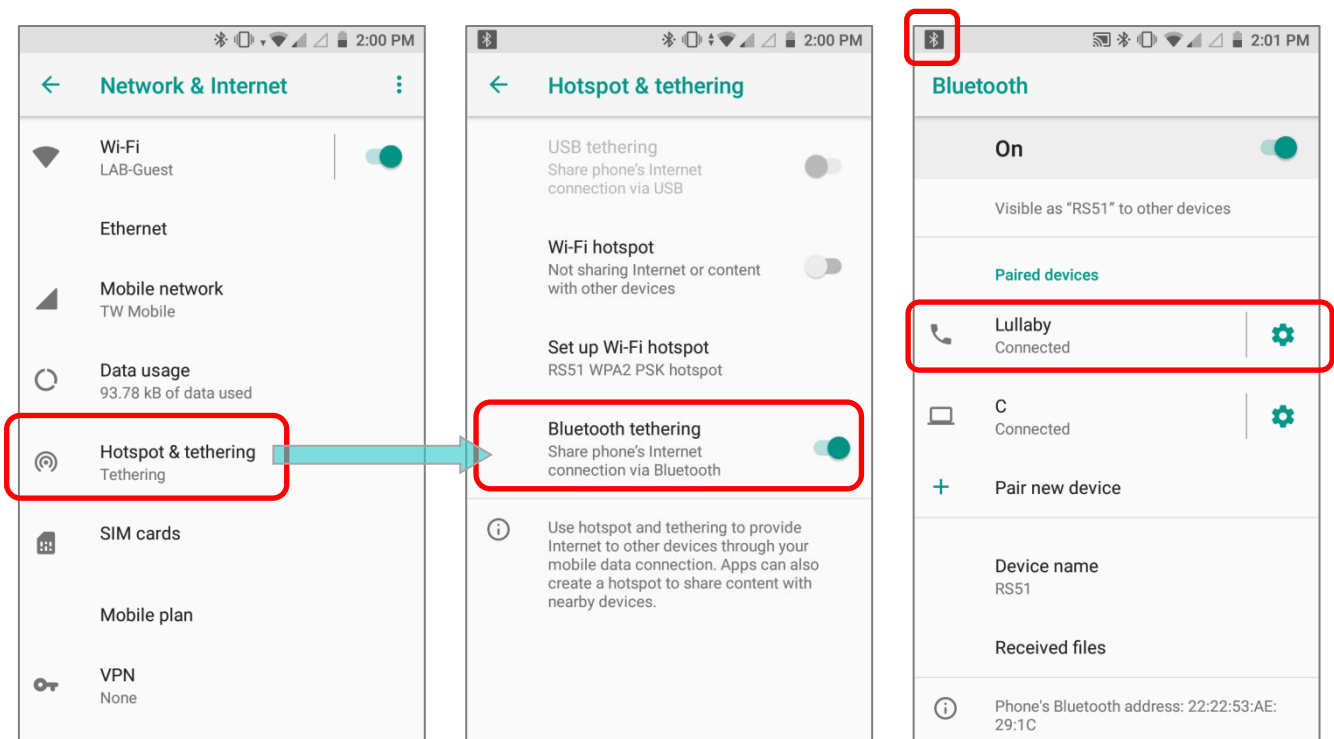

- 1) Pair the mobile computer with the device of interest.
- 2) Go to [App Drawer \(All Apps\)](#) | **Settings**  | **Network & Internet**  | **Hotspot & tethering** .
- 3) Tap to switch on **Bluetooth tethering**. The mobile computer will share its WWAN network with Bluetooth-connected devices through Bluetooth sharing. Once the sharing is successful, the icon  will appear on the top of the screen.





## USB TETHERING

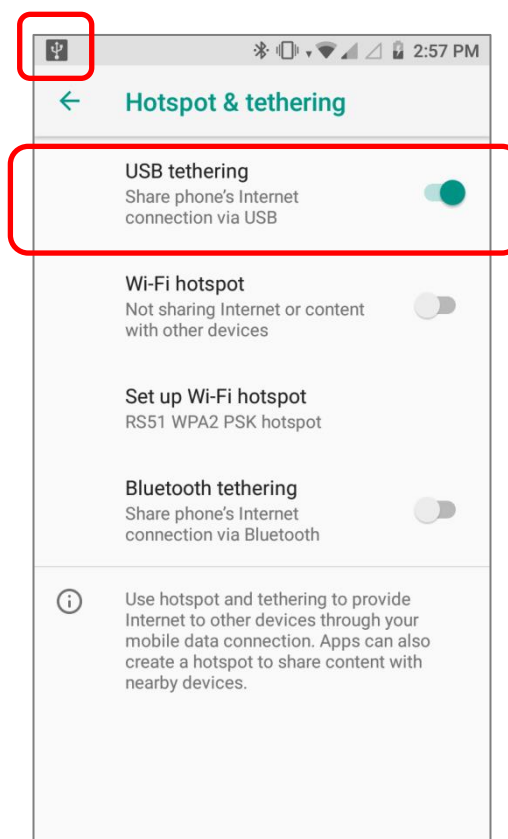

To share data connection through USB tethering:

- 1) Connect the mobile computer with PC by the supplied snap-on cable.
- 2) Go to [App Drawer \(All Apps\)](#) | **Settings**  | **Network & Internet**  | **Hotspot & tethering** .
- 3) Tap to switch on **USB tethering**, and the icon  shows up on the status bar. The mobile computer will share its WWAN network with the connected host computer.



## WI-FI HOTSPOT

To share data connection in the form of a Wi-Fi hotspot:

- 1) Go to [App Drawer \(All Apps\)](#) | **Settings**  | **Network & Internet**  | **Hotspot & tethering** .
- 2) Tap the **Wi-Fi hotspot** switch to enable data sharing through Wi-Fi. The mobile computer will start broadcasting its SSID for other devices to connect.

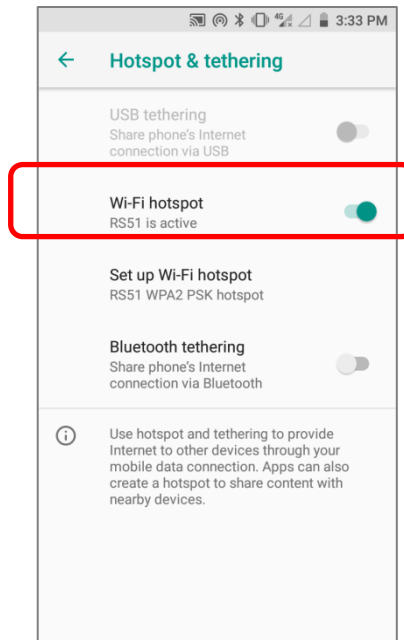

- 3) Tap **Set up Wi-Fi hotspot** to manage Wi-Fi hotspot settings.

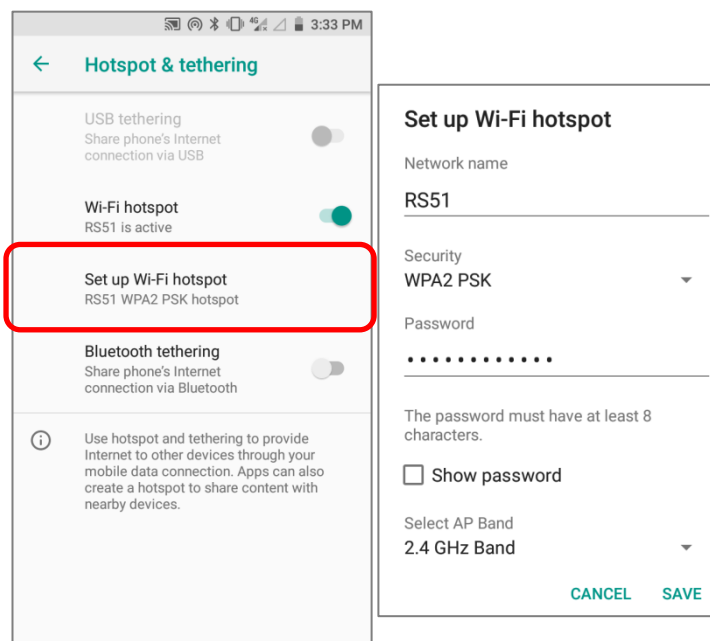

**DATA USAGE**

Data usage is the amount of data uploaded or downloaded on the mobile computer. Managing the data usage amount within a certain period of time is a recommended task, as an excess amount of data usage might incur additional fees from your service provider.

To check wireless data usage, please go to [App Drawer \(All Apps\)](#) | **Settings**  | **Network & Internet**  | **Data usage** .

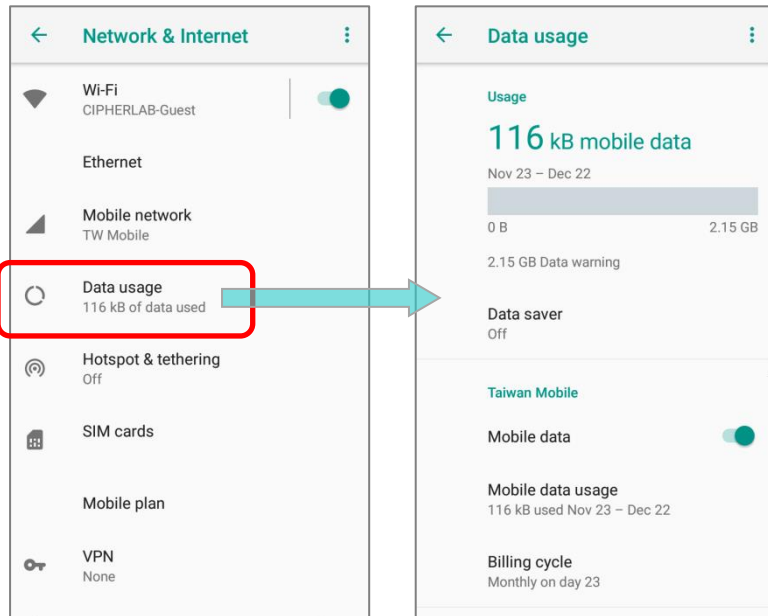

Scroll to the mobile network you are going to check for further settings:

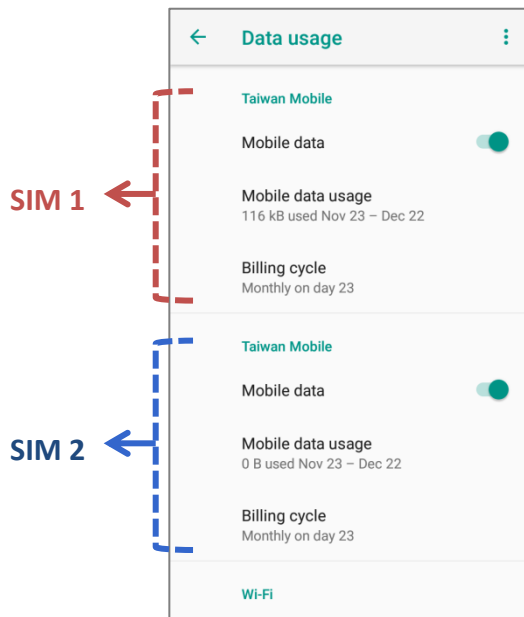

Item	Description
<b>Mobile data</b>	Switch on or off the mobile data.
<b>Mobile data usage</b>	Tap to view a chart of data usage
<b>Billing cycle</b>	Tap to set the billing cycle, data warning, and data limit.

## SET DATA USAGE LIMIT

To set the data usage limit, please:

- 1) Go to [App Drawer \(All Apps\)](#) | [Settings](#)  | [Network & Internet](#)  | [Data usage](#) . On the **Data usage** page, scroll to your mobile carrier and tap "**Billing cycle**".

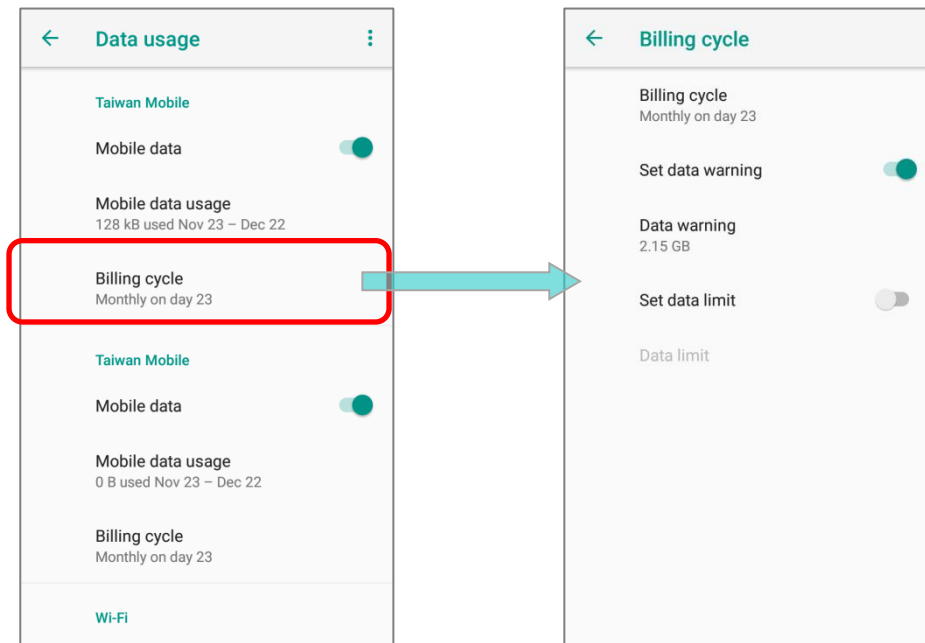

Or tap "**Mobile data usage**" and the setting button  to enter "**Billing cycle**" page.

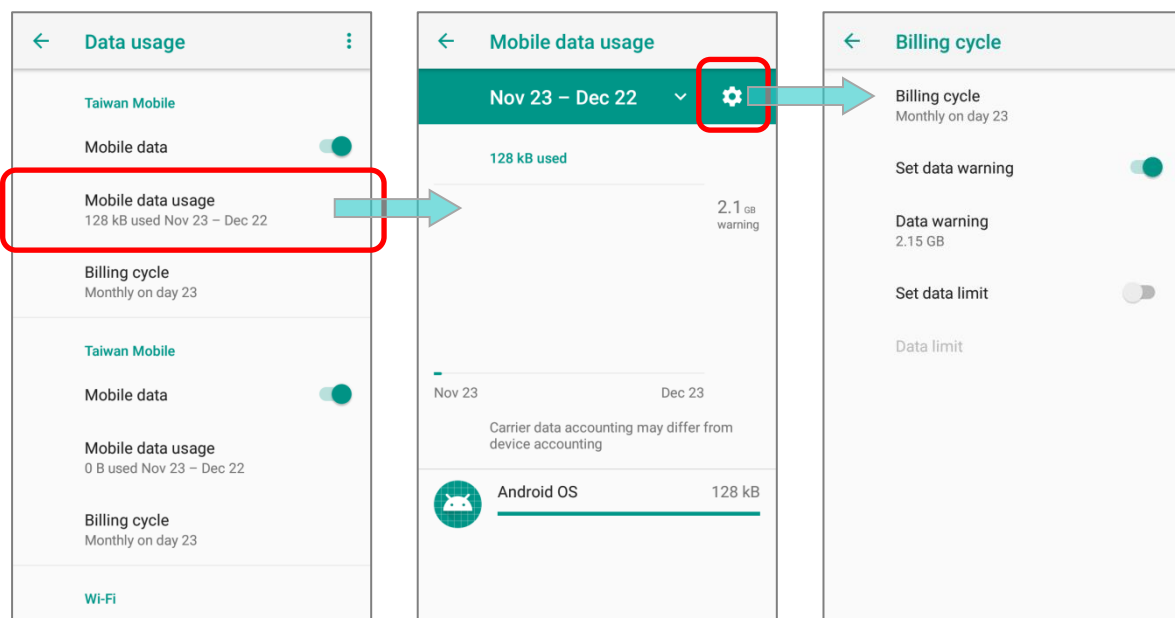

2) Enable **Set mobile data limit**.

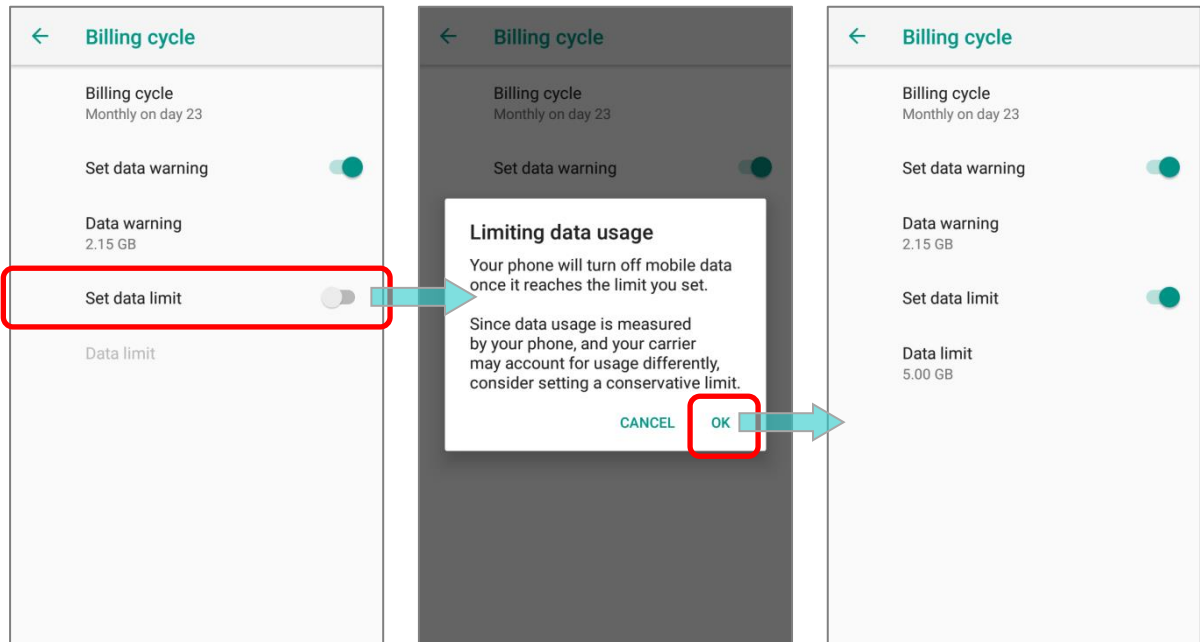



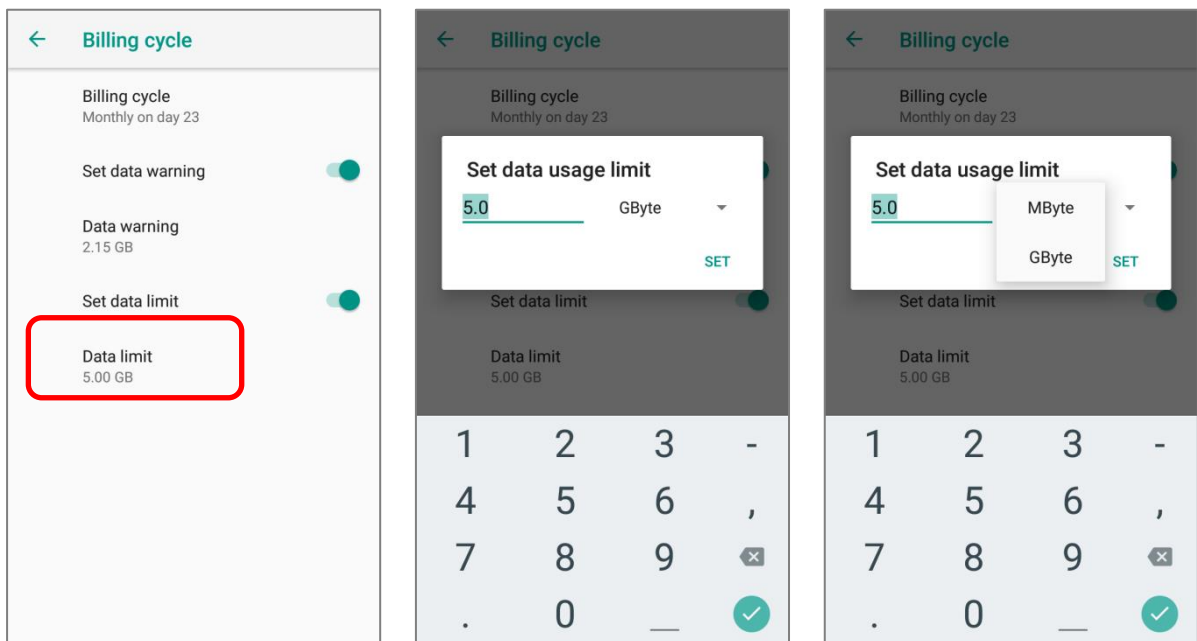

3) Tap "**Data limit**", and input your required limit in "**Set data usage limit**" window, and tap "**SET**". If a limit is set, when the data usage amount reaches the limit, mobile data connection will be automatically disabled.

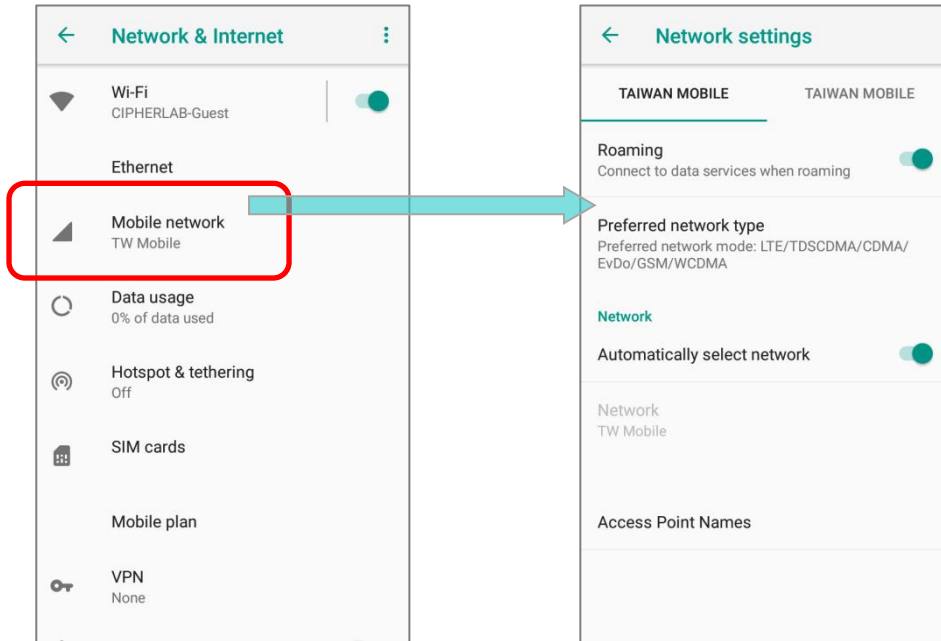

## ENABLE DATA USAGE DURING ROAMING

- 1) Go to [App Drawer \(All Apps\)](#) | **Settings**  | **Network & Internet**  | **Mobile Network**  .



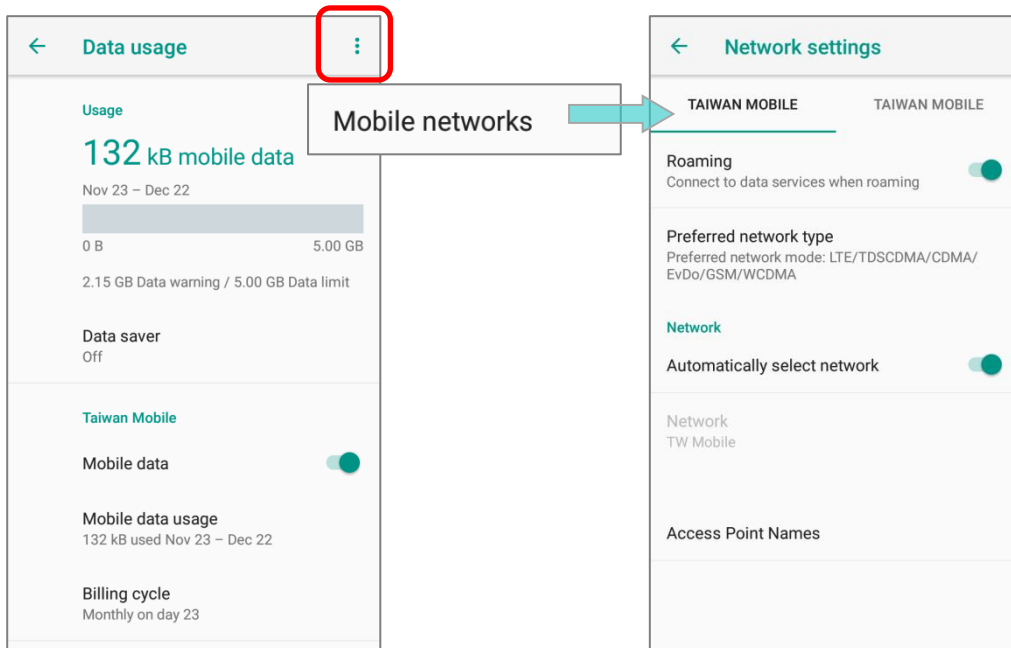

- Or go to [App Drawer \(All Apps\)](#) | **Settings**  | **Network & Internet**  | **Data usage** , and on the **Data usage** page, tap **More**  on the action bar and then "Mobile network".



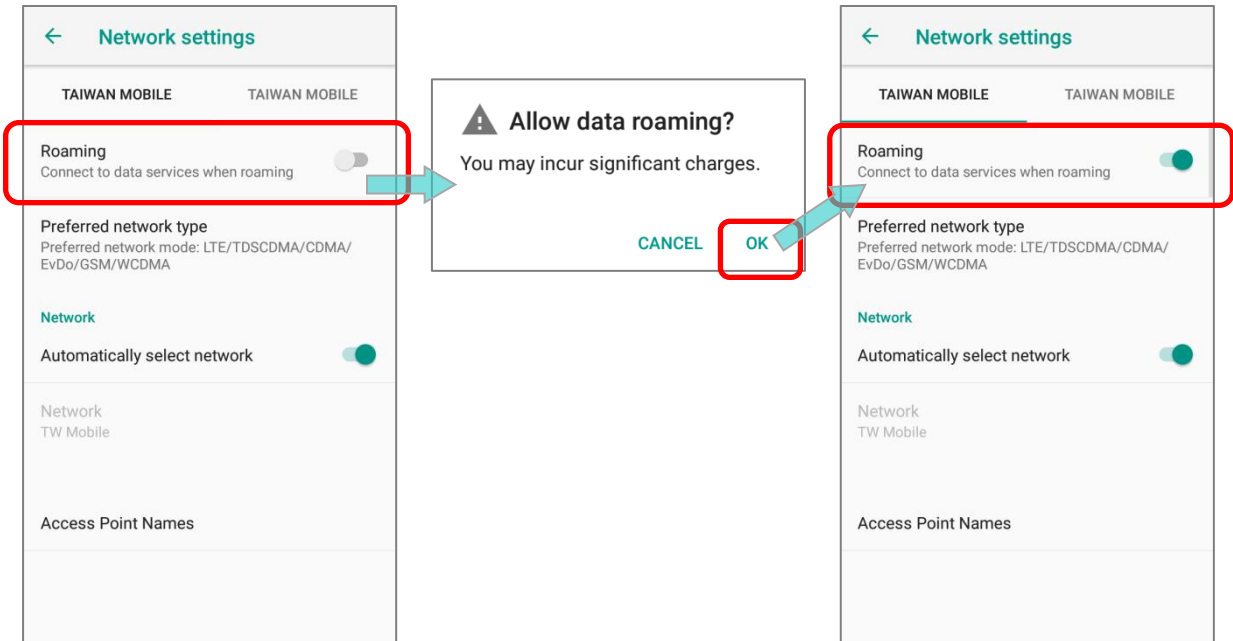

- 2) Tap your mobile carrier tab page, and enable **"Roaming"**. A dialog box appears confirming whether you would like to enable data roaming. Tap **OK** to confirm.

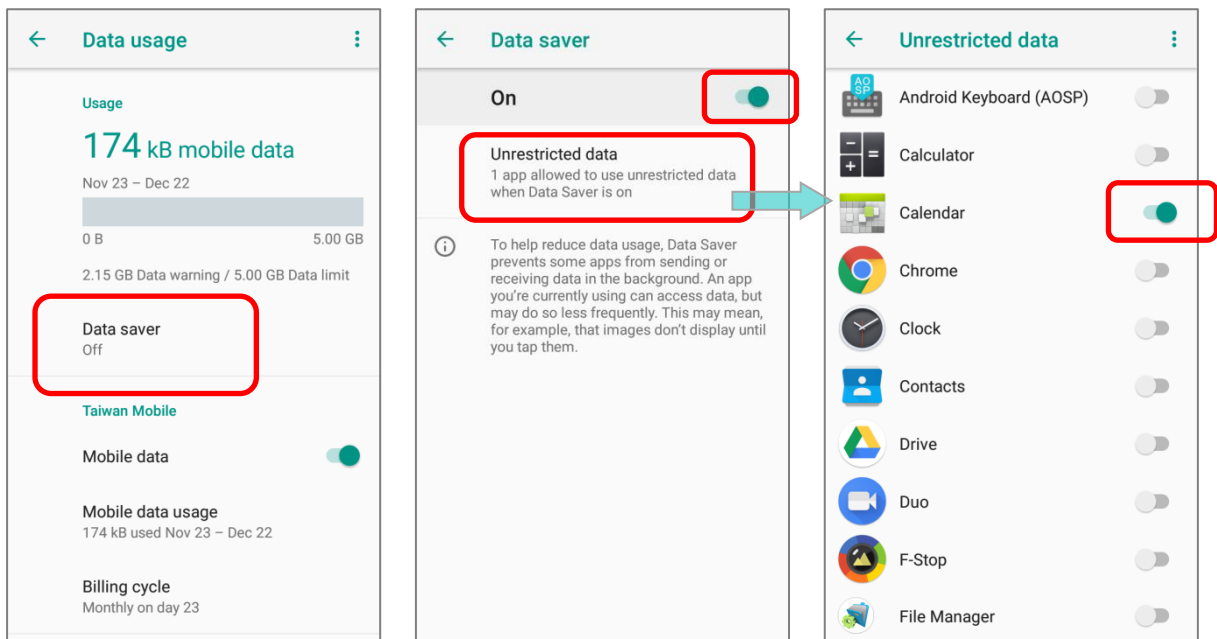

## RESTRICT BACKGROUND DATA

- 1) Go to [App Drawer \(All Apps\)](#) | **Settings**  | **Network & Internet**  | **Data usage** .
- 2) Tap **"Data saver"** and switch data saver to **On**, to restrict background data.
- 3) If there's any applications you would like to keep them activated on background when **"Data saver"** is on, tap **"Unrestrict data access"** to switch them on.



Once "**Data saver**" is on, an status icon  will be shown in the status bar as well as in the Quick Setting menu:

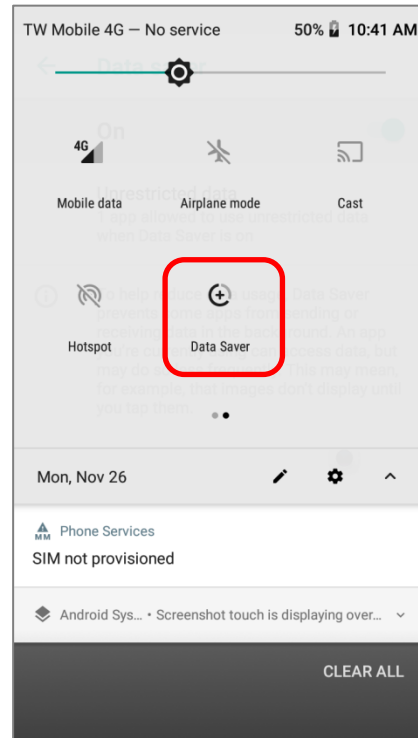
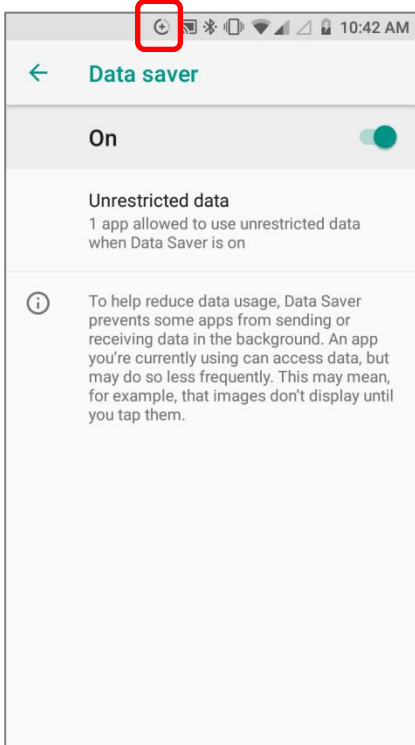

**Note:**



The mobile computer conserves data usage by restricting background mobile data. Certain applications and services will be disabled unless the mobile computer is connected to a Wi-Fi network.



## 4.1.2. DATA CONNECTION SETTINGS

### TURN ON/OFF DATA CONNECTION

To manually turn on/off mobile data connection:

- 1) Go to [App Drawer \(All Apps\)](#) | **Settings**  | **Network & Internet**  | **Data usage** .
- 2) Scroll to the mobile network your are going to check, and tap on "**Mobile data**" to switch it on/off.

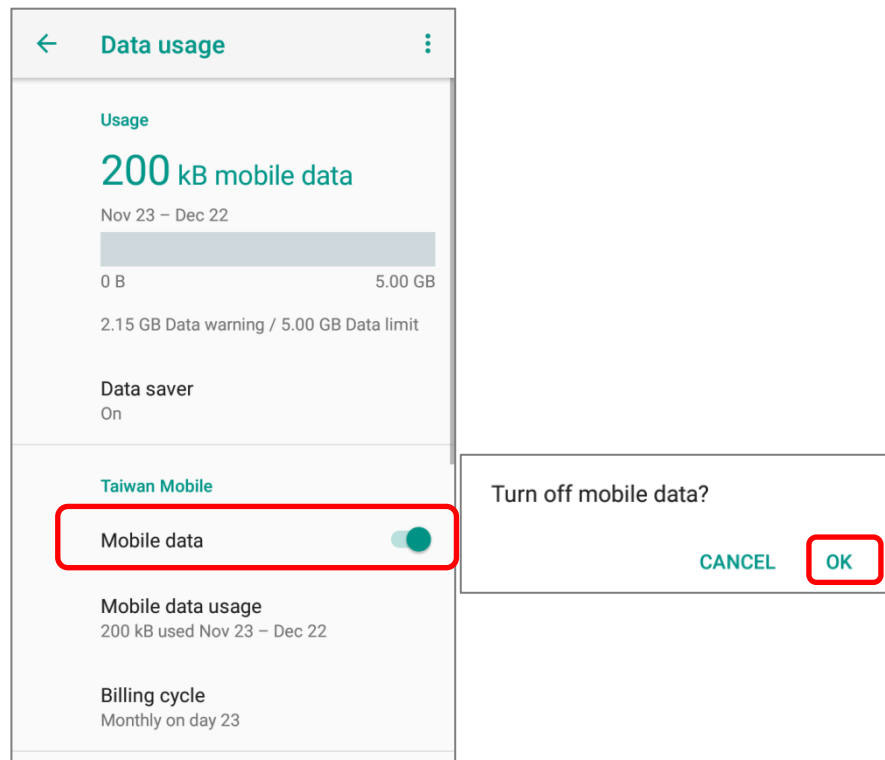

---

---

## SELECT DATA CONNECTION TYPE

1) Go to [App Drawer \(All Apps\)](#) | **Settings**  | **Network & Internet** ,

**OR**

[App Drawer \(All Apps\)](#) | **Settings**  | **Network & Internet**  | **Data usage**  |  
**More**  | **Mobile network**

2) Tap the mobile carrier tab page (if you have 2 SIM cards).

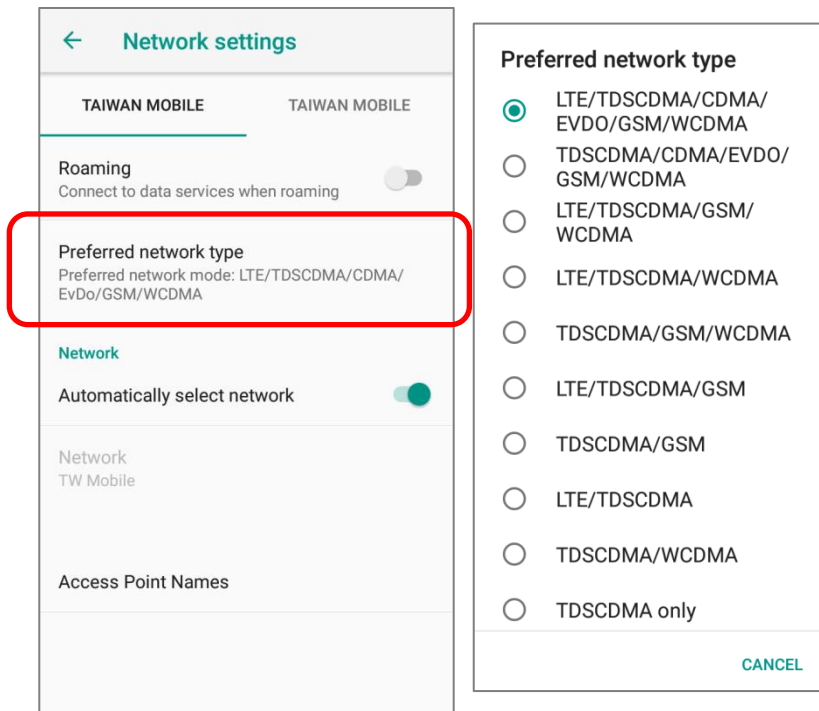

3) Tap Preferred network type to select the setting.



### 4.1.3. SIM CARD SETTINGS

#### LOCK SIM CARD

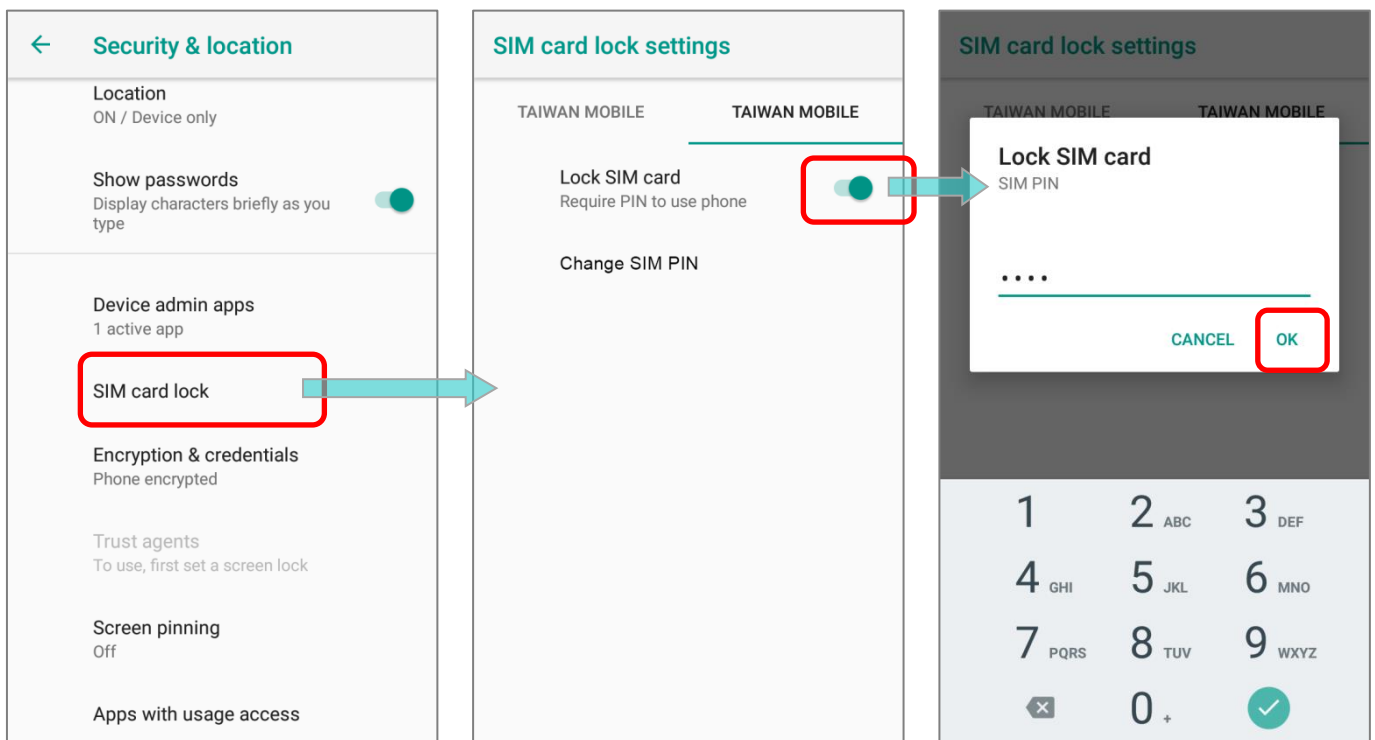

To lock the SIM card:

- 1) Go to [App Drawer \(All Apps\)](#) | **Settings**  | **Security & Location** .
- 2) Scroll down and tap on "**SIM card lock**".
- 3) Tap the mobile carrier tab page (if you have 2 SIM cards), and tap "**Lock SIM card**" to switch it on.
- 4) Enter the PIN to enable SIM card lock. Once enabled, you are required to enter the PIN code in order to use the phone.



## CHANGE PIN CODE

To change the PIN code:

- 1) Go to [App Drawer \(All Apps\)](#) | **Settings**  | **Security & Location** .
- 2) Scroll down and tap on “**SIM card lock**” .
- 3) Tap the mobile carrier tab page (if you have 2 SIM cards), and tap on “**Change SIM PIN**” .
- 4) Enter your old PIN code to confirm your identity, and then input a new PIN code.

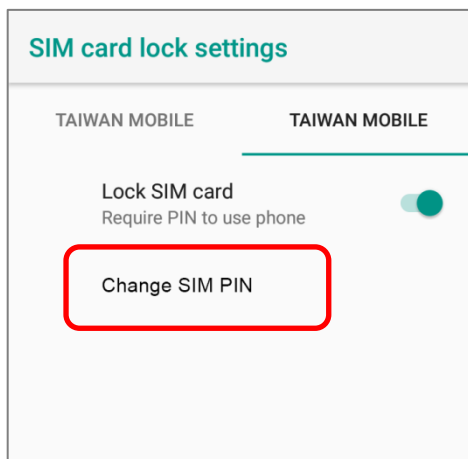

## 4.2. USE WIRELESS LOCAL AREA NETWORK (WI-FI)

### 4.2.1. CONNECT TO WI-FI NETWORK

To power on Wi-Fi:

- 1) Swipe down from the top of the screen to open **Quick Settings Menu**.
- 2) Tap **Wi-Fi** ▼ to scan for available networks. Select a network to connect.

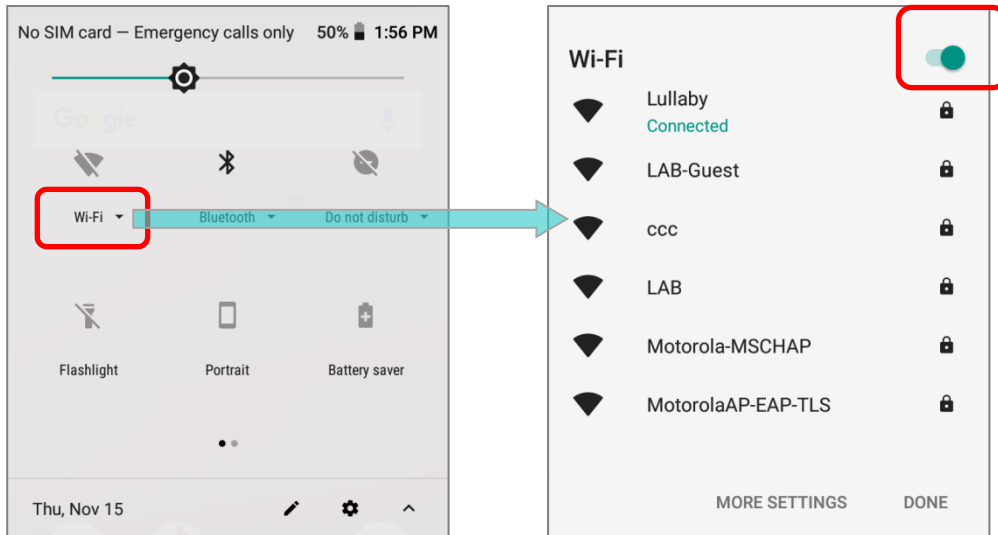

OR

- 1) Tap **App Drawer (All Apps)** | **Settings** ⚙️ | **Network & Internet** 📶 | **Wi-Fi** 📶. Tap the Wi-Fi switch to scan for available networks.

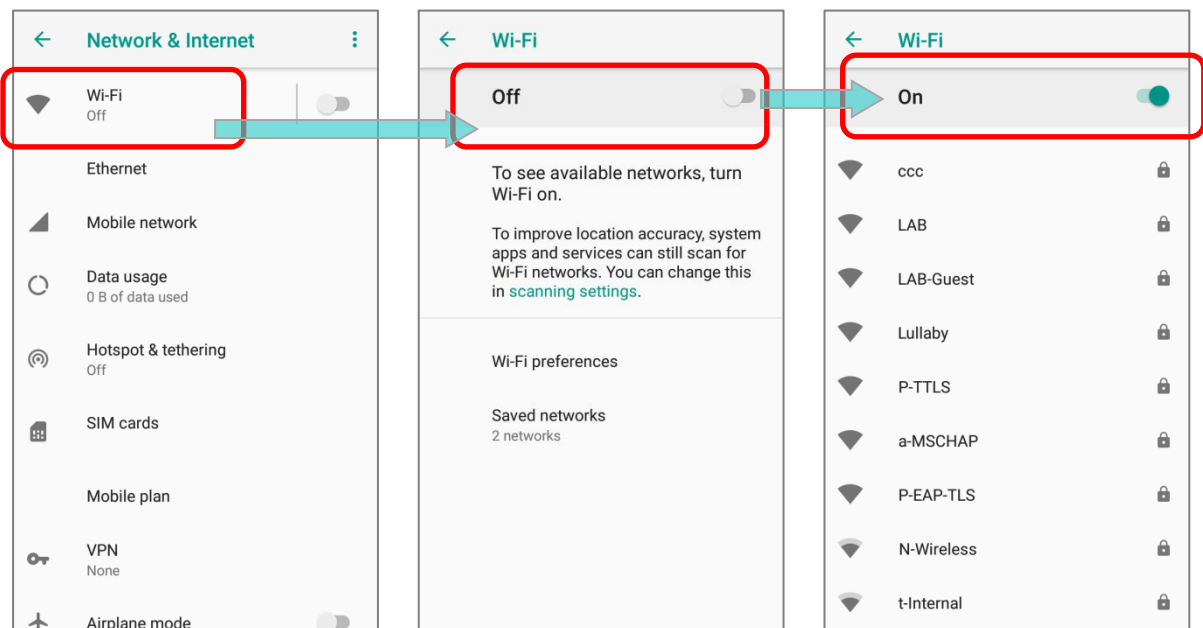

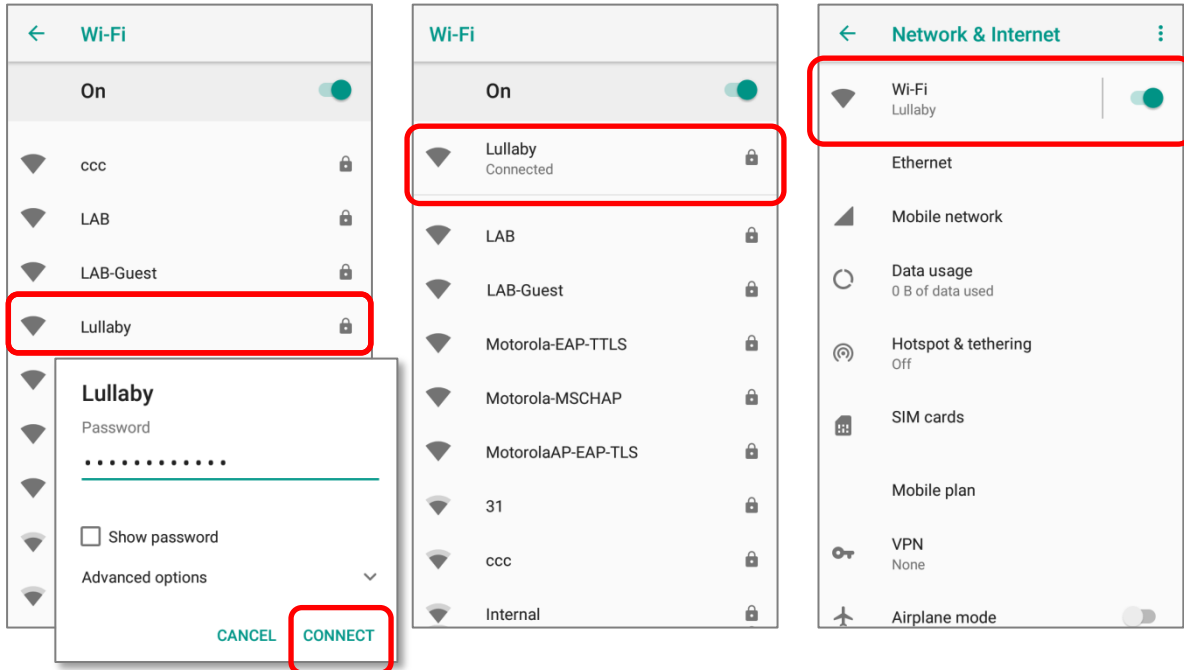

- 2) Select a network to connect. If the network is an open one, the mobile computer will attempt to connect to it directly. When connected, the status will change to show **“Connected”**. If the network is a secured one, the mobile computer prompts a dialog to enter the password for the connection.



## 4.2.2. MANUALLY ADD WI-FI NETWORK

If the network you would like to connect to does not broadcast its SSID, or if the network is out of range, you may add it manually.

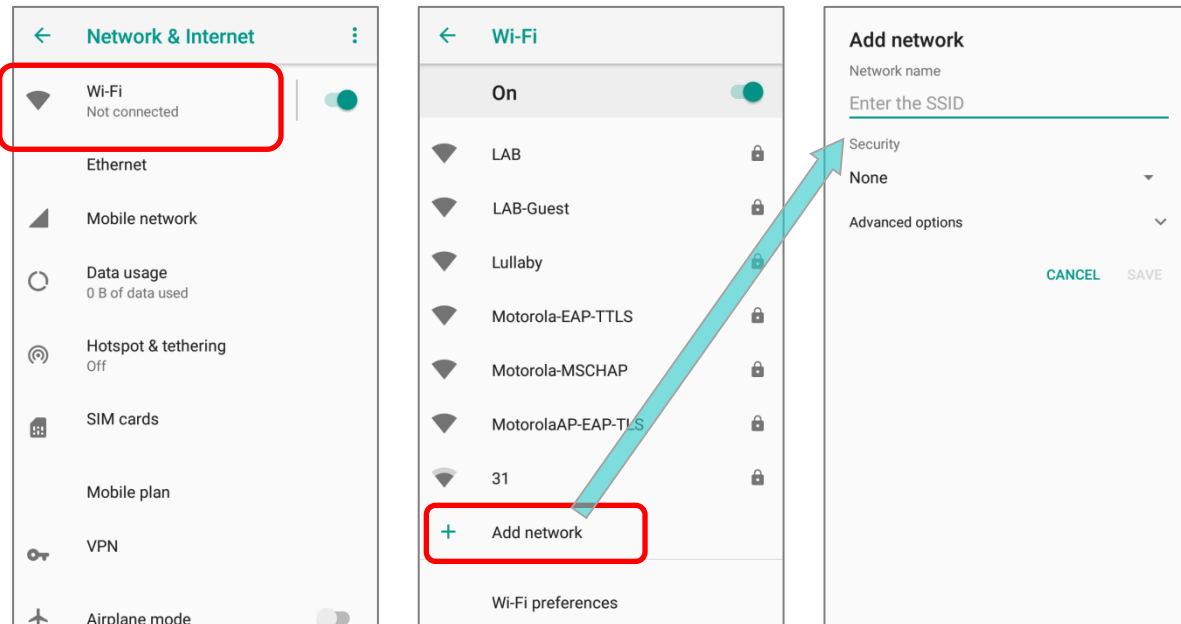

- 1) Go to [App Drawer \(All Apps\)](#) | **Settings**  | **Network & Internet**  | **Wi-Fi**  .  
Tap the Wi-Fi switch to turn it on.
- 2) Scroll down to the bottom of the page, and select **"Add network"**.



- 3) On **"Add network"** page, enter the name of the network in the **Network name** field, and select a security method (None, WEP, WPA/WPA2 PSK, 802.1x EAP).

- ▶ For **WEP/WPA/WPA2 PSK** connections:  
Enter the required password and tap Save.
- ▶ For **802.1x EAP** connections:  
Select the **EAP method** in the drop-down box (PEAP, TLS, TTLS, PWD, SIM, AKA), and the **Phase 2 authentication** in the drop-down box (None, MSCHAPV2, GTC). Select a **CA certificate** and User certificate if required.

(certificates may be installed under:

[App Drawer \(All Apps\)](#) | **Settings**  | **Network & Internet**  | **Wi-Fi**  | **Wi-Fi preferences** | **Advanced** | **Install certificates.**)

Enter your username in the Identity box and the password in the Password box if required.

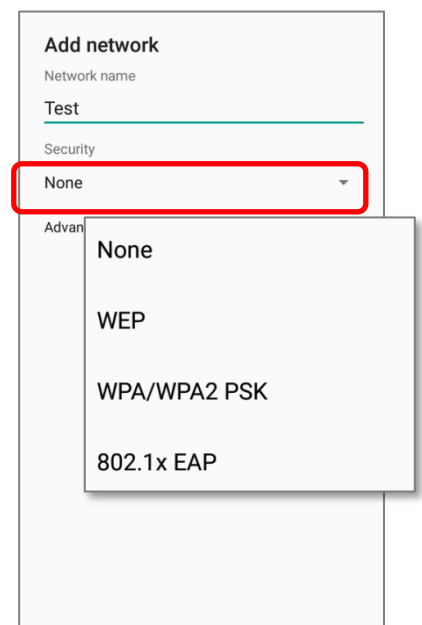

The mobile computer supports the following certificate file extensions:

File Extension Type	Standard Certificate	Key Stored
<b>Description</b>	DER-encoded X.509 certificates saved in .crt or .cer files.	X.509 certificates saved in PKCS#12 key store files with a .p12 or .pfx extension.
<b>How to install</b>	change the extension to .crt or .cer.	Change the extension to .p12 or .pfx.

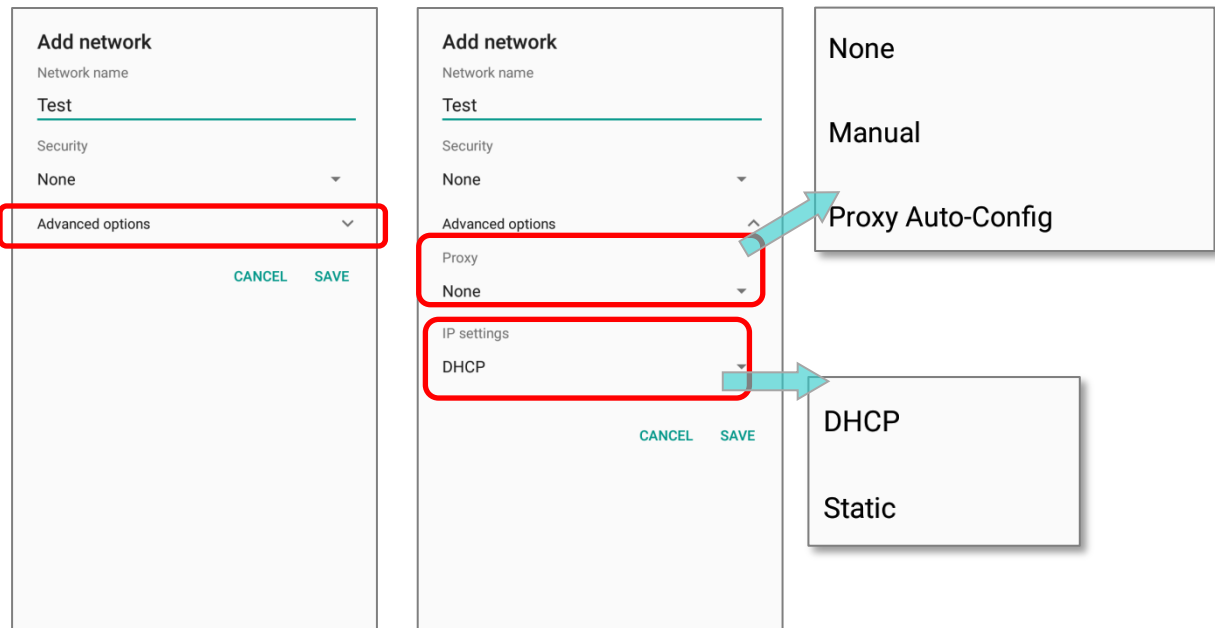

4) If necessary, select the **Proxy** server and **IPv4** settings. By default, no proxy is set and IP settings are set to **DHCP**.





### 4.2.3. WI-FI PREFERENCES

To access advanced Wi-Fi settings:

- 1) Go to [App Drawer \(All Apps\)](#) | **Settings**  | **Network & Internet**  | **Wi-Fi**  |
- 2) Scroll down to the bottom of the page, and tap on **"Wi-Fi preferences"**.
- 3) Tap **"Advanced"** to expand more settings. Available settings are as below:

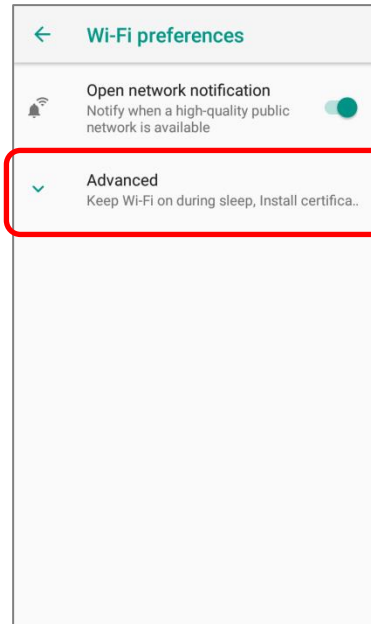
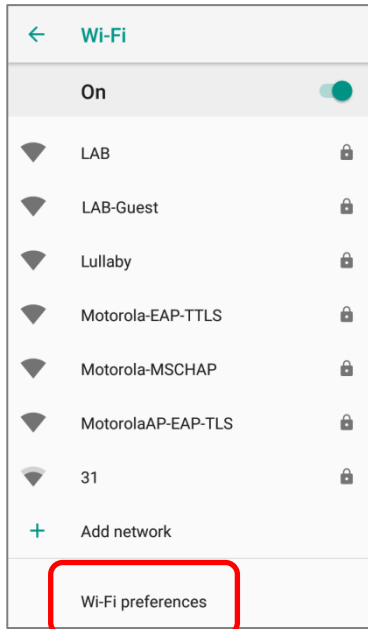

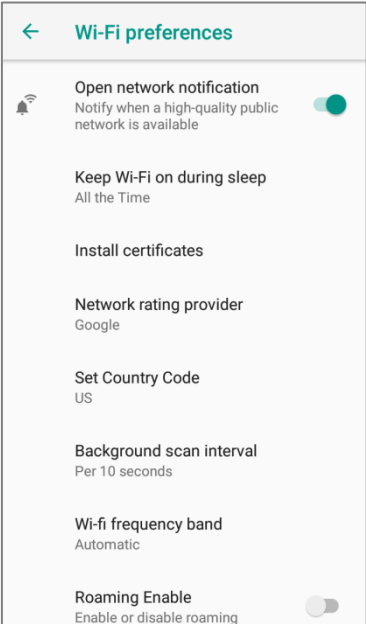
	Item	Description
	<b>Open network notification</b>	Notify when an open network is available.
	<b>Keep Wi-Fi on during sleep</b>	Set when to turn Wi-Fi on during sleep.
	<b>Install certificates</b>	Installs certificates recently downloaded or placed on the internal storage.
	<b>Network rating provider</b>	The selected network scorers will label the the quality of the open Wi-Fi networks you are connecting to between very fast and slow.
	<b>Set Country Code</b>	Select the Wi-Fi country code for your device. The default country code setting is set by your SIM card automatically.
	<b>Background scan interval</b>	The frequency of background scan when the device does not connect the internet. The shorter time means the scanning frequency is higher.
	<b>Wi-Fi frequency band</b>	Select <b>Automatic</b> , <b>5 GHz</b> , or <b>2.4 GHz</b> for your Wi-Fi frequency band. The default setting is Automatic.

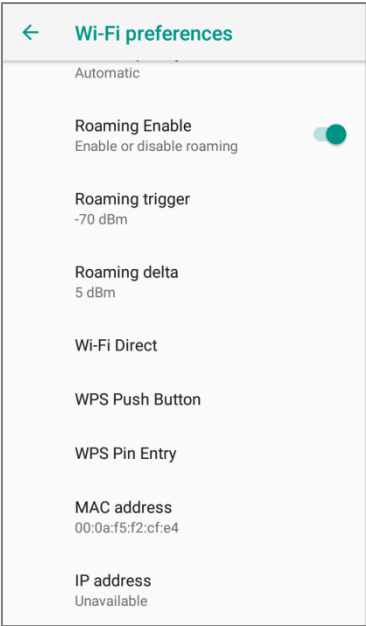

Item	Description
<b>Roaming Enable</b>	Select whether to enable Wi-Fi roaming or not.
<b>Roaming trigger</b>	The signal strength when triggering Wi-Fi roaming. The higher value means the sensitivity of triggering roaming is higher.
<b>Roaming delta</b>	The qualification for roam candidates. The higher value means the signal strength of candidate APs should be higher than the current connected AP.
<b>Wi-Fi Direct</b>	Enables your device to connect with a Wi-Fi Direct-capable device.
<b>WPS Push Button</b>	Initialize the Wi-Fi protected setup (WPS) for a WPS-capable network. You will also have to press down the WPS button on your router.
<b>WPS Pin Entry</b>	Enter the personal identification number (PIN) for Wi-Fi protected setup (WPS) process.
<b>MAC address</b>	Displays the MAC address of the device when connecting to Wi-Fi networks.
<b>IP address</b>	Displays the IP address of the device.

#### 4.2.4. CONFIGURE PROXY SERVER

A proxy server acts as an intermediary between an endpoint device and another server from which the device is requesting a service.

To change the proxy settings for a connection:

- 1) Long press on a network in the available Wi-Fi hotspot list, and then tap on "**Modify network**".
- 2) Tap on "**Advanced options**" to expand the detailed settings.
- 3) Tap **Proxy** and select **Manual**.
- 4) Enter the address of the proxy server in the **Proxy hostname** field. Enter the port number for the proxy server in the **Proxy port**. Enter the addresses of websites which are allowed to bypass the proxy server in the **Bypass proxy for** field. (Use the separator | between addresses.)
- 5) Tap **SAVE**.



#### 4.2.5. USE STATIC IP ADDRESS

By default, the device gets an IP address from DHCP when connecting to a wireless network. You may set for the device to connect to a network using a static IP address.

- 1) Long press on a network in the available Wi-Fi hotspot list, and then tap on "**Modify network**".
- 2) Tap on "**Advanced options**" to expand the detailed settings.
- 3) Tap **IP settings** and select **Static**.
- 4) Enter the IP address, gateway, network prefix length, DNS 1 address and DNS 2 address in the fields provided.
- 5) Tap **SAVE**.

#### 4.2.6. CONNECT WITH WI-FI PROTECTED SETUP (WPS)

Wi-Fi Protected Setup (WPS) allows easy establishment of a secure wireless network. The mobile computer supports WPS Push Button configuration.

- 1) Go to [App Drawer \(All Apps\)](#) | **Settings**  | **Network & Internet**  | **Wi-Fi**  | **Wi-Fi preferences**
- 2) Tap on **Advanced** to expand and then **WPS Push Button**.
- 3) A dialog will pop-up on the screen showing the remaining time allowed for pressing the WPS button on the router.

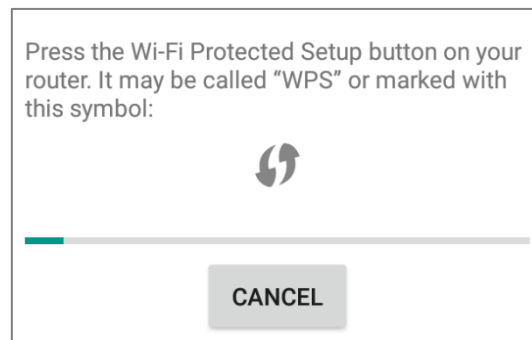

- 4) On your wireless router, press the WPS button. The device will connect to your router.

#### 4.2.7. MODIFY WI-FI NETWORK

To change the settings for a connected network:

- 1) Tap and hold a connected network in the Wi-Fi hotspot list.
- 2) Tap **Modify network** in the pop-up menu.
- 3) In the dialog box that opens, modify the network settings, and tap **Save**.

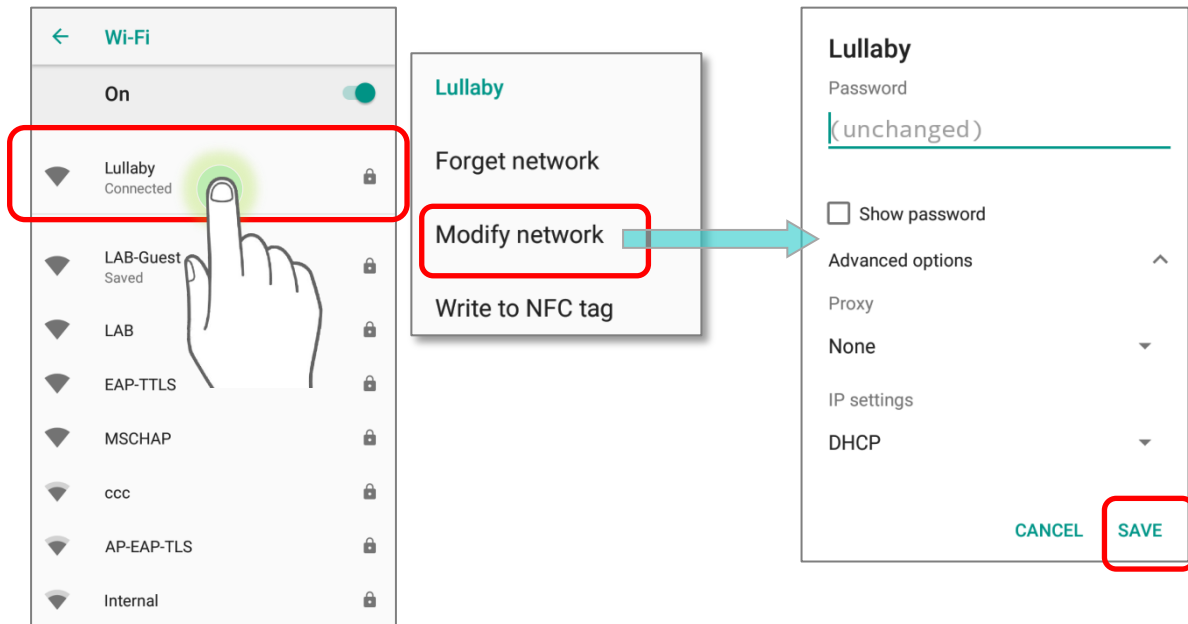

#### 4.2.8. DISCONNECT WI-FI NETWORK

To disconnect a connected network:

- 1) Tap and hold a connected network in the Wi-Fi hotspot list.
- 2) Tap **Forget network** in the pop-up menu.

## 4.3. USE BLUETOOTH

You can configure Bluetooth settings and manage Bluetooth services provided on remote devices.

### 4.3.1. BLUETOOTH PROFILES

#### Bluetooth Profiles Supported

Generic Access Profile	(GAP)	For device discovery and authentication.
Service Discovery Access Profile	(SDAP)	Discovers services on remote devices.
Headset Profile	(HSP)	Describes how a Bluetooth enabled headset should communicate with a Bluetooth enabled device
Hands-Free Profile	(HFP 1.6)	Allows using a hands-free device to place and receive calls.
Serial Port Profile	(SPP)	Sets up a virtual serial port to connect two Bluetooth devices.
Generic Object Exchange Profile	(GOEP)	Provides a basis for other data profiles.
Object Push Profile	(OPP)	Pushes and pulls objects to and from a push server.
Hands Free Profile	(HFP)	Connects the Audio Gateway device to the Hands Free device.
Personal Area Networking Profile	(PAN)	Uses Bluetooth Network Encapsulation Protocol for Bluetooth transmission.
Advanced Audio Distribution Profile	(A2DP)	Streams stereo-quality audio to a wireless headset or speaker.
Audio Video Remote Control Profile	(AVRCP)	Allows controlling of television and Hi-Fi equipment.
General Audio/Video Distribution Profile	(GAVDP)	Provides a basis for A2DP and VDP.
Human Interface Device Profile	(HID)	Provides a low latency Bluetooth connection with keyboards, pointing devices, etc.
Phone Book Access profile	(PBAP)	Transfers Phone Book Objects to a car kit to display the information of an incoming call received on the mobile computer, or initiate a call.
Out of band and Near Field Communications	(OOB, NFC)	Manages the pairing process by using NFC.
Symbol Serial Interface Profile	(SSI)	Supports additional scanner.
Human Interface Device Profile	(HID)	Provides a low latency Bluetooth connection with keyboards, pointing devices, etc.
Dial-up Networking Profile	(DUN)	Provides a standard to access the Internet and other dial-up services over Bluetooth.

### 4.3.2. TURN ON BLUETOOTH

By default, Bluetooth is turned off, to turn it on:

#### Via Quick Settings Panel:

- 1) Swipe down from the top of the screen to open **Quick Settings Panel**.
- 2) Tap on **Bluetooth** icon to turn it on or off.

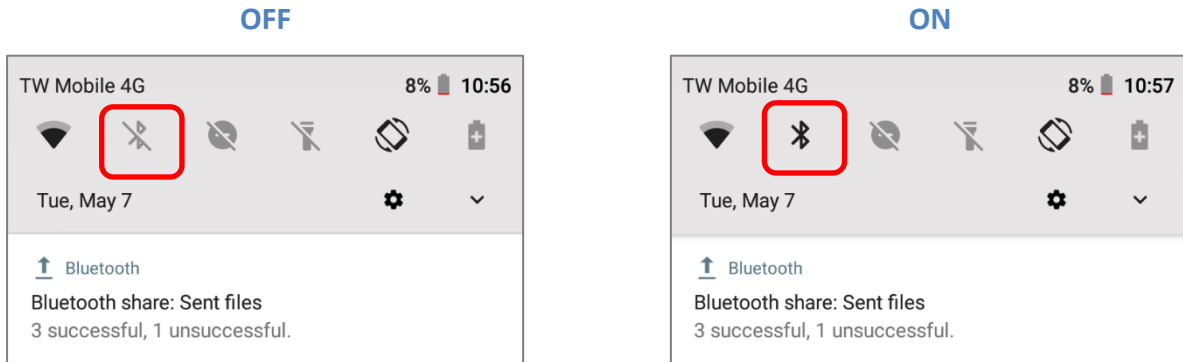

#### Via Quick Settings Menu:

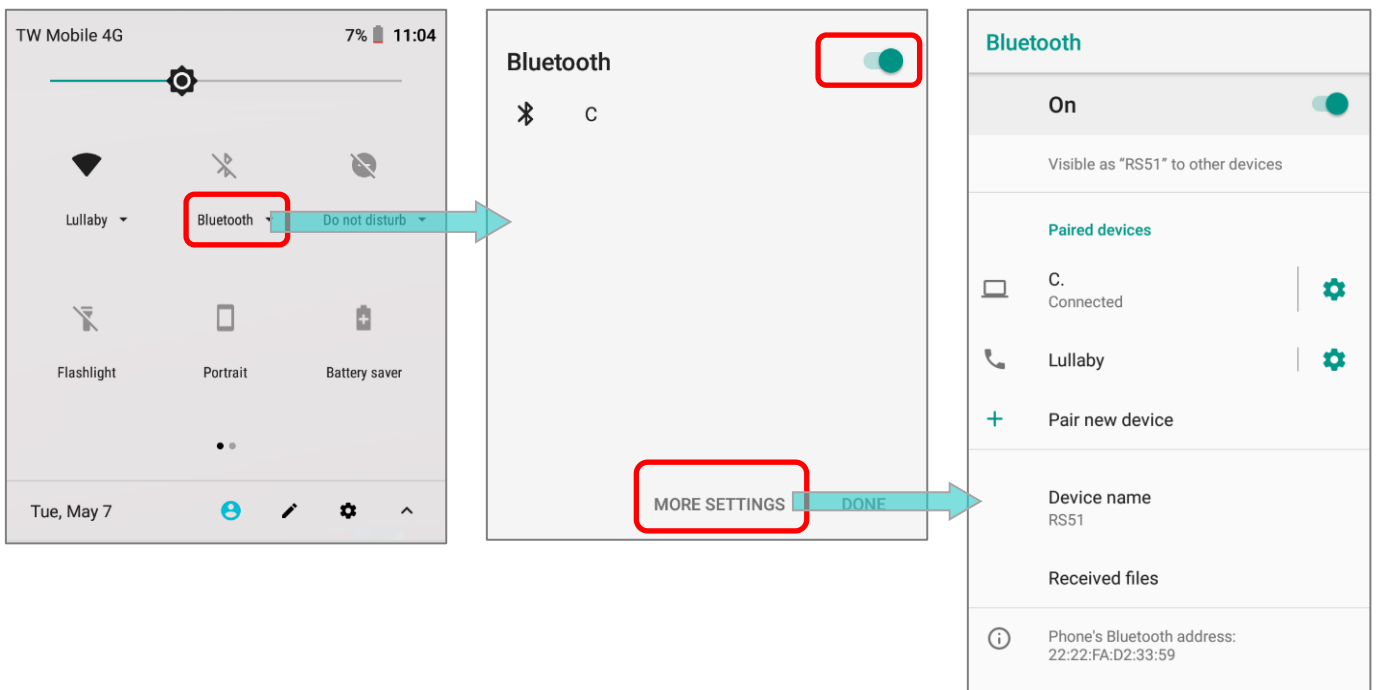

- 1) Swipe down to open **Quick Settings Menu**.
- 2) Tap **Bluetooth** icon to turn it on while enabling the Bluetooth visibility of this device.



OR

Tap "**Bluetooth** ▼" under to enter "**Bluetooth**" page to switch this function on/off.  
Tap "**More Settings**" for detailed settings.

**Via Settings page:**

- 1) Go to [App Drawer \(All Apps\)](#) | **Settings**  | **Connected devices**  | **Bluetooth** .
- 2) Tap the switch to turn on this function while enabling the Bluetooth visibility of this device.

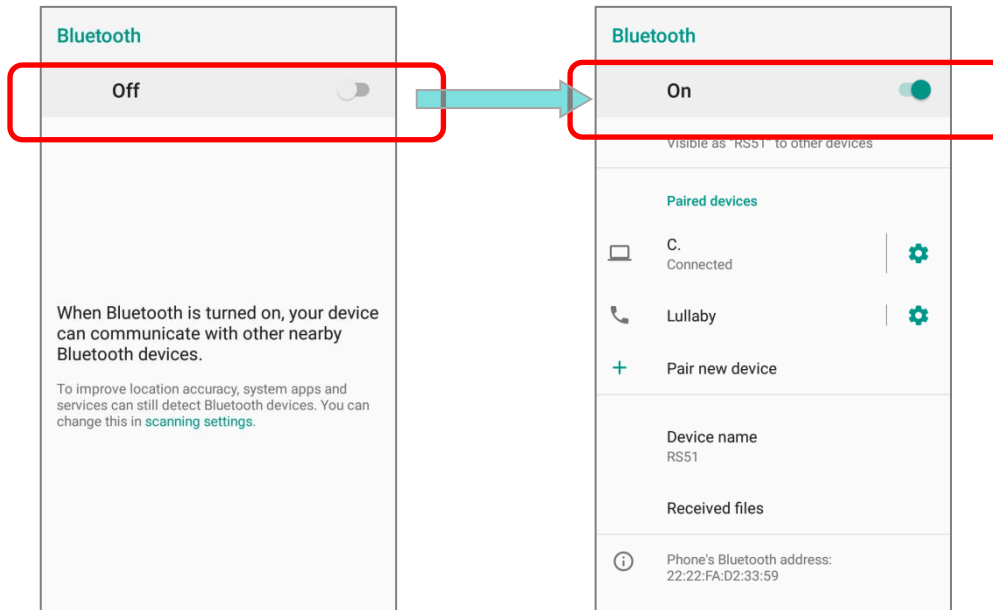

**OR** simply switch **Bluetooth** on/off in [App Drawer \(All Apps\)](#) | **Settings**  | **Connected devices** .

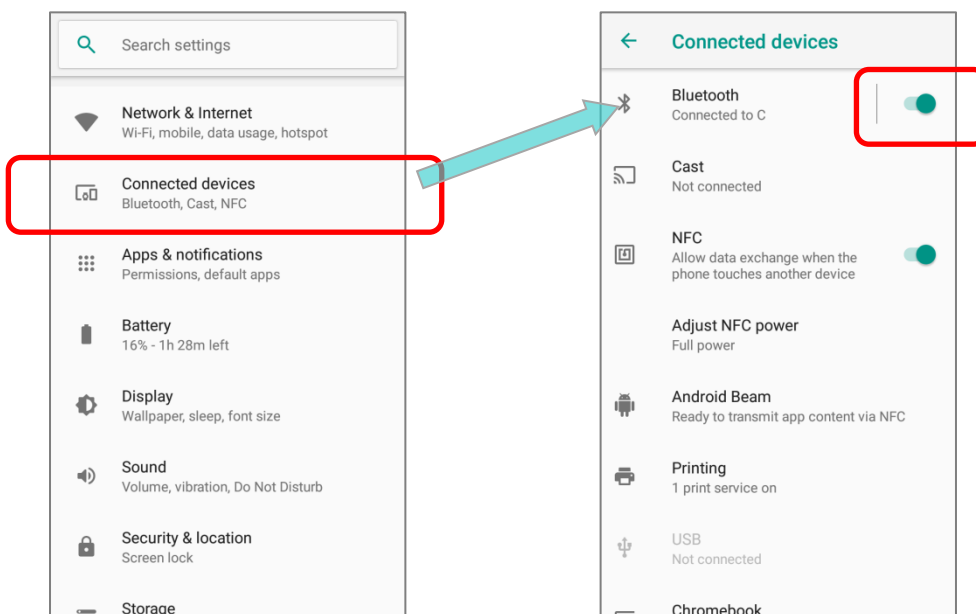



**Note:** Having been turned on, Bluetooth is active even when the mobile computer is suspended. However, if the power mode is switched to Airplane Mode, Bluetooth power will be turned off regardless of the settings.



### 4.3.3. CHANGE BLUETOOTH NAME

To change the Bluetooth name of this mobile computer:

- 1) Go to [App Drawer \(All Apps\)](#) | **Settings**  | **Connected devices**  | **Bluetooth** .
- 2) Turn **Bluetooth** on and tap on "**Device name**".
- 3) On the pop-up dialog "**Rename this device**", type a new name in the field and tap **RENAME**.

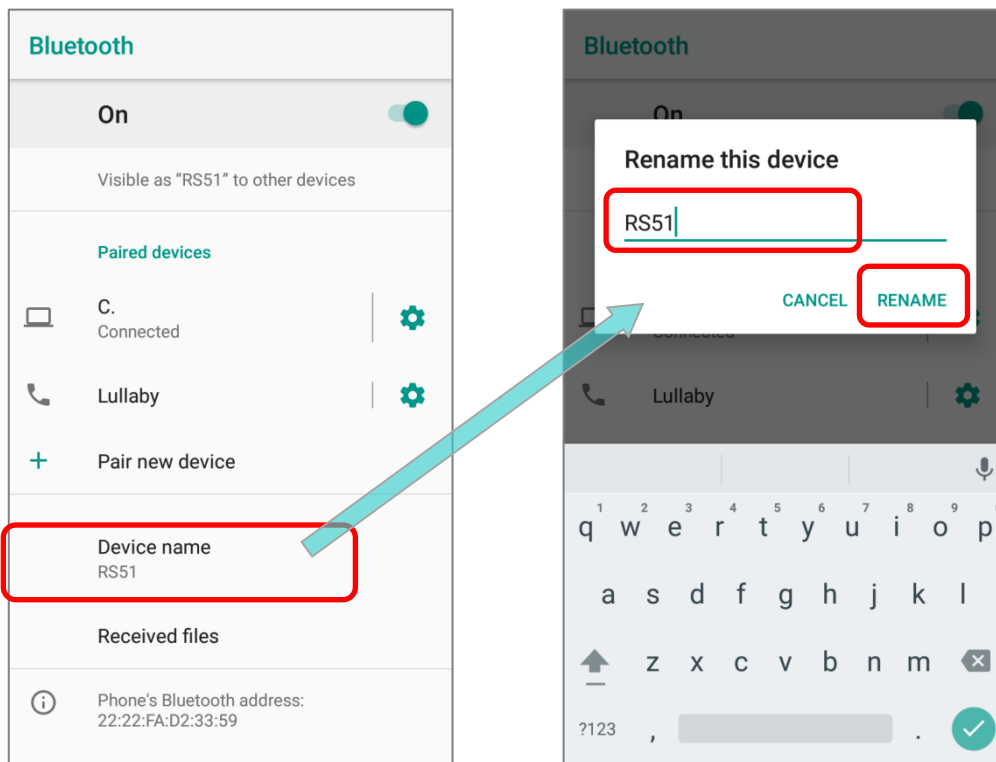

### 4.3.4. PAIR BLUETOOTH DEVICES

- 1) Go to [App Drawer \(All Apps\)](#) | **Settings**  | **Connected devices**  | **Bluetooth** .
- 2) Switch **Bluetooth** to **On** and tap **"Pair new device"** to scan for available Bluetooth devices nearby. Scroll through the list and tap the device you would like to pair.

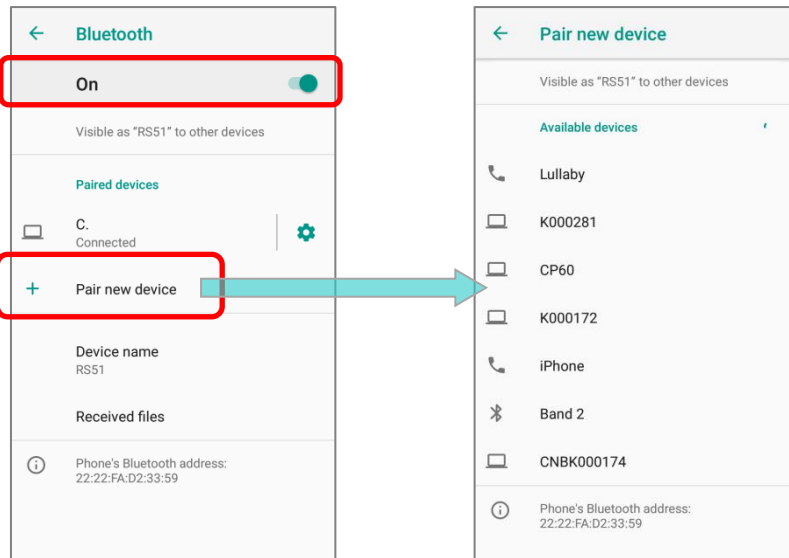

- 3) The **Bluetooth pairing request window** opens. Depending on the pairing settings of the Bluetooth device, you may need to enter a passkey, or confirm the assigned passkey on the device to pair if a smart pairing method is applied. Enter/confirm the passkey on the device to pair.

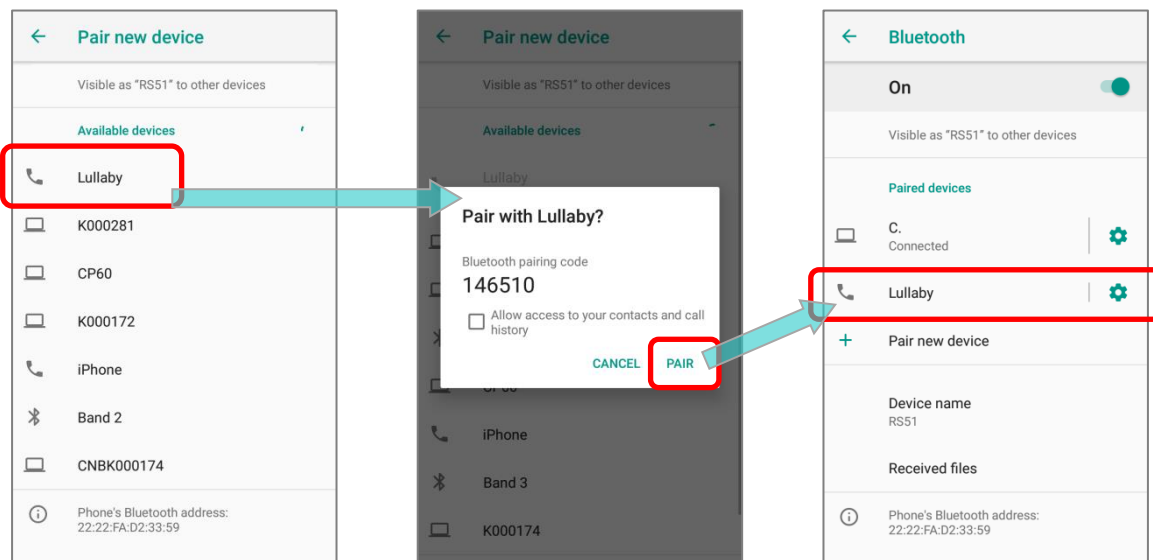

- 4) Once pairing is done, the Bluetooth device will be listed in the Paired Devices list.

**Note:** If the device you would like to pair with is not listed, make sure Bluetooth visibility is enabled on the device.

4.3.5. UNPAIR BLUETOOTH DEVICE

To unpair a paired device:

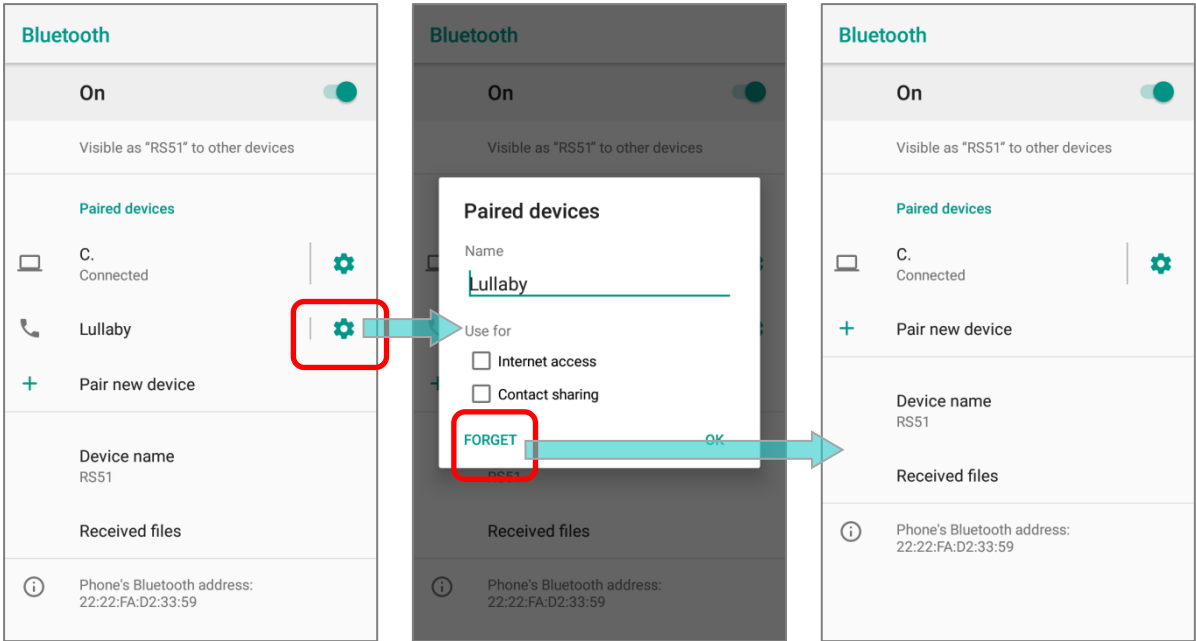

- 1) In the **Paired Devices** list, tap the settings button  next to the paired device.
- 2) On the **Paired device** screen, tap **FORGET**.



#### 4.4. USE NEAR FIELD COMMUNICATIONS

Near field communications (NFC) uses close proximity (4 cm or less) to establish radio communication through electromagnetic fields. With NFC enabled, the mobile computer can collect information from NFC tags, exchange information with other NFC supported devices, and even change information on the NFC tag if authorized.

Before starting to communicate through NFC, perform the following:

- 1) Go to [App Drawer \(All Apps\)](#) | **Settings**  | **Connected devices** .
- 2) On **"Connected devices"** page, tap to switch on **"NFC"** . NFC power is adjustable by tapping on **"Adjust NFC power"**.

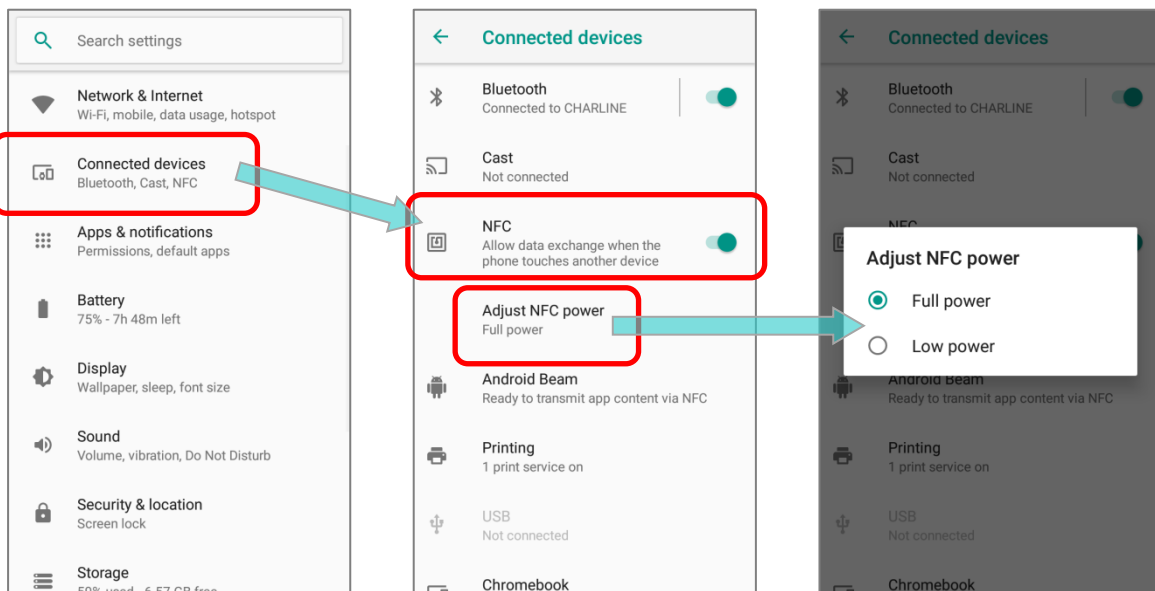

- 3) On **"Connected devices"** page, tap **Android Beam**  and enable it.

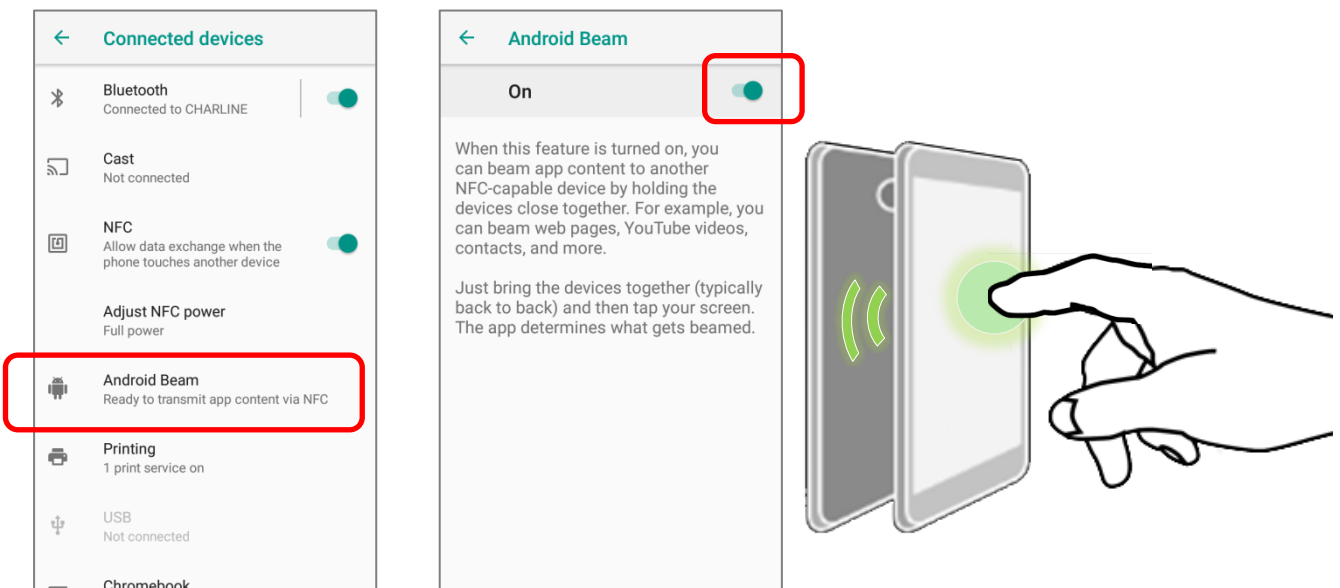

#### 4.4.1. PAIR WITH NFC ENABLED BLUETOOTH DEVICES

- 1) On the device you would like to pair with, make sure NFC is enabled and Bluetooth discovery is enabled.
- 2) Hold the mobile computer without covering the antenna area at the lower end of the battery.
- 3) Move the mobile computer in proximity with the device. A screen notification will appear to indicate that pairing is successful.

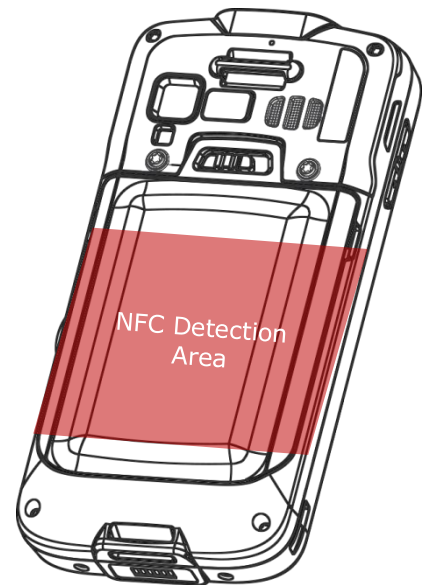

#### 4.4.2. SHARE INFORMATION

- 1) Open the web page, video, photo or contact info page you would like to transfer.
- 2) Place the back of the mobile computer in close proximity with the other device you would like to share data with.
- 3) When the two devices connect, a "**Touch to beam**" notification will appear on the screen.
- 4) Touch the screen to initiate data transfer.

**Note:**

Once the data begins to transfer, just keep the two devices in the distance within 10 m (32.8 ft.); they no longer have to be held within close range in order to transfer successfully.

#### 4.4.3. COMMUNICATION WITH NFC

- 1) On the mobile computer, launch an NFC enabled application.
- 2) Hold the mobile computer without covering the antenna area at the lower end of the battery.
- 3) Place the mobile computer close to the NFC tag or device until the application indicates data transfer is complete.

## Chapter 5

### USING THE PHONE

---

The RS51 mobile computer allows making phone calls and connecting to the network over Wideband Code Division Multiple Access (WCDMA). Insert the SIM card before turning on the power. Refer to [Installing SIM Card, SAM Card and Memory Card](#).

---

**Note:**

- 1) If the SIM card is not in position, you may make emergency calls if the service is supported.
  - 2) Wi-Fi only model doesn't support phone application.
- 

#### IN THIS CHAPTER



---

5.1 SIM Card Management .....	151
5.2 Phone Application.....	154
5.3 Audio Modes.....	163
5.4 In-call Volume .....	164



## 5.1. SIM CARD MANAGEMENT

The mobile computer accommodates two SIM cards and supports dual standby of two different networks. Both networks will be monitored at the same time, and the phone will dynamically switch between the two networks during usage. Calls will be placed with either one of the networks; you cannot switch networks in the middle of a received call or placed call, or receive or place calls with both networks at the same time.

If dual SIM card is inserted, a confirmation page appears for user to select the preferred SIM card for 4G/3G subscription.

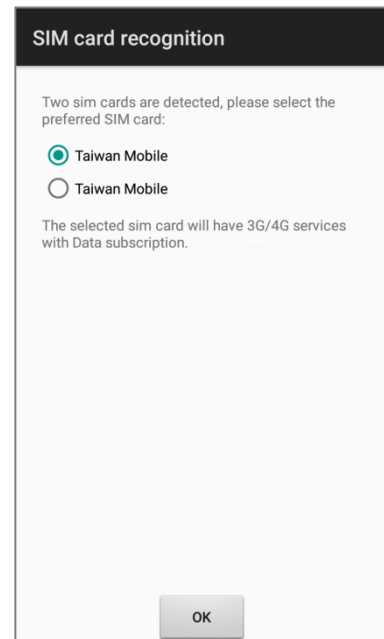
You can make change later in [App Drawer \(All Apps\)](#) | **Settings**  | **Network & Internet**  | **SIM cards**  | **Default 4G/3G Subscription**:



- 1) To open the SIM card management screen, please go to [App Drawer \(All Apps\)](#) | **Settings**  | **Network & Internet**  | **SIM cards** .
- 2) If you already have both SIM1 and SIM2 cards inserted, enable these cards on SIM cards screen and respectively select the **Preferred SIM for** : "**Default 4G/3G Subscription**", "**Calls**" and "**SMS messages.**"

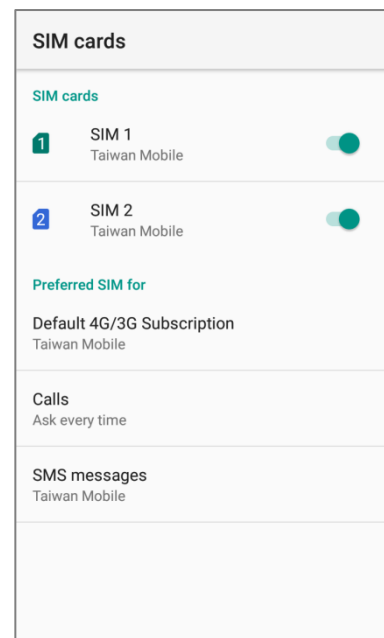



### Note:

When both SIM cards are inserted and enabled, they are active and ready to receive an incoming call but not able to be connected at the same time.

## CELLULAR NETWORKS SETTINGS

The default setting for cellular networks is **"Automatically select network"**. To manually select the cellular network, please:

- 1) Go to [App Drawer \(All Apps\)](#) | **Settings**  | **Network & Internet**  | **Mobile Network** .
- 2) Disable **"Automatically select network"**, and tap on **"Network"**. Available networks will be listed after searching.
- 3) Select your preferred network from the list.

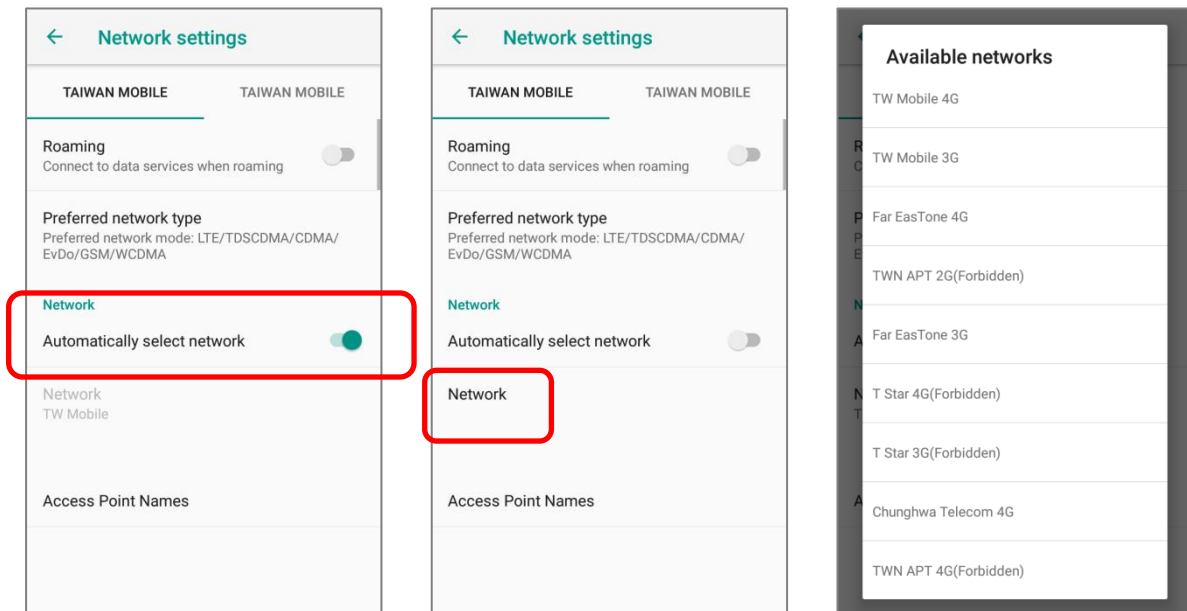

- 4) A notification appears if the selected network is unavailable. Please repeat the aforesaid steps to select the network again.

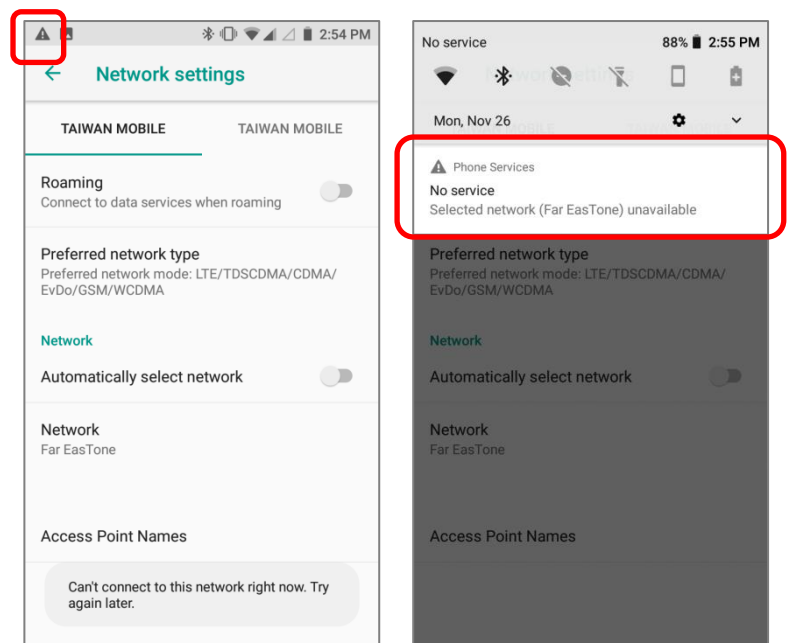



## EMERGENCY CALLS



Depending on your service provider, the mobile computer might support making emergency phone call when the SIM card is locked, or even when no SIM card is inserted. Emergency phone numbers will vary by country.

## 5.2. PHONE APPLICATION

### 5.2.1. PHONE INTERFACE

When a SIM card is installed on the mobile computer, a signal icon appears on the status bar. The filled part of the signal icon indicates the strength of the connection.

To make phone calls:

- 1) Go to [App Drawer \(All Apps\)](#) | **Phone** . The Phone application opens.
- 2) Tap the settings button  to open the phone settings menu for more setting options.
- 3) Tap  to open the dial pad.

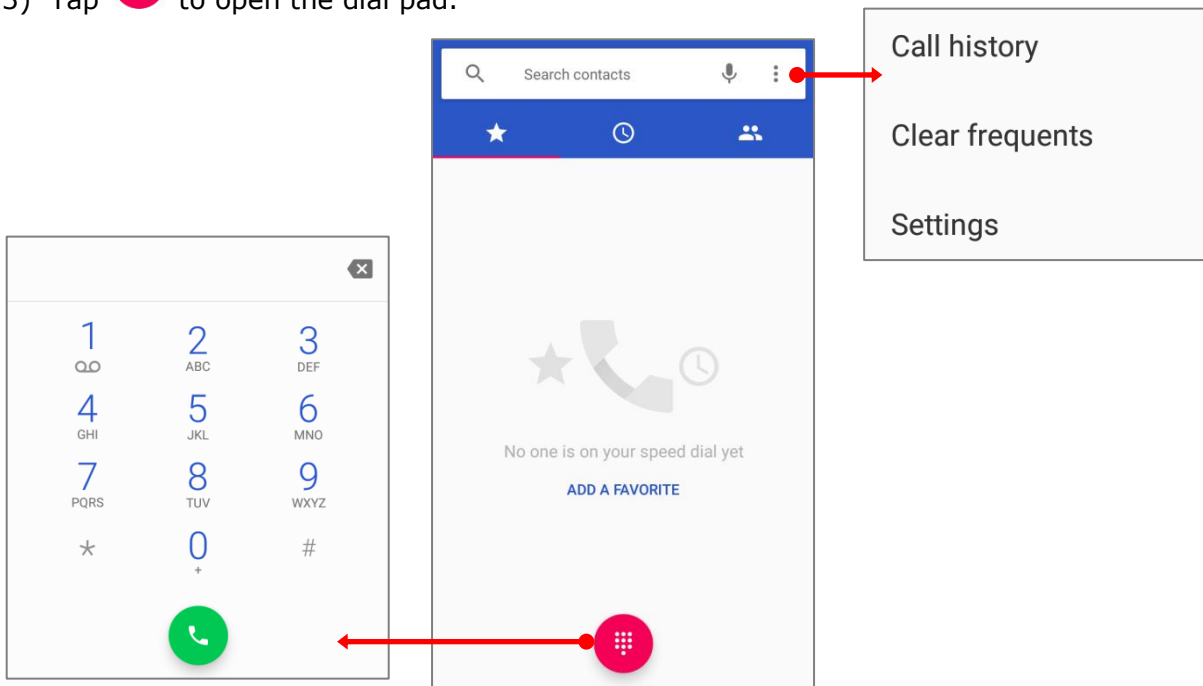

In  tab page, it displays your favorite contacts & your frequent calls:

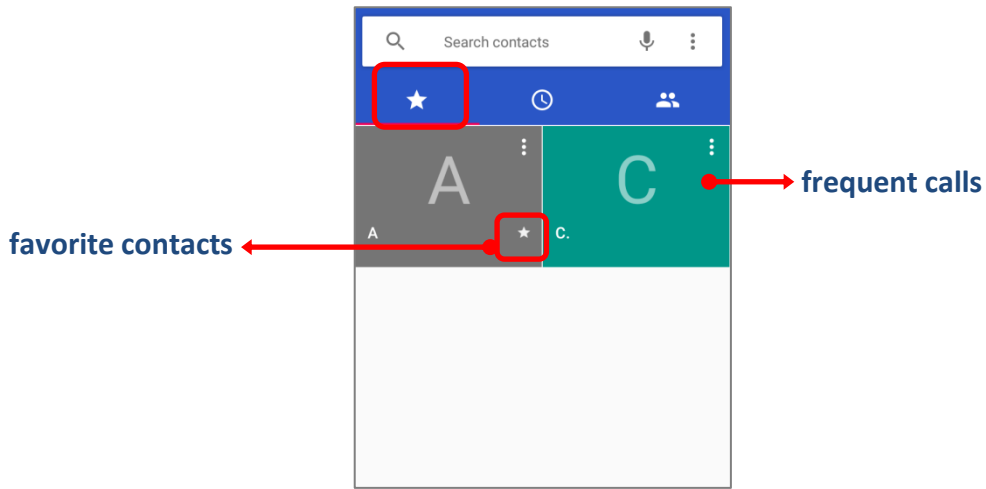

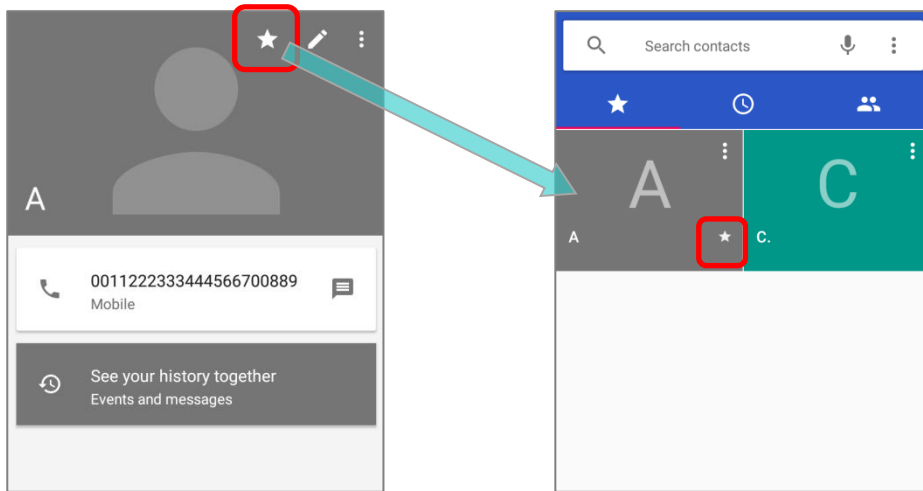

To add a favorite contact, please tap the contact in  tab page and tap the star mark to add.

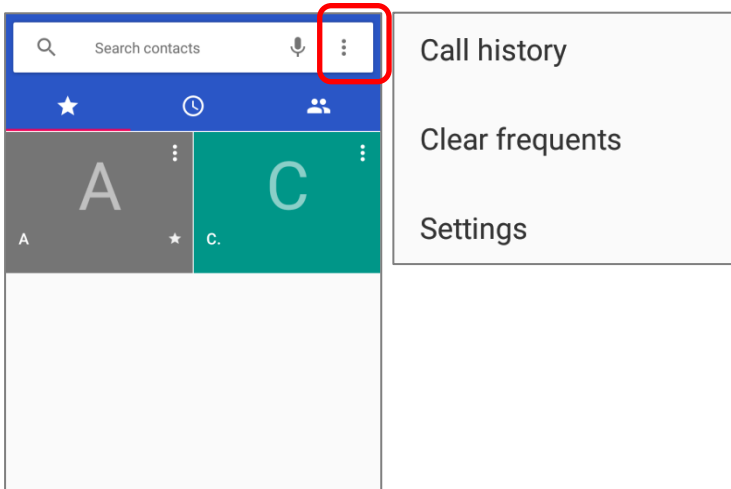

To clear the frequent calls, please tap  and select "**Clear frequents**".



## 5.2.2. PLACE CALL



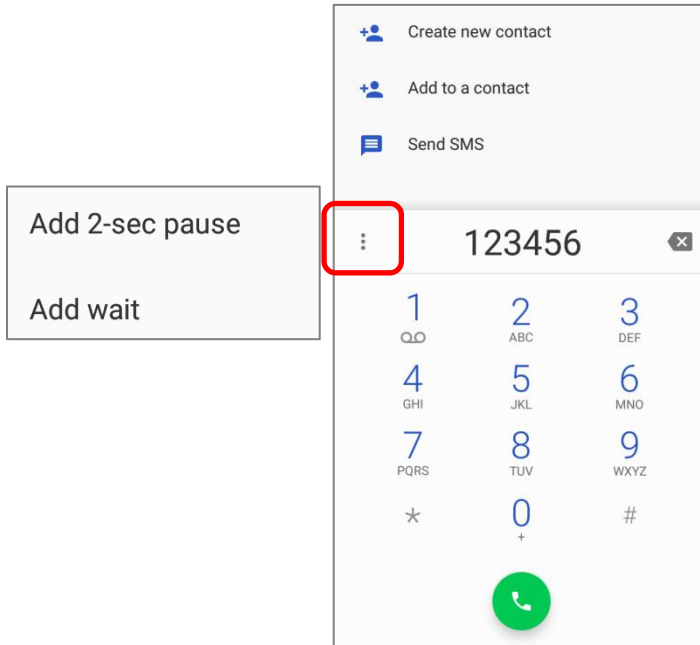

Tap  to expand the dial pad, and enter the phone number in the dial pad and tap  to initiate the call. If you need to frequently make calls to an interactive voice system, you may tap  next to the number and select **Add 2-sec pause** for soft pause (a pause of 2 seconds to the buttons) or a hard pause (a pause that will wait for your confirmation to send the following digits).

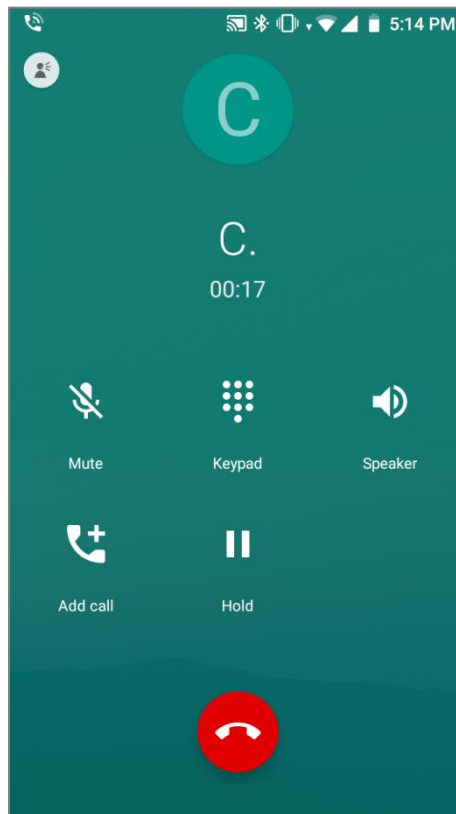

### 5.2.3. DURING A CALL

When a call is connected, the phone keypad features the following buttons:



Button	Description
	<b>Mute:</b> Mutes the call.
	<b>Keypad:</b> Opens the keypad.
	<b>Speaker:</b> Turns on the speaker.
	<b>Add call:</b> Adds another person to the call.
	<b>Hold:</b> Places the call on hold.

---

---

## PLACE CALL USING CONTACTS

To make a call using contacts:

- 1) In the phone application page, tap .
- 2) Tap a contact to initiate a call.

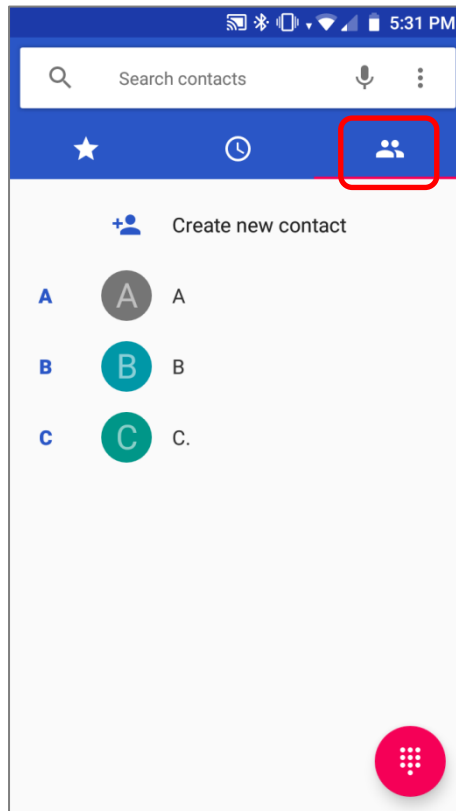

## 5.2.4. RECEIVE INCOMING CALL

When a call is incoming on the mobile computer, tap  to pick it up.

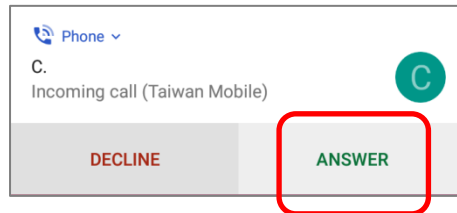

Incoming calls will be logged in the Phone application; in the case of a missed call, a notification will be displayed. See [Check Miss Calls](#).

To mute the ringtone of an incoming call, press the volume down button

## 5.2.5. CHECK MISSED CALLS

If you have a missed call, a notification icon  will appear on the status bar. The missed calls notification will also be displayed on:

1) The Phone app icon



2) The Lock Screen

(Turning on/off this function on:



[App Drawer \(All Apps\)](#) | **Settings**  | **Apps & notifications**  | **Notification** | **On the lock screen**)

Unlock the screen and use the [Notification Drawer](#) to manage the missed call.

## 5.2.6. CALL HISTORY

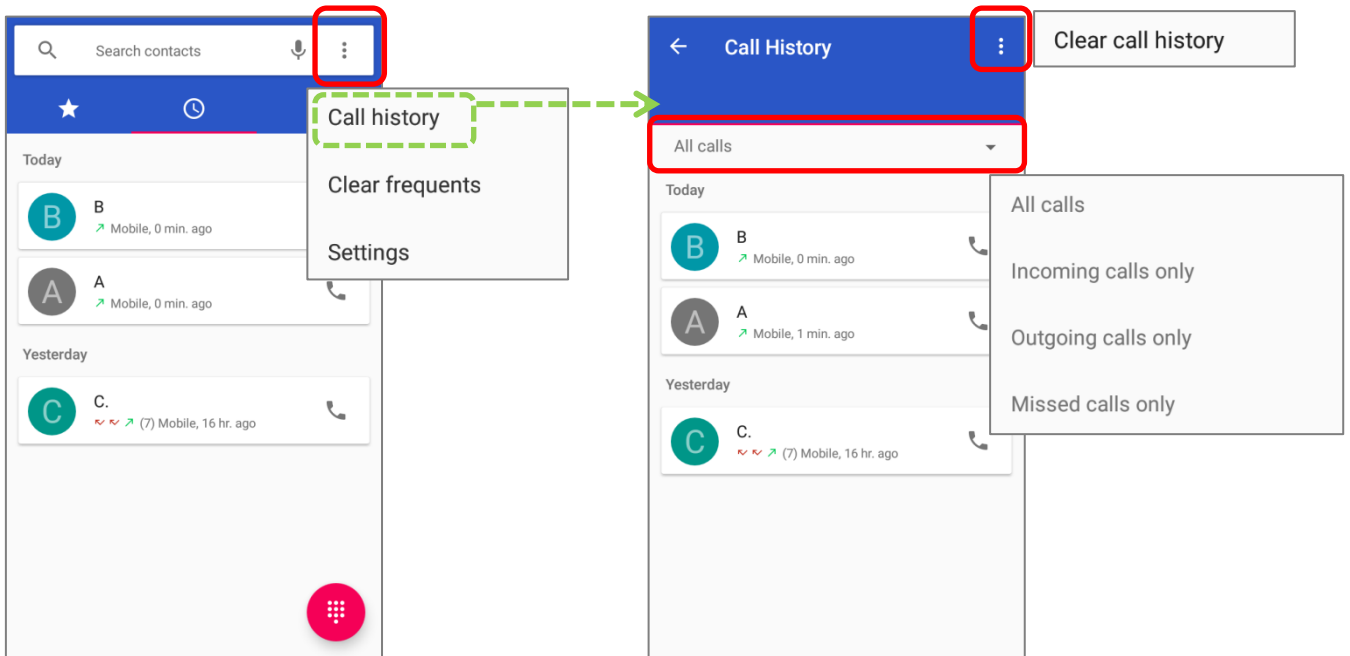
- 1) On the Phone application page, tap the **History** button  to open a list of history calls. Or you can tap the settings button  and then **Call History**.



Button	Description
	Connected calls.
	Missed calls.

- 2) Tap the phone icon  next to a call record to place back the call.



5.2.7. CALL SETTINGS

Tap  and select "**Settings**" to enter the settings page:

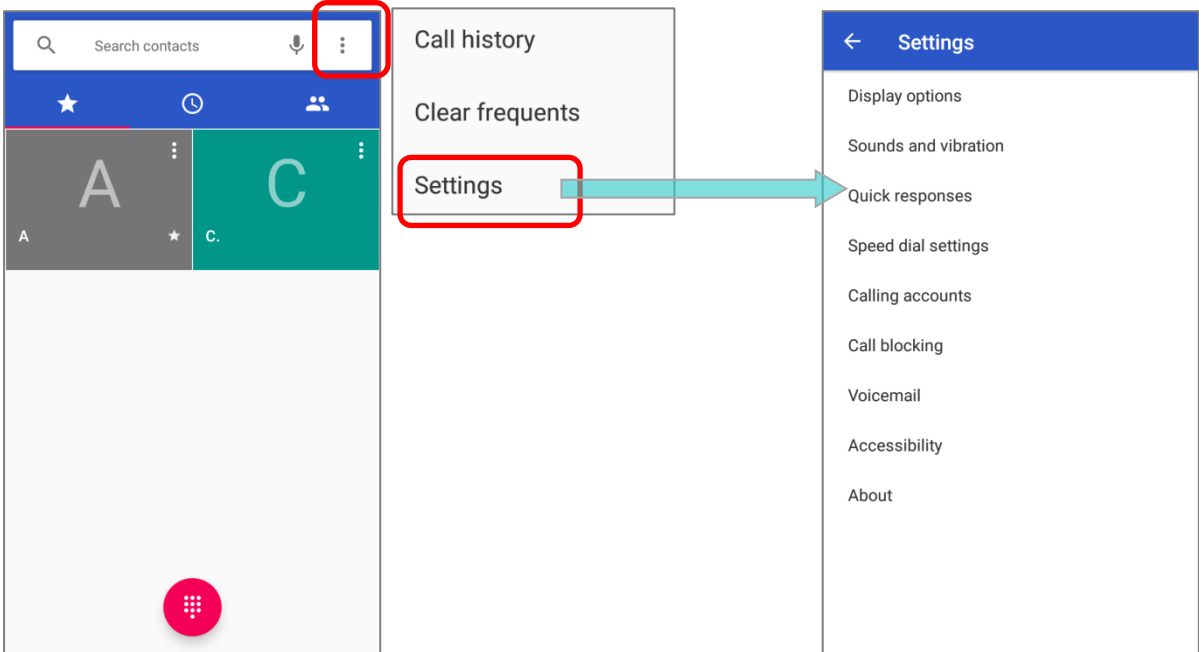









Tap each setting for more setting options.

---

---

## 5.2.8. MAKE MULTI-PARTY CALLS

To make multi-party conference calls:

- 1) On the Phone application page, enter the first number to call and tap  to initiate the call.
- 2) After the call has begun, tap  and then **Add call** to add another member. The first call will be put on hold.
- 3) Enter the second number to call and tap  to initiate the call.
- 4) When the second call is connected, the first call will continue to be on hold. Tap the merge call button  to add the first call to the conversation. A three-party conference call is initiated.
  - ▶ To add a fourth member, tap . The three-party call will be put on hold. Enter another number to call and tap  to initiate the call. When the call is connected, the three-party call will continue to be on hold. Tap the merge call button  to add the three-party call to the conversation. A four-party conference call is then initiated.
  - ▶ Tap **Manage Conference** to view all members of the call.
  - ▶ To remove a member, tap  next to the member.
  - ▶ To speak with a member in private, tap the member, and the conference call will be put on hold. Tap  to return back to the conference call.

### 5.3. AUDIO MODES

The mobile computer offers three different audio modes for phone calls:

#### HANDSET MODE

This is the default audio mode which uses the receiver above the touchscreen for audio output during calls.

#### SPEAKER MODE

This mode uses the built-in speaker for audio output during calls.

#### HEADSET MODE

Connect a Bluetooth headset or a wired headset to the mobile computer for audio output during calls.

#### USE BLUETOOTH HEADSET

See [Pair Bluetooth Devices](#) to connect the mobile computer to a Bluetooth device. The speaker phone becomes muted when a Bluetooth headset is connected.

#### USE WIRED HEADSET

Insert a wired headset depicted in the [Overview](#). The speaker phone becomes muted when a wired headset is connected.

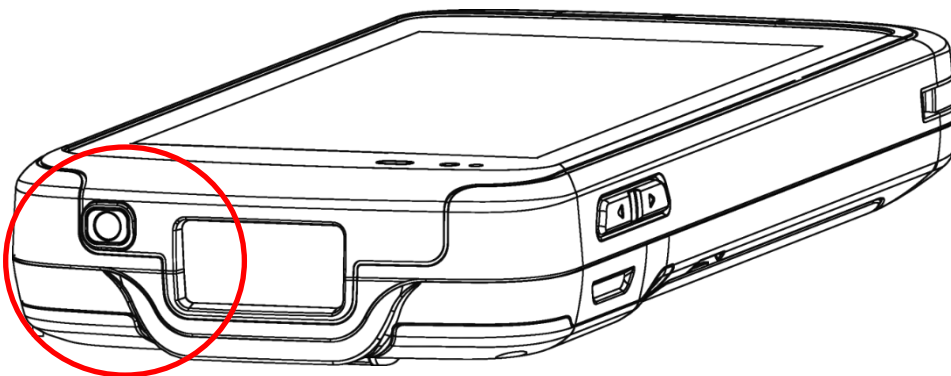

---

---

## 5.4. IN-CALL VOLUME

Use the volume buttons to adjust the ringer volume and system sound level. When in the middle of a call, use the volume buttons to adjust in-call conversation volume.

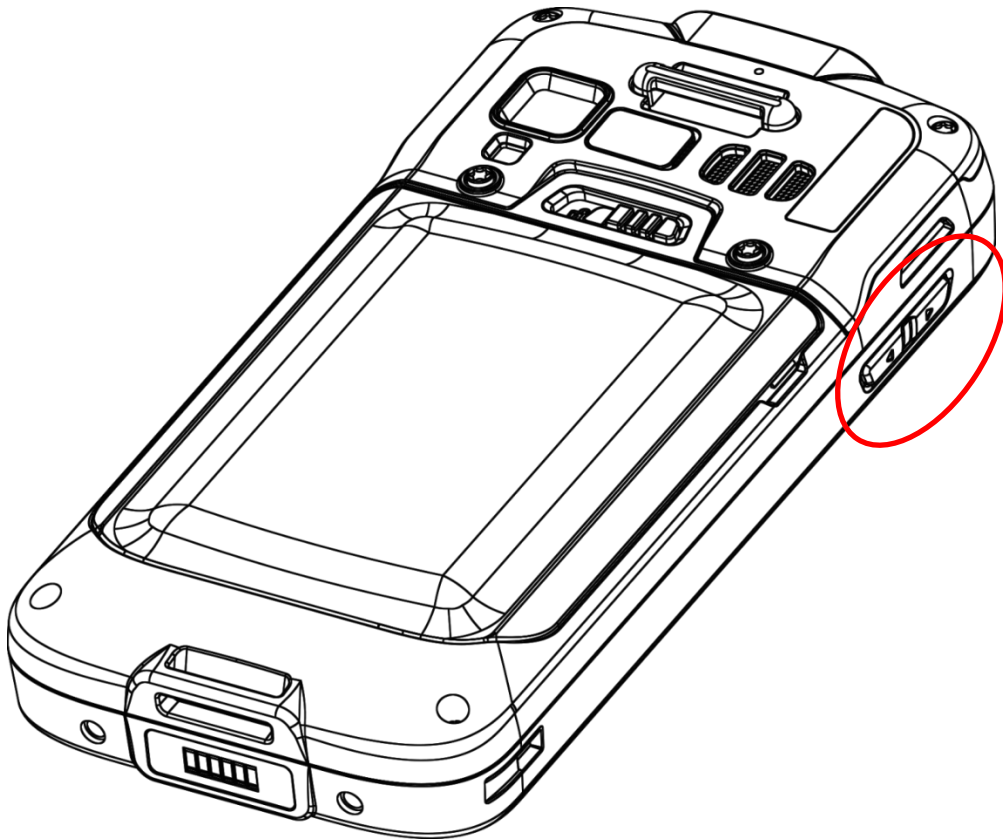

## Chapter 6

# USING READER CONFIGURATION UTILITY

---

The **Reader Configuration** utility allows you to manage the barcode reader integrated on the mobile computer.

### IN THIS CHAPTER

---

6.1 ReaderConfig Profile Managment .....	166
6.2 Configuring Reader .....	175
6.3 Read Printed Barcodes .....	187

## 6.1. READERCONFIG PROFILE MANAGEMENT

The mobile computer is capable of reading printed barcodes. The reader module can be either a (laser) 1D reader or a 2D imager. The mobile computer is installed with a **ReaderConfig** to configure the scan engine built inside. Use it to create a profile of settings that best suits your needs.

### LAUNCH READERCONFIG

To launch **ReaderConfig**, please go to [App Drawer \(All Apps\)](#) | **ReaderConfig**  to open the reader configuration utility.

The main screen of **ReaderConfig** consists of main menu and a list of profiles, including a “**Default**” profile which cannot be deleted. Next to each profile, there is also a profile menu which includes a set of operations that are specific to the profile.

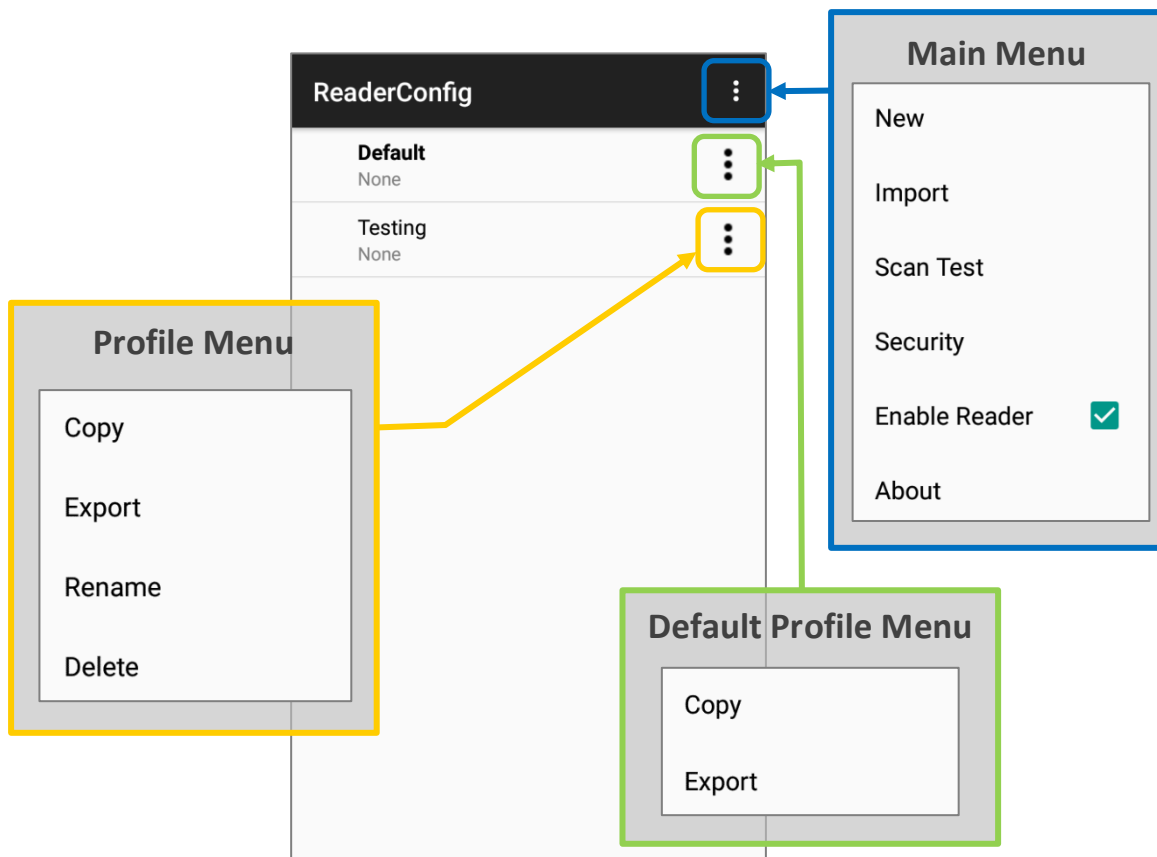

#### Note:

The “Default” profile is always enabled. Please refer to “[Profile](#)” for how to enable a profile.

### 6.1.1. READERCONFIG MAIN MENU

**ReaderConfig** provides an main menu which is accessible on the action bar of the main screen. This menu allows you to create new profiles, import profile(s) in a re-usable format, test scan barcodes, set a password for certain configurations of ReaderConfig, and view copyright and version information.

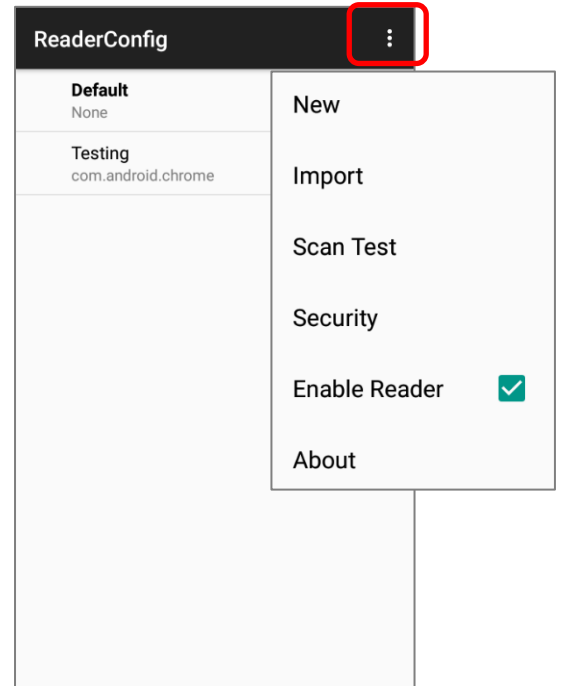

#### NEW

To create a new profile, please:

- 1) Tap the more button  on the action bar to display the main menu.
- 2) Tap **"New"** and enter a name for new profile in the pop-up dialog. Tap **"OK"** to create the profile.

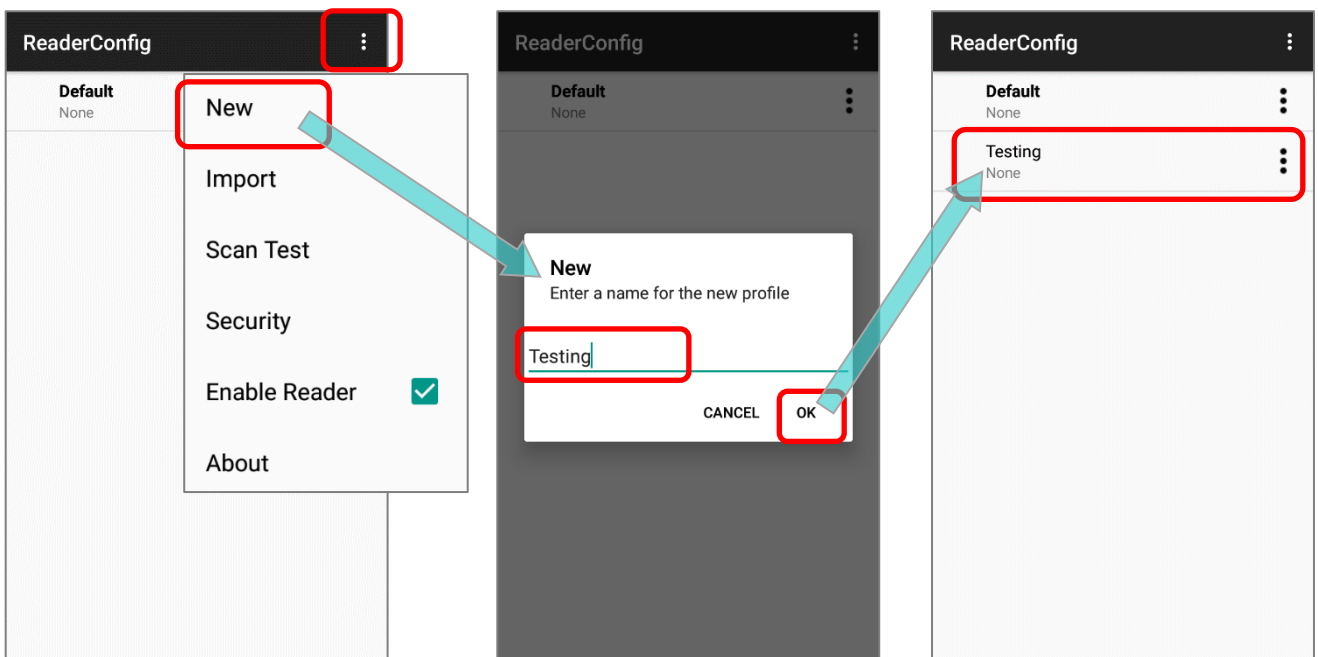

---

---

## IMPORT

**ReaderConfig** supports saving the profile settings and exporting them as a **.json** file.

Previously exported profile(s) can be imported again on the mobile computer. This can also be used to implement identical ReaderConfig settings on multiple devices.

To import settings:

1) Open **ReaderConfig** as described in [Launch ReaderConfig](#).

2) Tap the more button  on the action bar to open the main menu.

3) Tap **Import** in the option menu.

A page opens allowing you to select a previously saved profile.

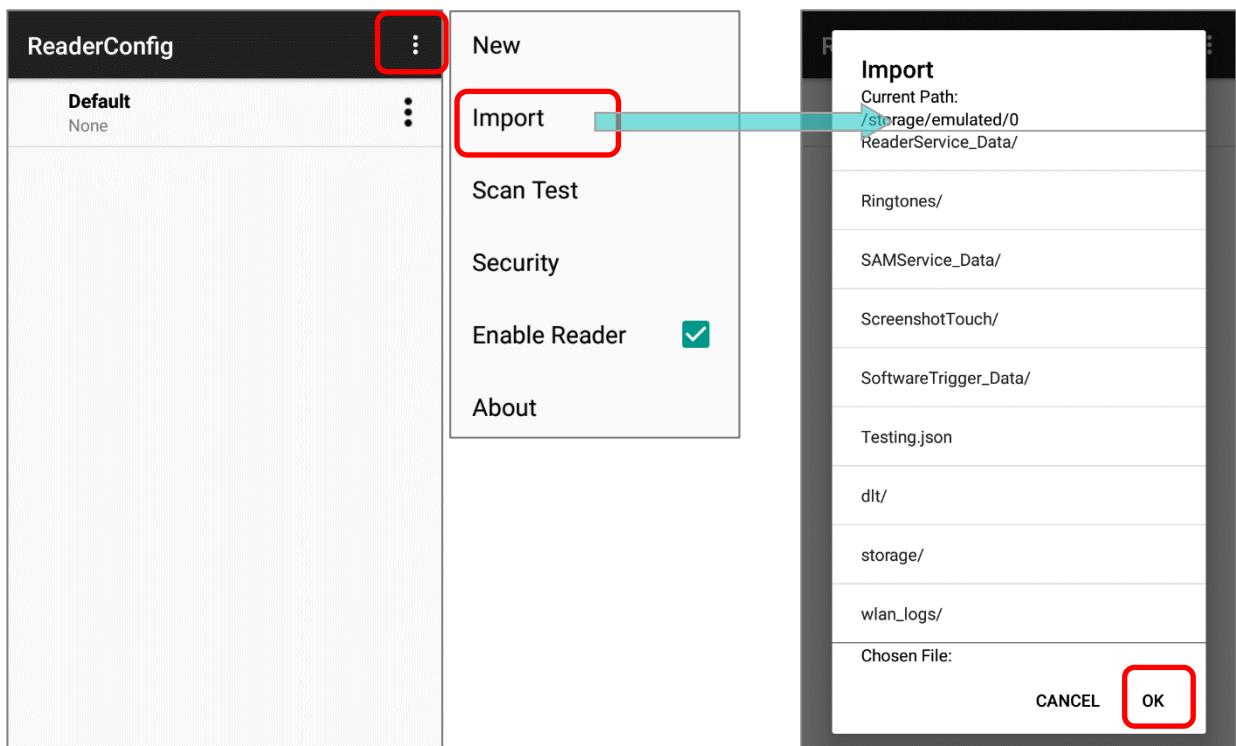

4) Tap **OK**. In a few seconds a prompt will appear on the mobile computer to indicate settings have been imported successfully.

---

---

### Note:

As to exporting a profile, please refer to "[Export](#)" of "Profile Menu".

---

---



When importing a profile that has the same name with an existing profile, a confirmation dialog appears to make sure whether you really want to replace existing profile with the one to be imported.

Tap on **OK** to proceed importing.

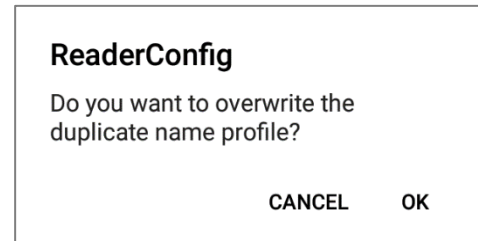

## SCAN TEST

To test scan a barcode:

- 1) Open **ReaderConfig** as described in [Launch ReaderConfig](#).
- 2) Tap the more button  on the action bar to open the option menu.
- 3) Tap **Scan Test** in the main menu. A page opens for test scanning.

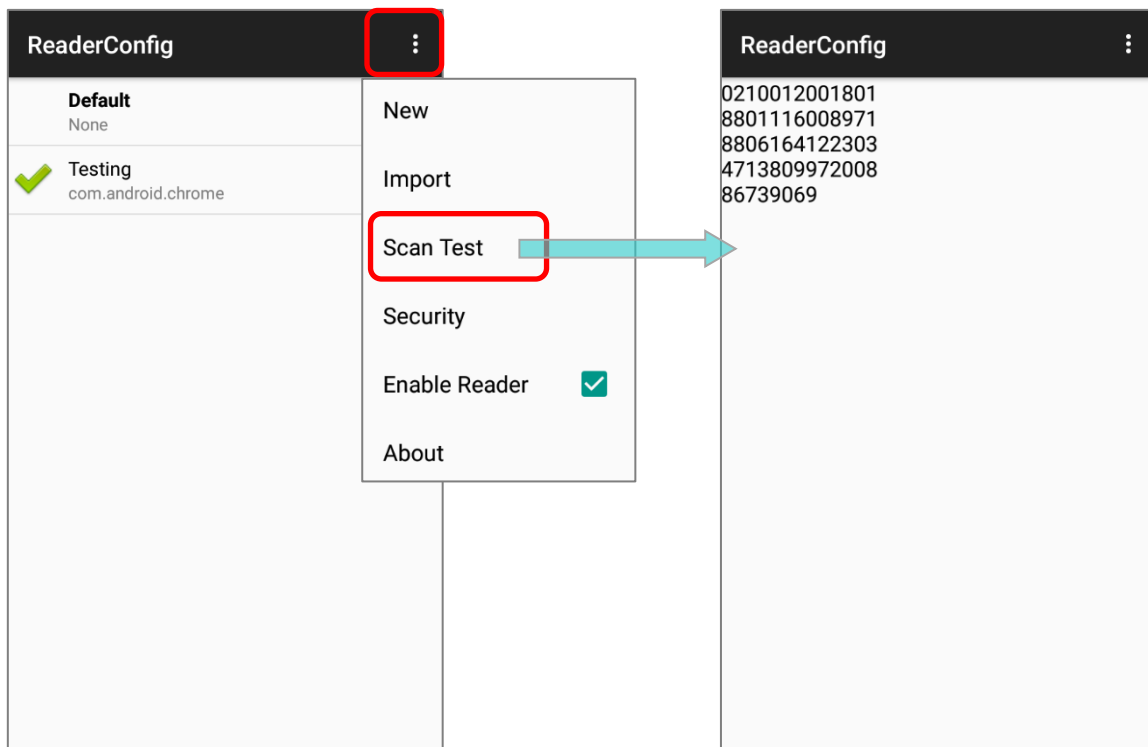

## SECURITY

You can set a password to restrict other users of this mobile computer from changing certain configurations or accessing certain functions in ReaderConfig.

- 1) Open **ReaderConfig** as described in [Launch ReaderConfig](#).
- 2) Tap the more button  on the action bar to open the option menu.
- 3) Tap **Security**.
- 4) Enter and confirm a password (up to 32 characters, containing at least 1 digit or 1 alphabetic letter).
- 5) Check the items that will be protected by this password.

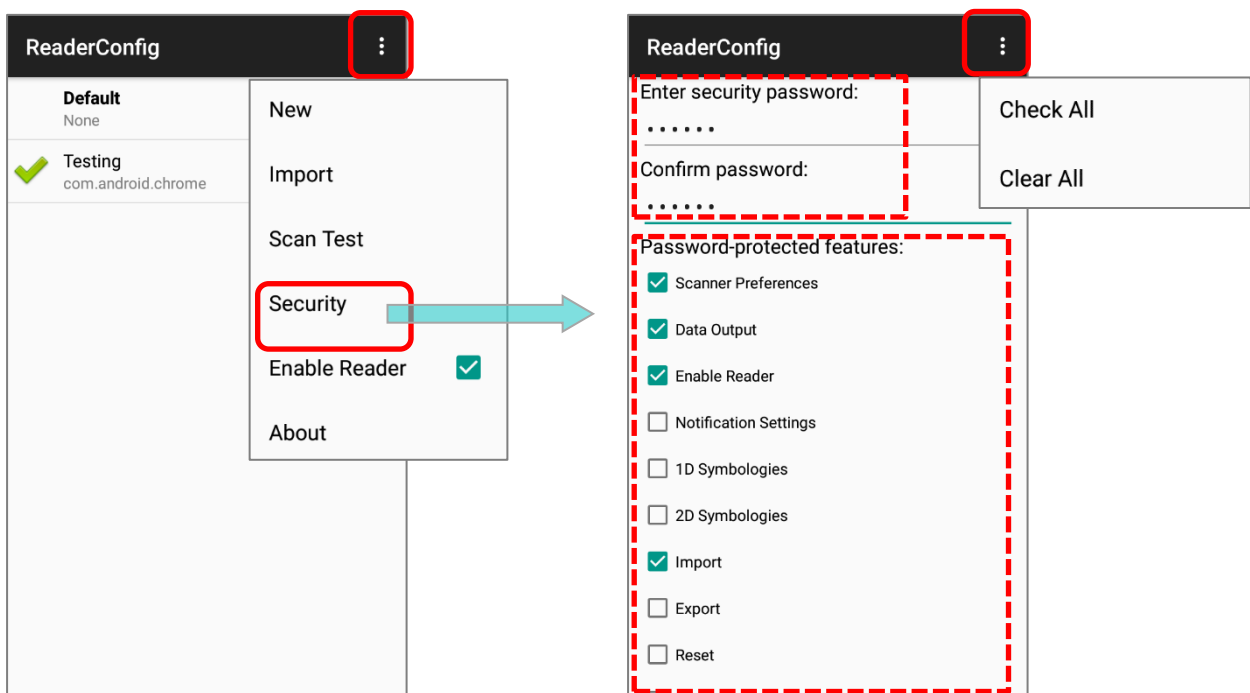

## ENABLE READER

Tick or untick the checkbox to enable or disable reader scanning ability. When enabled, a light beam will be sent out from the scanning window each time the trigger (scan key) is pressed.

By default, the reader is enabled.

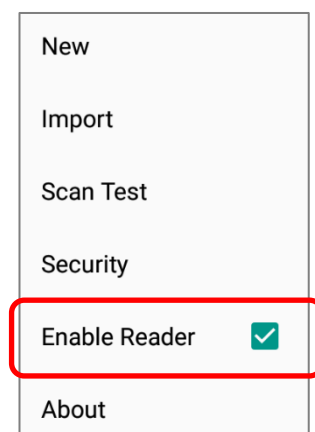

## ABOUT

Tap **About** in the **ReaderConfig** main menu to display software version and copyright information.

 **ReaderConfig**  
ReaderConfig 1.2.2  
Reader Service 1.2.87  
Reader Type SE4750SR  
Firmware IMGKIT\_8.01T01.2  
0\_02  
  
Copyright © CipherLab Co. Ltd.  
<http://www.cipherlab.com>  
  
OK

## 6.1.2. PROFILE MENU

Tap more button  on the right of the profile to display the profile menu. The profile menu contains options that are specific to the profile. The options are described in the followings sections:

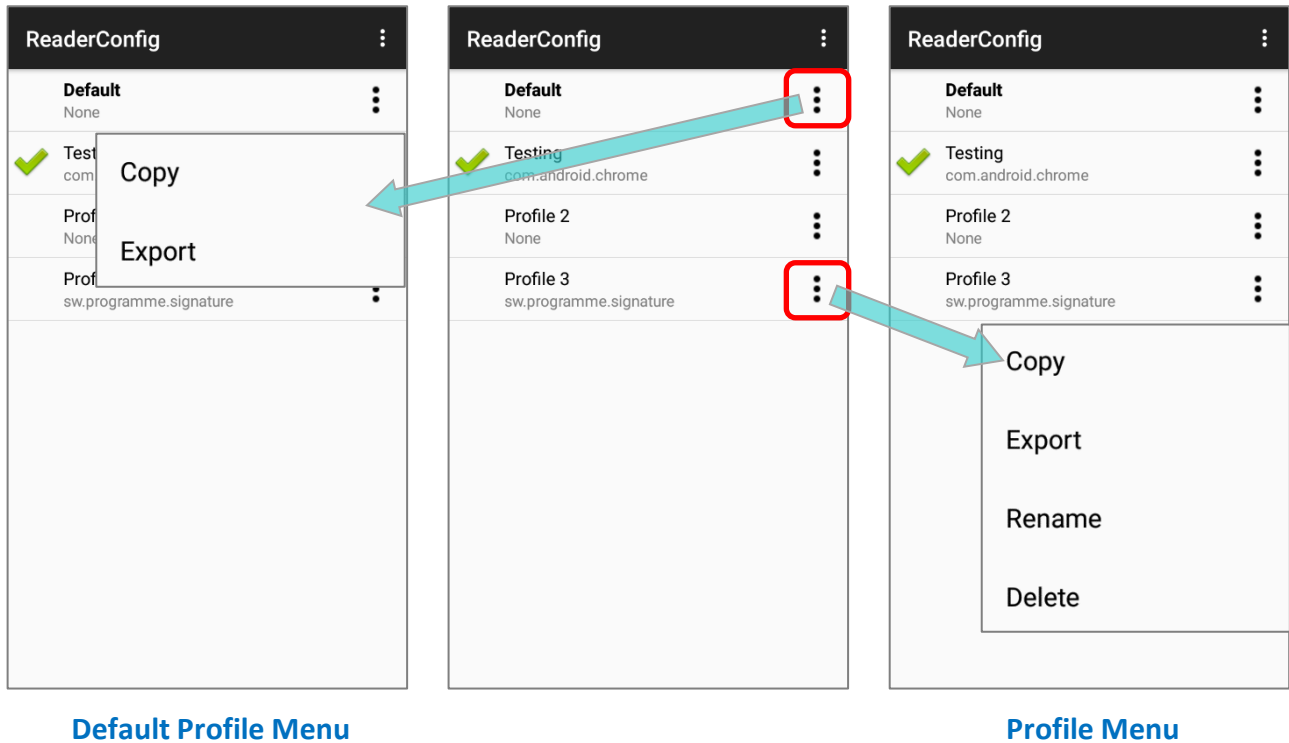

### COPY

You can copy an existing profile and make changes from it.  
To copy a profile:

- 1) Tap the more button  next to the profile you would like to copy, and select **"Copy"** from its profile menu.

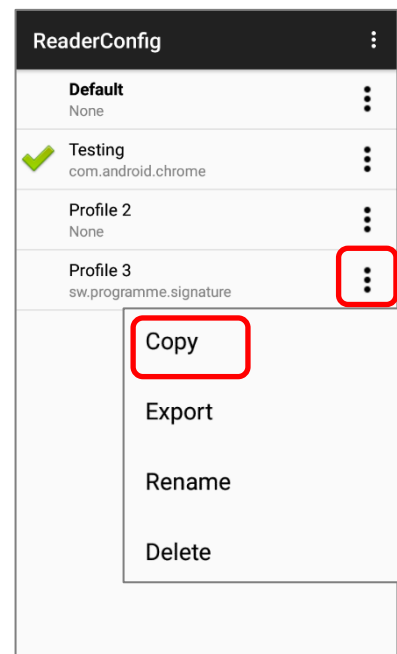

2) Enter a name for the new profile and press the "OK" button to make a copy.

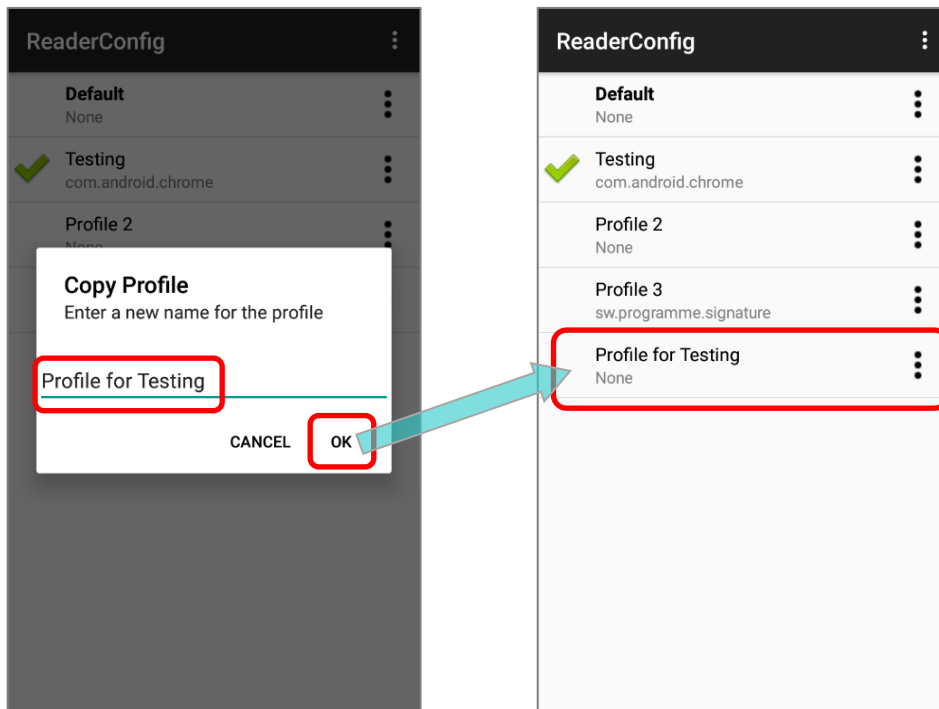

**Note:** An app can be set as the [associated app](#) to only one profile. Thus, [the "Profile" part](#) will not be duplicated when copying a profile.

## EXPORT

To export a profile, tap the more button  next to the profile that you would like to export and select "**Export**". An export page opens allowing you to enter the name and location of the profile to save.

Tap **OK** to export. A prompt will appear on-screen to notify that settings have been exported.

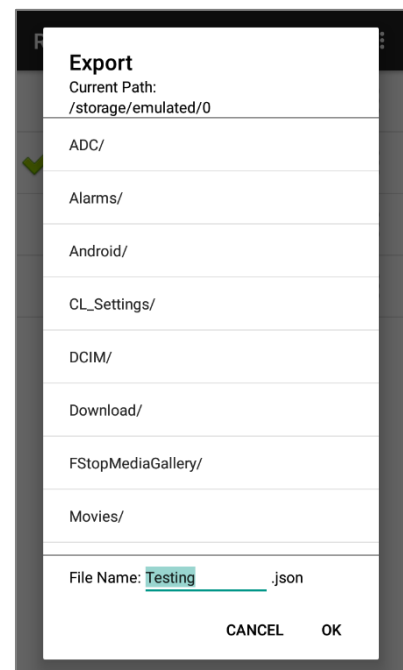

**Note:** The exporting profiles will be saved as a .json file.

## RENAME

To rename an existing profile, simply tap on the more button  next to the profile you'd like to rename and select "**Rename**". Then, enter a new name for the profile. Finally, tap "**OK**" button to change its name.

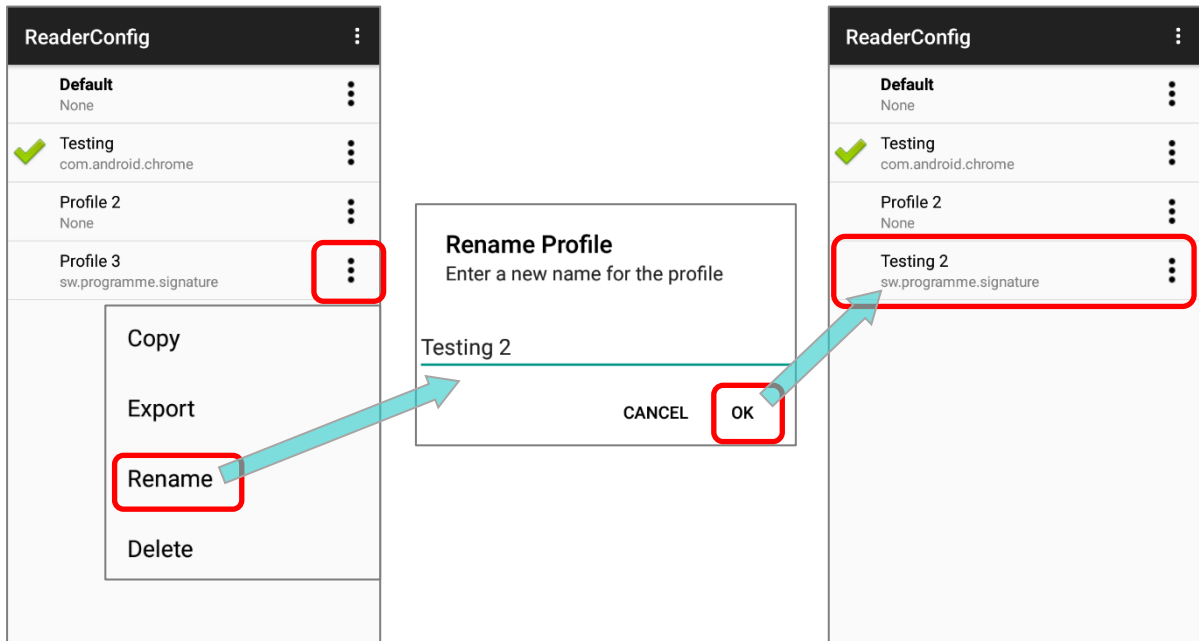

## DELETE

To delete a profile, simply tap on the more button  next to the profile you would like to delete and select "**Delete**". Tap "**OK**" on the confirmation dialog to delete the profile.

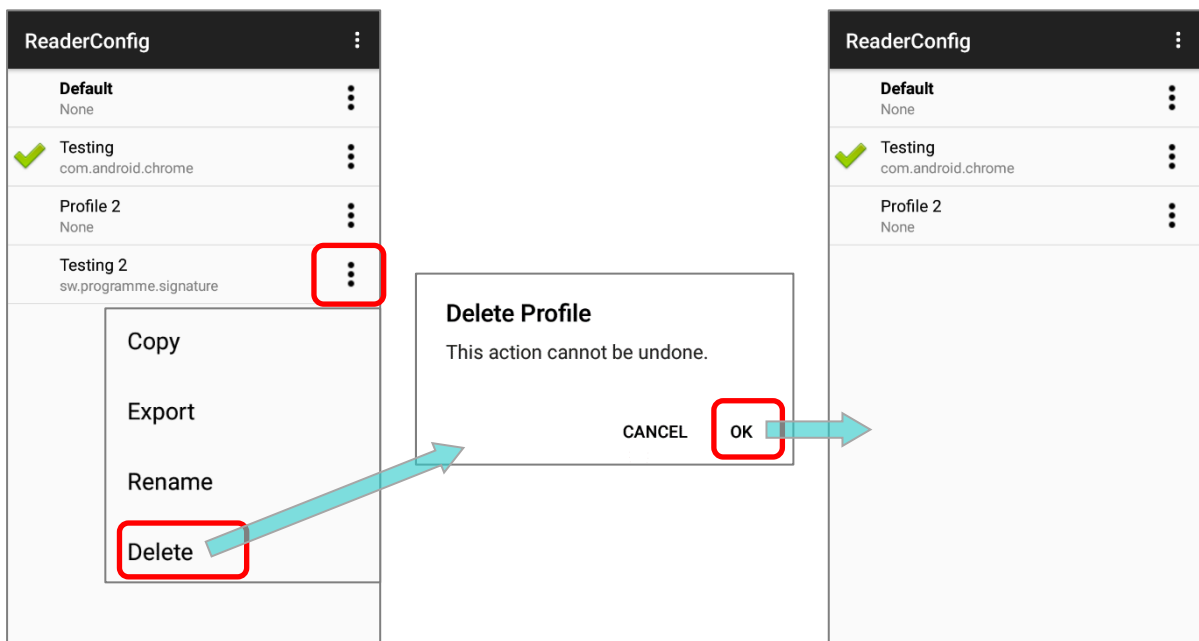

## 6.2. CONFIGURING READER

Tap on a profile to enter the profile main page for further settings.

### Default Profile Main Setting Page

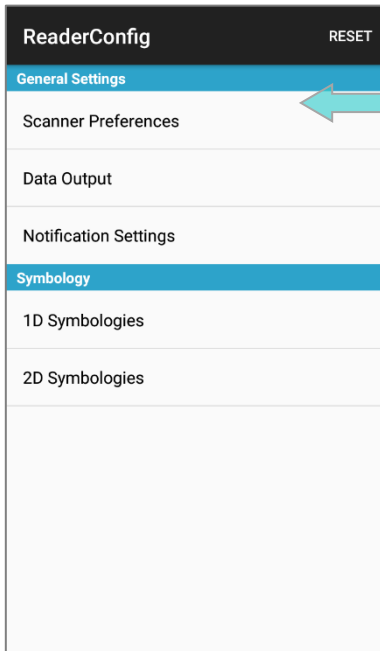

### ReaderConfig Main Screen

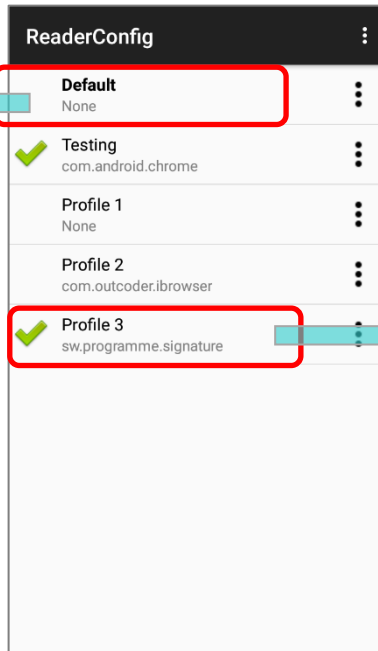

### Profile Main Setting Page

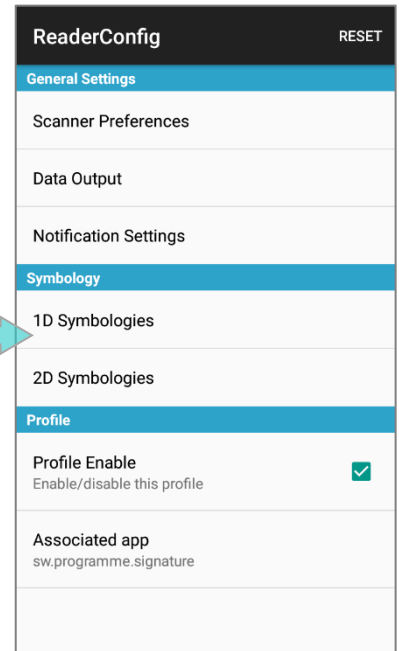

**ReaderConfig** launches in context with the reader module(s) on board the mobile computer. On the profile main settings page are three sections: **General Settings**, **Symbology** and **Profile**.

### 6.2.1. GENERAL SETTINGS

**General Settings** is where all reader settings are accessed from. Tap each item to enter its sub-menu.

The functions under **General Settings** include:

- ▶ Scanner Preferences
- ▶ Data Output
- ▶ Notification Settings

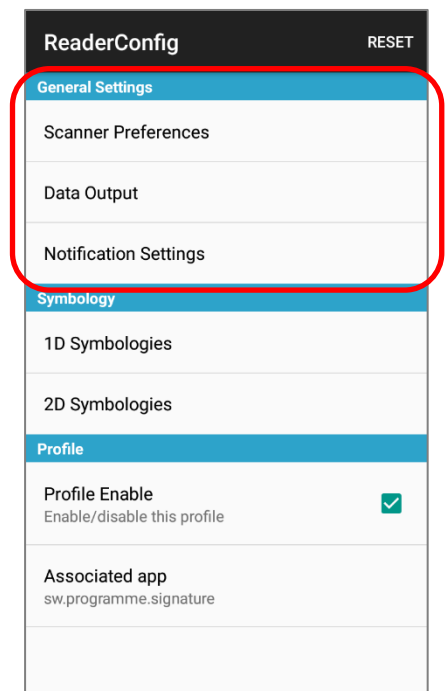

## SCANNER PREFERENCES

Options on the **Scanner Preferences** page differ according to the type of scan engine built within the mobile computer.

Simply tap on **Scanner Preferences** to open **Scanner Preferences** page:

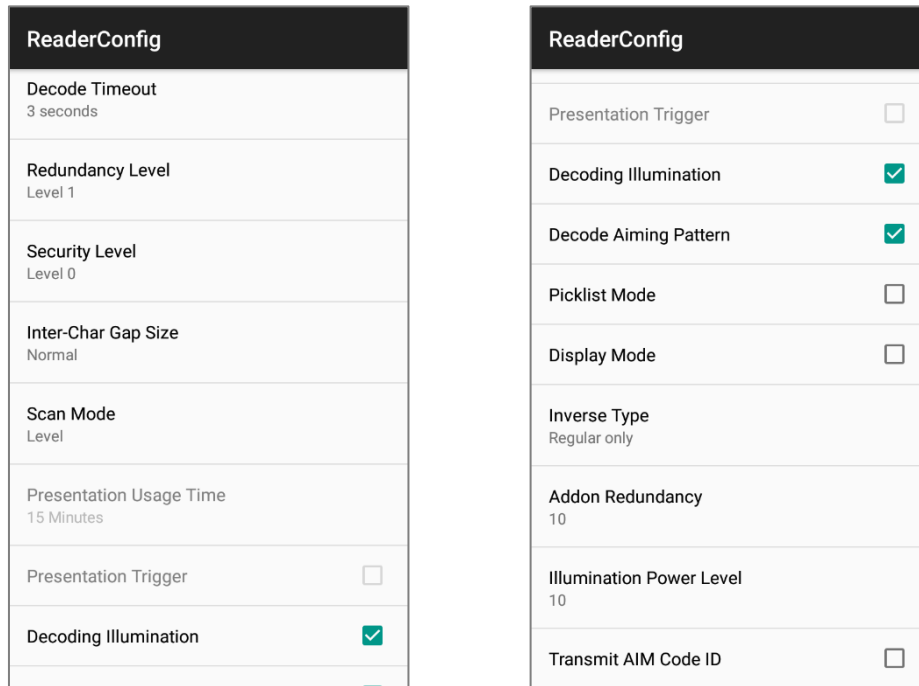

## 2D IMAGER SETTINGS

Setting	Description	Default										
Decode Timeout	Sets the maximum time for the decoding process during a scan. Configurable between 1 sec to 9 sec.	3 sec.										
Redundancy Level	Sets how many successful readings should be done before linear barcodes such as Codabar, MSI, and Interleaved 2 of 5 can be decoded. Levels 1 to 4 available.	Level 1										
Security Level	Sets the security level to ensure decoding accuracy considering the printed quality of barcodes such as Code 128, Code 93, and UPC/EAN. The higher the level is, the more security is ensured. Options are: <table border="1" data-bbox="375 1624 1257 2002"> <thead> <tr> <th>Level</th> <th>Description</th> </tr> </thead> <tbody> <tr> <td>0</td> <td>With this default, the scan engine is aggressive enough to decode most “in-spec” barcodes.</td> </tr> <tr> <td>1</td> <td>Select this level if misdecodes have occurred. It fixes most misdecodes.</td> </tr> <tr> <td>2</td> <td>Select this level if Level 1 should fail to eliminate misdecodes.</td> </tr> <tr> <td>3</td> <td>Select this level if Security Level 2 should fail to prevent misdecodes. However, as this level actually impairs the decoding ability of the decoder, a safer solution would be to improve the quality of the bar codes to read.</td> </tr> </tbody> </table>	Level	Description	0	With this default, the scan engine is aggressive enough to decode most “in-spec” barcodes.	1	Select this level if misdecodes have occurred. It fixes most misdecodes.	2	Select this level if Level 1 should fail to eliminate misdecodes.	3	Select this level if Security Level 2 should fail to prevent misdecodes. However, as this level actually impairs the decoding ability of the decoder, a safer solution would be to improve the quality of the bar codes to read.	Level 0
Level	Description											
0	With this default, the scan engine is aggressive enough to decode most “in-spec” barcodes.											
1	Select this level if misdecodes have occurred. It fixes most misdecodes.											
2	Select this level if Level 1 should fail to eliminate misdecodes.											
3	Select this level if Security Level 2 should fail to prevent misdecodes. However, as this level actually impairs the decoding ability of the decoder, a safer solution would be to improve the quality of the bar codes to read.											



Setting	Description	Default
Inter-Char Gap Size	Sets the intercharacter gap size for Code 39 and Codabar. This option is to allow the digital scanner to adjust its decoding standard so as to tolerate out-of-specification bar codes that are improperly printed out (which may cause the intercharacter size to become larger). Switch between <b>Normal</b> and <b>Large</b> .	Normal
Scan Mode	Sets the reader's scanning behavior. <b>Level:</b> The decoding process is activated by a trigger event, and continues until the trigger event ends, a valid decode happens or decode session time-out is reached.	Level
Decoding Illumination	Enables an LED light beam to aid barcode reading.	Selected (Enabled)
Decode Aiming Pattern	Projects a crosshair at the center of the laser light beam to facilitate barcode reading.	Selected (Enabled)
Picklist Mode	When selected, only barcodes aligned at the crosshair of the laser light beam will be decoded.	Deselected (Disabled)
Display Mode	Enable improved performance for reading barcodes on electronic displays and mobile phones.	Deselected (Disabled)
Inverse Type	Decide whether to disable or enable decoding inverse barcodes, or set as auto.	Regular only
Addon Redundancy	Functions when "auto-discriminate" is applied for UPC/EAN addons. Decides the number of times of supplemental decoding of the same barcode in order to count as a valid read. Configurable between 2 and 30.	10
Illumination Power Level	Users can adjust the illumination brightness of the LED light source. Move the slider to specify a value ranging from 1 to 10 to set the brightness level which is set to 10 by default meaning 100% illuminated.	10
Transmit Code ID	Sets whether to include AIM code ID character in the decoded data. For AIM code ID, see the following: <a href="#">Code 128 Emulation</a> of 2D Imager <a href="#">Symbology Settings</a> .	Deselected (Disabled)

## DATA OUTPUT

**Data Output** allows users to set the way to output decoded data.

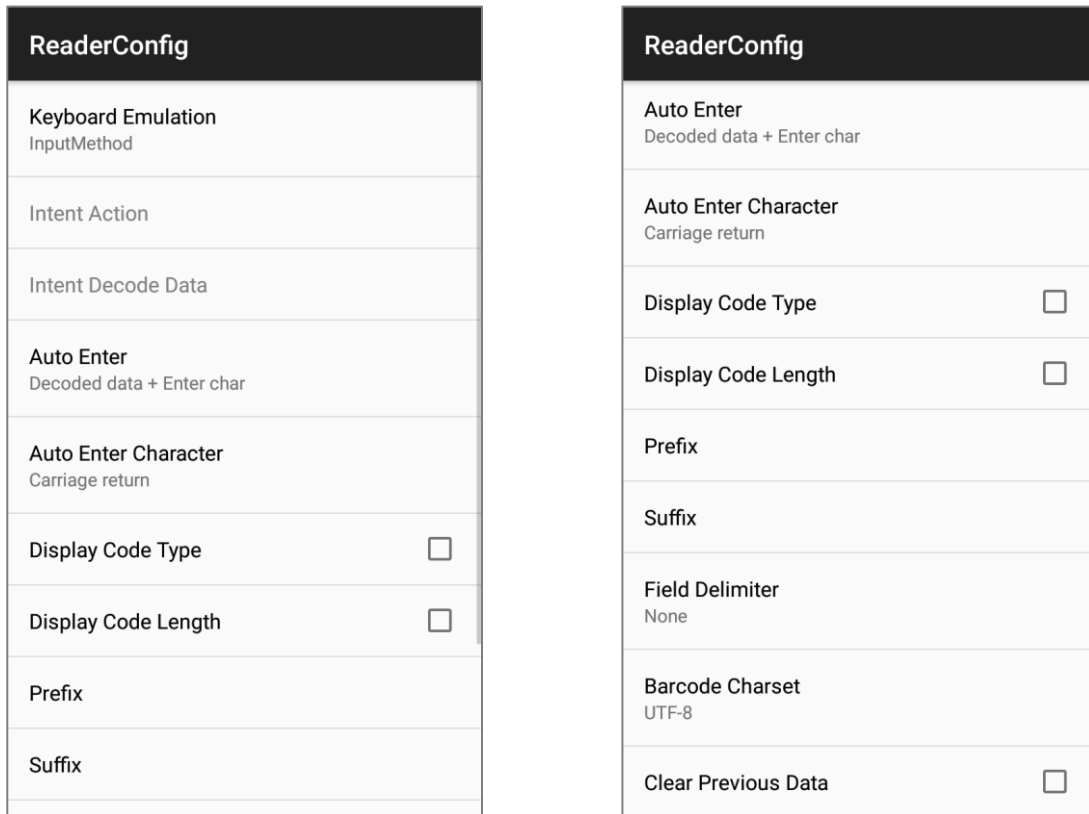

## DATA OUTPUT METHOD

**Keyboard Emulation** setting controls in which way the data is sent.

Setting	Descriptions	Default
Keyboard Emulation	<p>Tap the switch to enable. When enabled, the reader module treats decoded data as typed text and outputs it to the active application on the mobile computer. Options are:</p> <ul style="list-style-type: none"> <li>▶ <b>None:</b> Disables keyboard emulation. The decoded data will be sent by the broadcast intent message.</li> <li>▶ <b>InputMethod:</b> Allows the active application to receive characters or symbols that can be input by the input method.</li> <li>▶ <b>KeyEvent:</b> Allows the active application to receive characters or symbols that can be input by key events.</li> </ul>	InputMethod

**HOW TO OUTPUT**

After determining the keyboard emulation type, please configure how to output decoded data, i.e. the "format" to present decoded data.

Setting	Description	Default
Auto Enter	<p>Adds an ENTER character before or after each string of decoded data. The ENTER character can be defined in the "Auto Enter character" field below. This function saves the trouble of pressing a confirmation key to accept each string of decoded data. Options are:</p> <ul style="list-style-type: none"> <li>▶ Disable</li> <li>▶ Decoded data + Enter char</li> <li>▶ Enter char + Decoded data</li> </ul>	Decoded data + Enter char
Auto Enter character	<p>Adds a key code before or after the decoded data. If [Auto Enter] is enabled, select the ENTER character to send. Options are:</p> <ul style="list-style-type: none"> <li>▶ None</li> <li>▶ Carriage Return</li> <li>▶ Tab</li> <li>▶ Space</li> <li>▶ Comma</li> <li>▶ Semicolon</li> </ul>	Carriage Return
Display Code Type	Prefixes the output data with code type information.	Deselected (Disabled)
Display Code Length	Suffixes the output data with code length information.	Deselected (Disabled)
Prefix	<p>Affixes 0 to 20 characters to the left of the output data. Tap the label to open a character table for entering the prefix.</p> <ul style="list-style-type: none"> <li>▶ Prefixes containing invisible characters are supported.</li> </ul>	--
Suffix	<p>Affixes 0 to 20 characters to the right of the output data. Tap the label to open a character table for entering the suffix.</p> <ul style="list-style-type: none"> <li>▶ Suffixes containing invisible characters are supported.</li> </ul>	--
Field Delimiter	<p>Sets the delimiter to separate the output barcode data to the following pieces: code type, decoded barcode data, and code length (if applicable). Options are:</p> <ul style="list-style-type: none"> <li>▶ None</li> <li>▶ Comma</li> <li>▶ Semicolon</li> <li>▶ Full stop</li> </ul>	None
Barcode charset	Specifies the current decoding for barcode data.	Windows-1252:Western European
Clear Previous Data	By enabling this option, only the last scanned data entry will be output.	Deselected (Disabled)

**NOTIFICATION SETTINGS**

**Notification Settings** enables audible, visible and tactile feedback for scanning good read, which helps notify the user of a successful decoding.

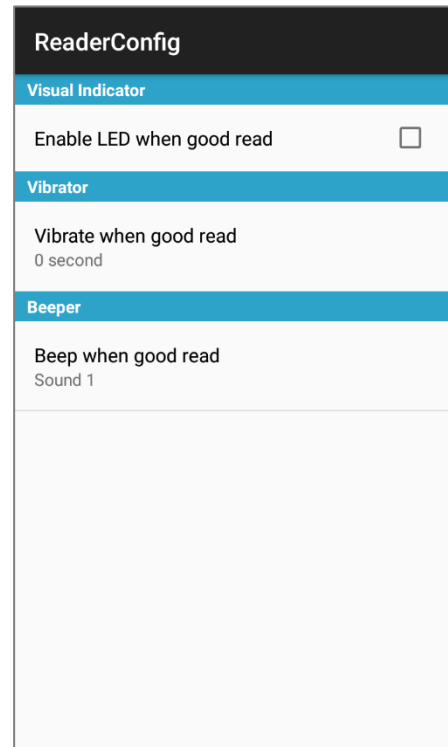

Setting		Description	Default
LED	Enable LED when good read	Selects to enable/disable LED light (left) for scanning good read. See <a href="#">Status LED</a> for details.	Deselected (Disabled)
Vibrator	Vibrate when good read	Enables/disables tactile feedback (vibration) for good read and sets the duration to vibrate.	0 second (Disabled)
Beeper	Beep when good read	Sets the beeper sound for scanning good read. Users can choose to mute the beeper sound, or configure the beeper between sounds 1 to 9.	Sound 1

## 6.2.2. SYMBOLOGY

The **Symbology** page sets the symbologies to read, and also enables/disables some feature(s) for a symbology to read, such as:

- ▶ Customize and transmit start/stop characters
- ▶ Verify/transmit check digits
- ▶ Enable/disable addon digits
- ▶ Convert to another symbology
- ▶ Transmit symbology ID

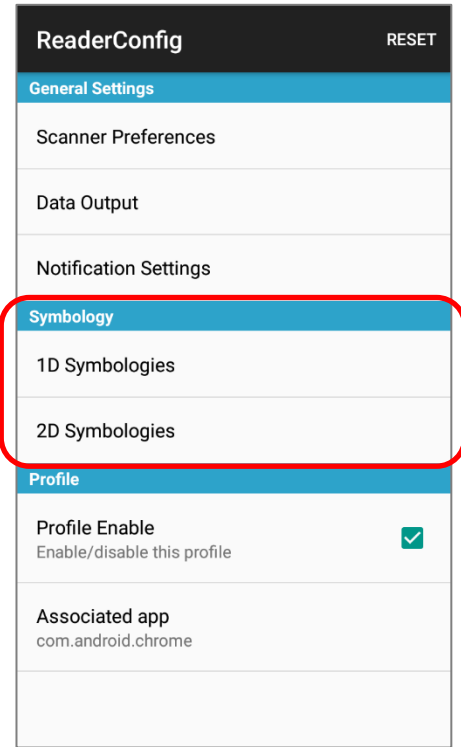

To open **Symbology** settings page, simply tap **1D Symbologies** or **2D Symbologies** (in case of a 2D imager) to list all symbologies which can be decoded.

### 1D Symbologies

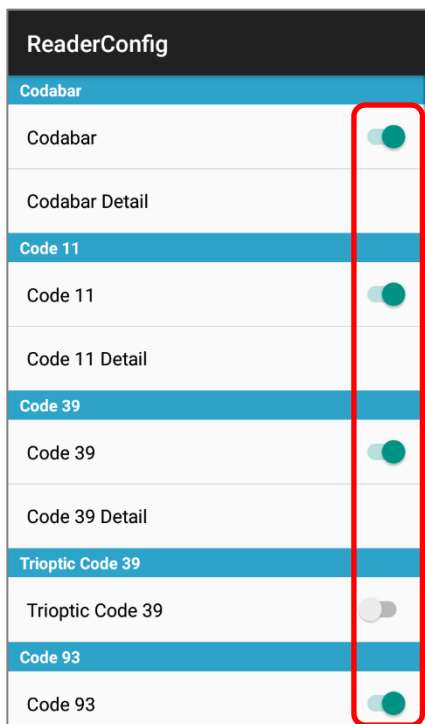

### 2D Symbologies

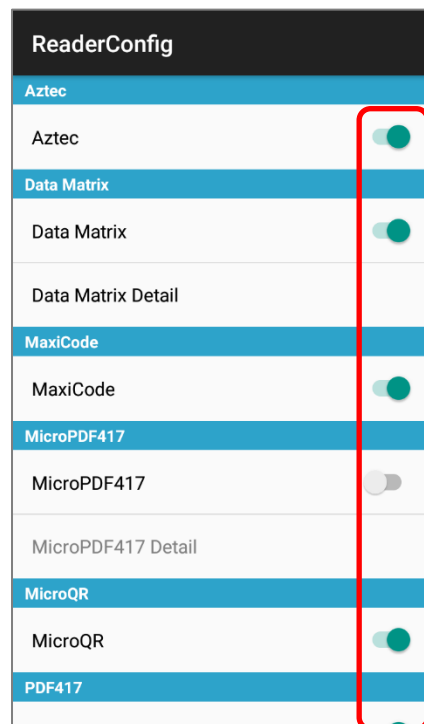

---

## ENABLE/DISABLE SYMBOLOGY

Tap the label of each symbology to enable or disable it.

---

## SYMBOLOGY SETTINGS

Tap the **Detail** label below each symbology to access detailed settings for the specific symbology.

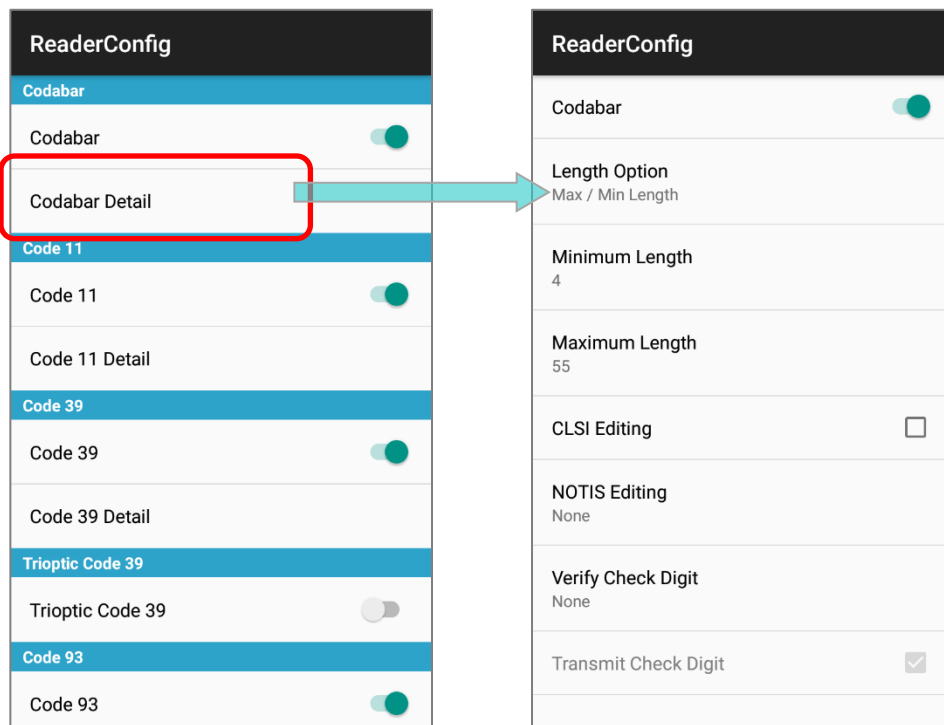

For details about the featured settings:

- ▶ See 2D Imager [Symbology Settings](#).

### 6.2.3. PROFILE

With an **“Associated app”**, the profile can be enabled, and the **“Associated app”** will receive the decoded data output by **ReaderConfig** once the profile is enabled.

#### Note:

- (1) The **“Default”** profile doesn’t support **“Associated app”**, please assign **“Associated app”** to the profile(s) you create.
- (2) Multiple profiles can be enabled at the same time.

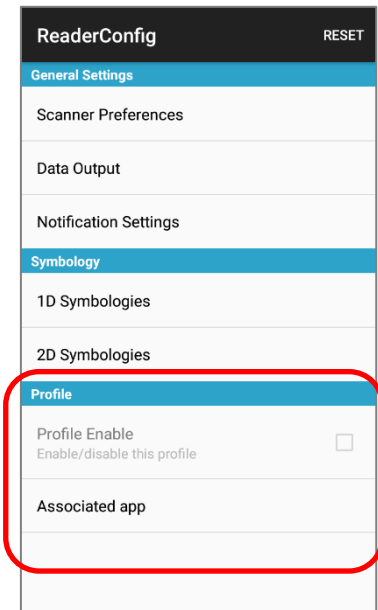

#### PROFILE ENABLE

To enable a profile:

- 1) Tap on the profile you’d like to enable to enter the profile main page.
- 2) Tap on **“Associated app”** under **“Profile”** to assign an app to be the **“Associated app”** to this profile.
- 3) Now the function **“Profile Enable”** is available for user to tick the checkbox to enable this profile.

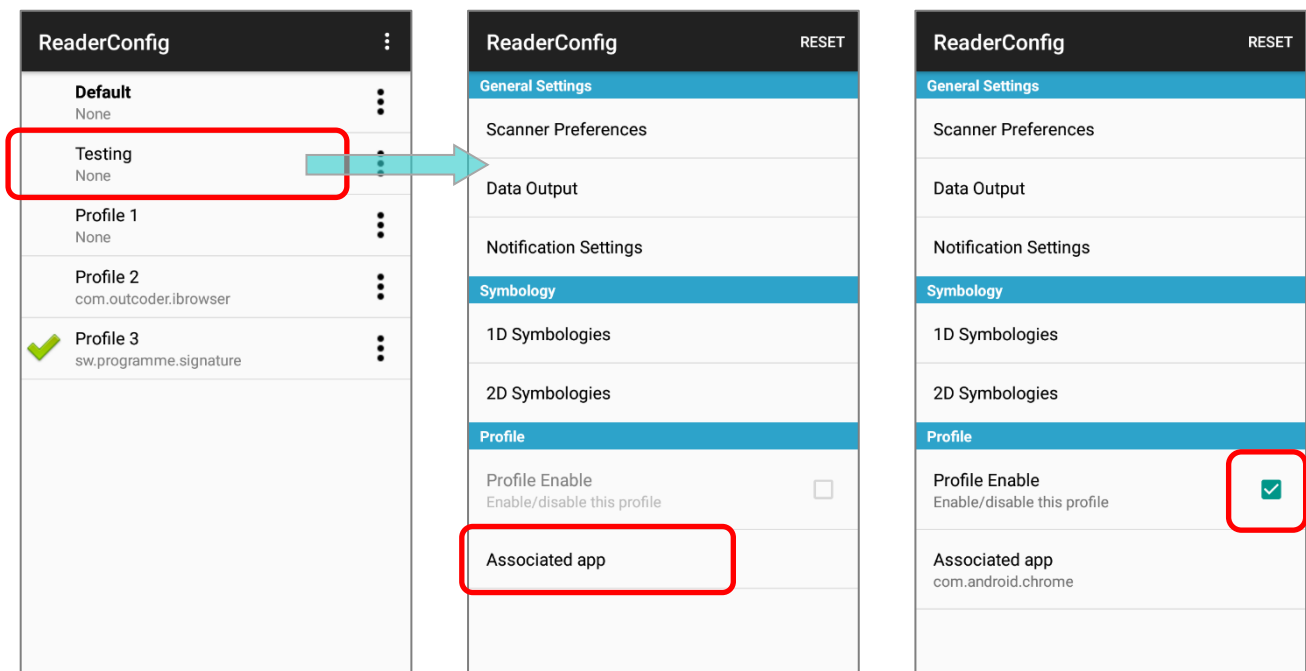

Return to **ReaderConfig** main screen, and you will find that the enabled profile(s) is with a check mark  next to it.

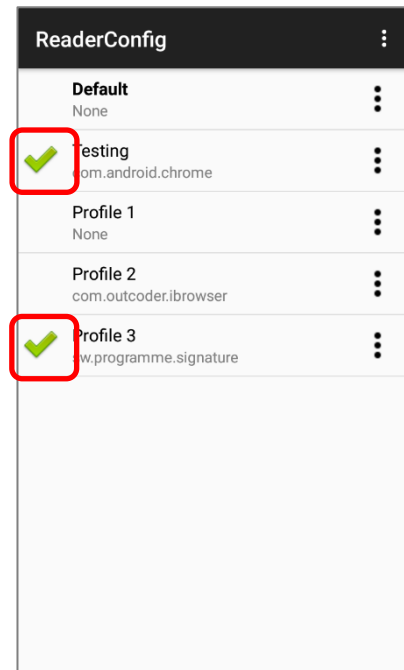

**Note:** Multiple profiles can be enabled at the same time.

#### ASSOCIATED APP

To assign an app as the "**Associated app**" to a profile:

- 1) Enter the profile main page and tap on ap on "**Associated app**" under "**Profile**".
- 2) Select the app to be the "**Associated app**" of this profile.

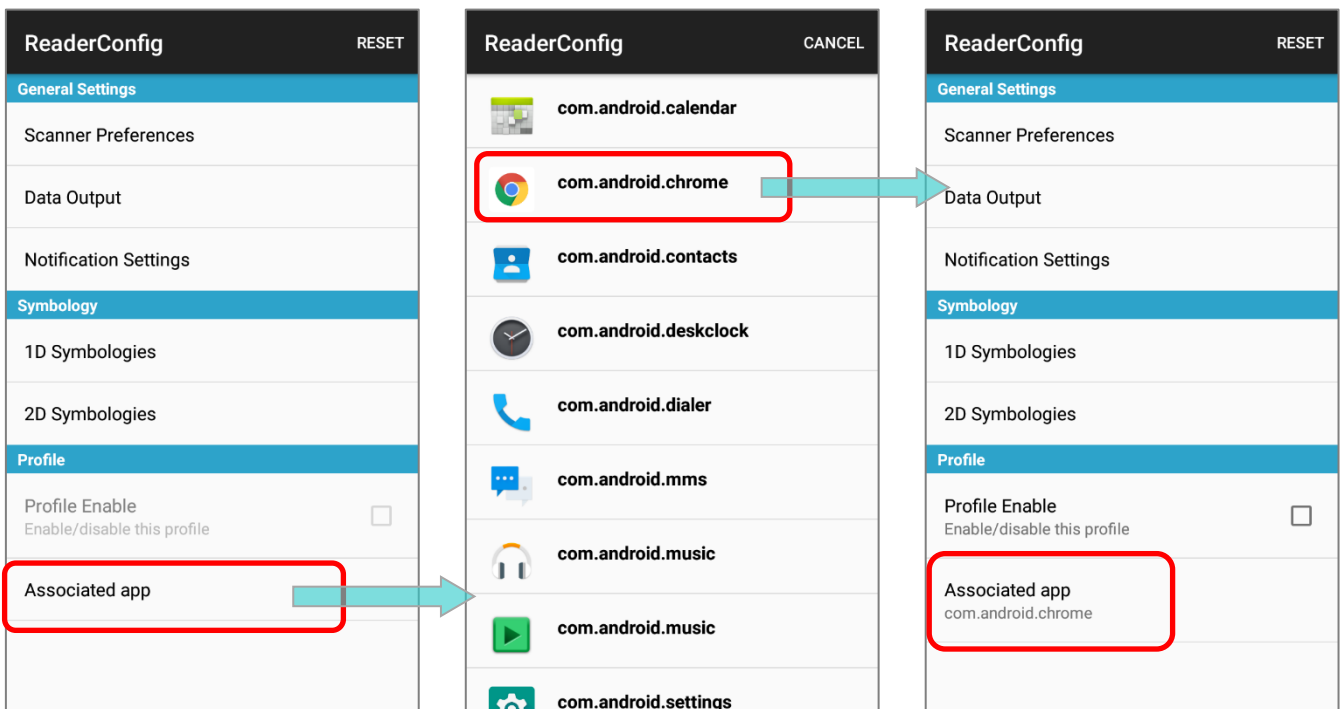



An app can be set as the associated app to only one profile. If the app you would like to select is already assigned to other profile, a prompt appears to remind you about this app is occupied by which profile.

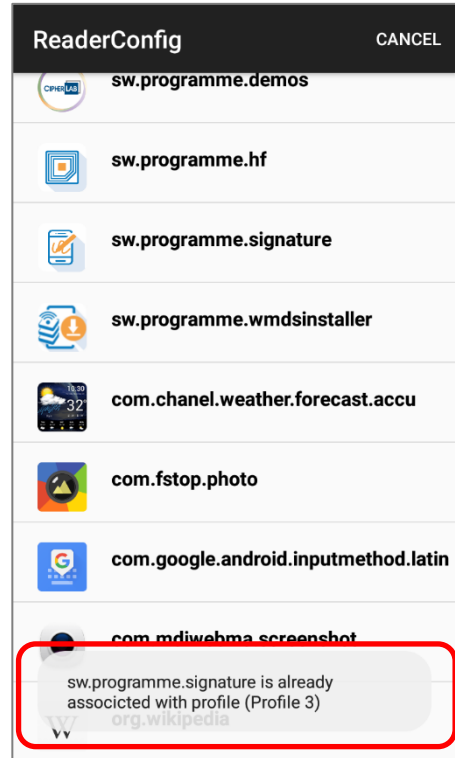

If a profile is enabled, its **“Associated app”** will receive the decoded data output by **ReaderConfig**.

- 1) Launch the **“Associated app”** of the enabled profile.
- 2) Aim the scan window at the barcode and press the side trigger to read it.
- 3) The decoded data is sent to the **“Associated app”**.

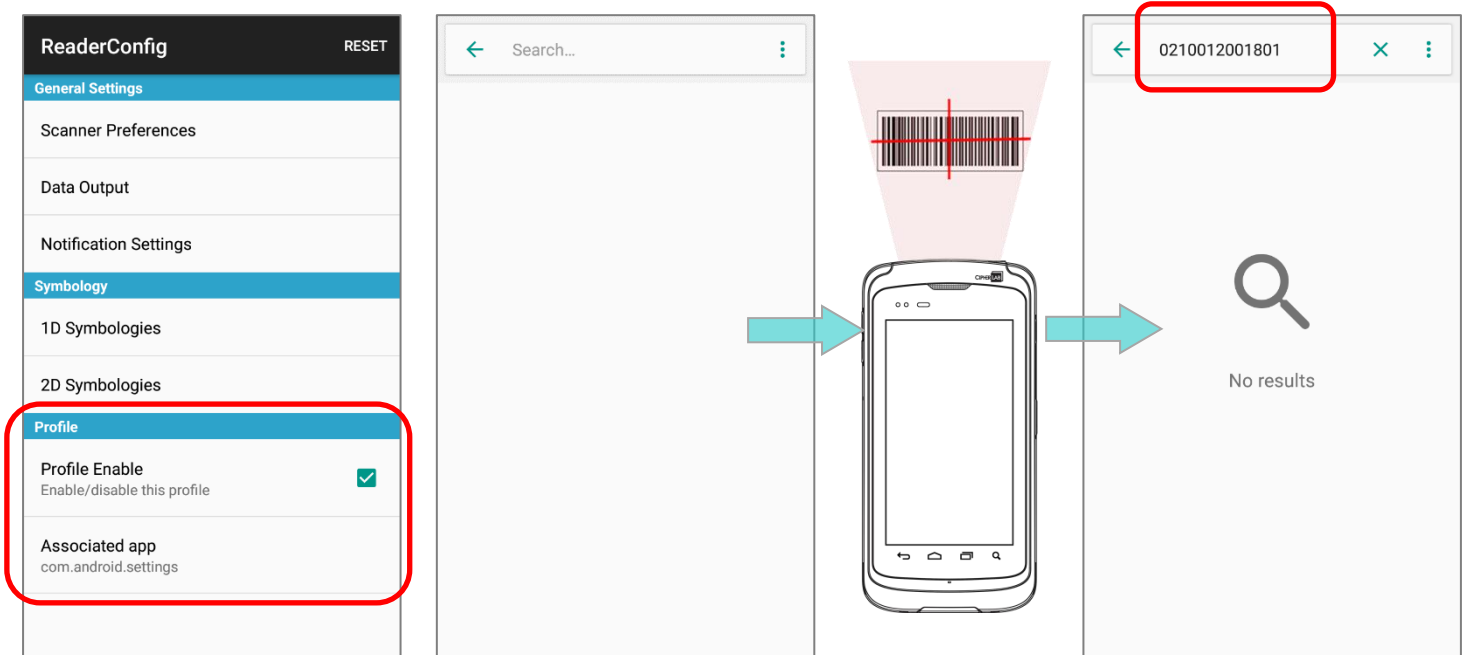

## 6.2.4. RESET

This function restores all settings in a profile to default.

To enable **Reset**:

- 1) Enter the profile main page of the profile you'd like to reset its settings.
- 2) Tap on "**RESET**" on the action bar.
- 3) Tap on "**OK**" on the confirmation dialog to reset or **Cancel** to close the dialog.

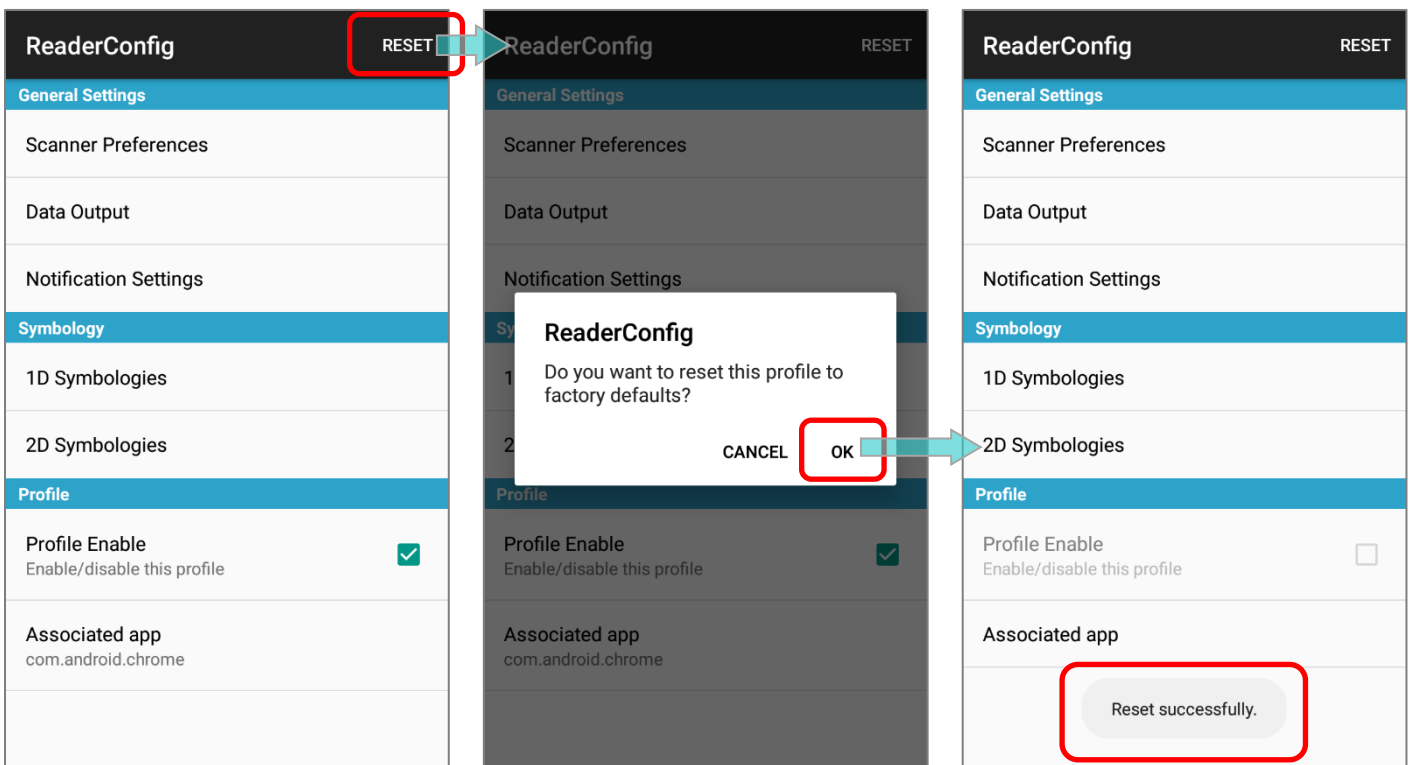

### 6.3. READ PRINTED BARCODES

Aside from output to destinations as per [Keyboard Emulation](#) settings, **ReaderConfig** provides a **Scan Test** feature for quick viewing of decoded data.

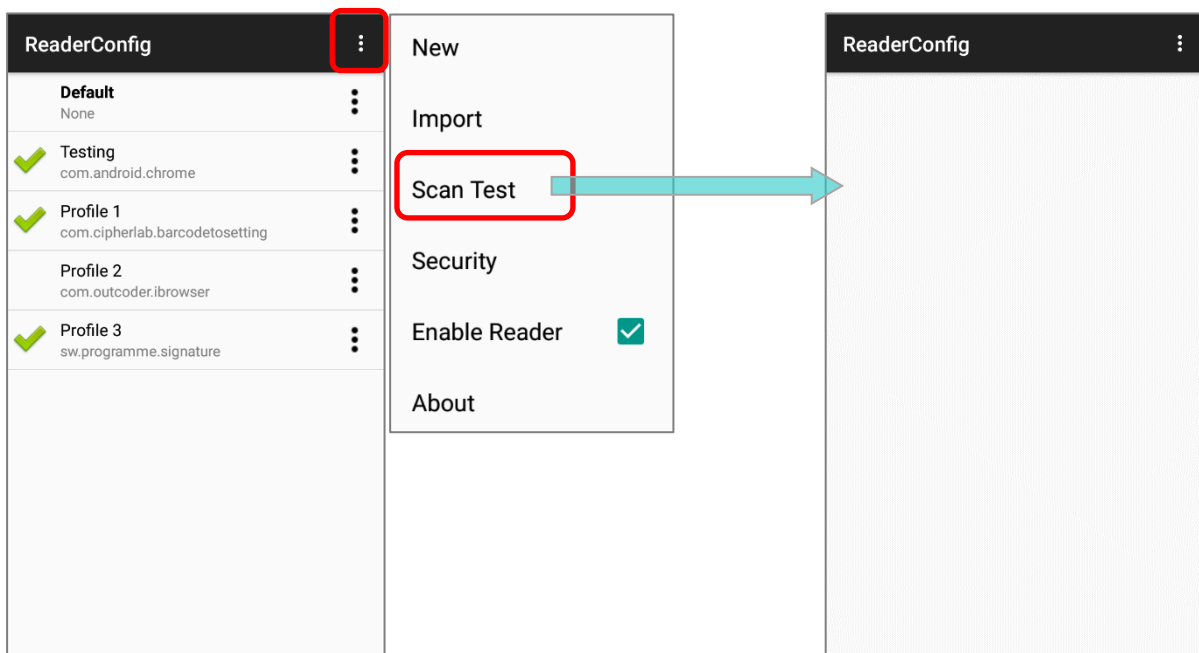

To perform test scanning of barcodes:

- 1) Open **ReaderConfig** as described in [Launch ReaderConfig](#).
- 2) On **ReaderConfig** main screen, tap the more button  on the action bar to open the main menu.
- 3) Tap on **Scan Test**. A Test Scan Form opens for displaying the scanned data.

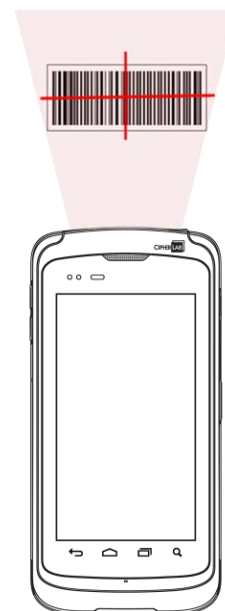

- 4) Aim the scanning window at the barcode to read and press any of the side trigger. The scanning light beams to read the printed barcodes. The scanning light goes off once the data is decoded, or when the decode timeout period has passed.



The decoded data will appear on the page. When finished viewing, tap  to leave the test scan page; or tap the more button  and then "**Save**" to save the decoded data as a .txt file, or "**Clear All**" to clear all data on the screen.

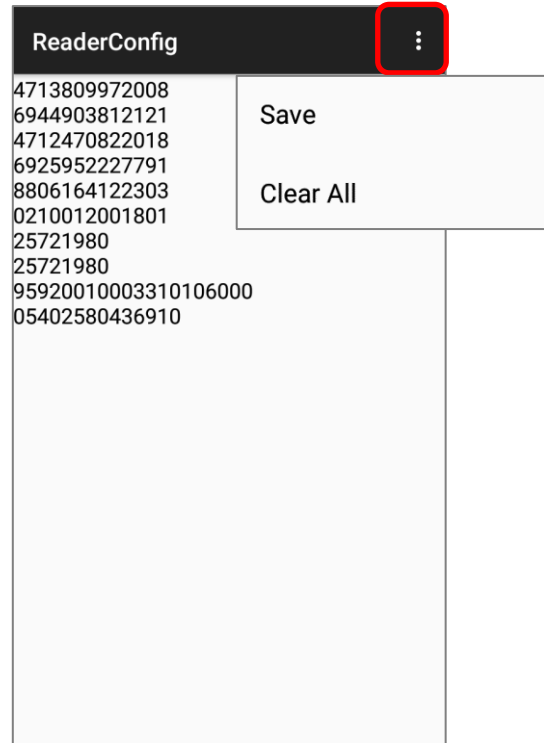
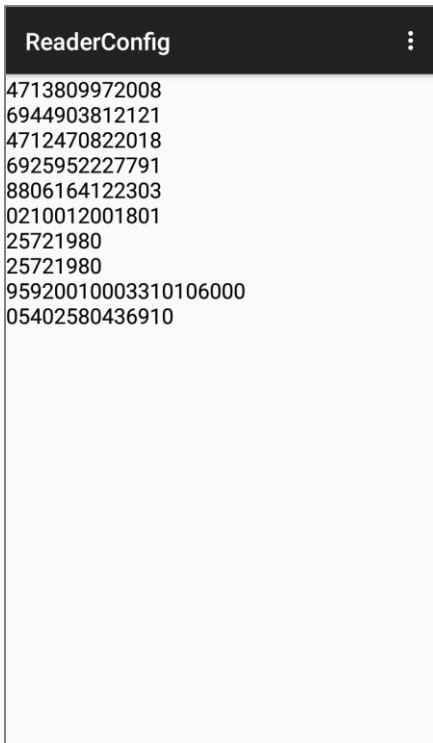

# SPECIFICATIONS

---

## PLATFORM, PROCESSOR & MEMORY

### Operating System & CPU

---

OS Version	Android 8.1 Oreo with GMS Certified
CPU	Qcta-core 1.8GHz

### Memory

---

ROM	16GB
RAM	2GB
Expansion Slot	One Micro SD card slot (up to 32GB for SDHC; up to 64GB for SDXC)

## COMMUNICATION & DATA CAPTURE

### Communication

USB Client	USB 2.0 OTG
WPAN	Bluetooth Class II, v4.1 and v2.1+EDR (2402~2480 MHz: 3.3dBm)
WLAN	802.11 b/g/n and 802.11 a/ac/n networking (2412~2472 MHz: 18.34dBm 5180~5240MHz: 21.06dBm, 5260~5320MHz: 21.46dBm, 5500~5700MHz: 21.90dBm, 5745~5825MHz: 14.30dBm <b>(USA only)</b> ) Operations in the 5.15-5.35GHz band are retracted to indoor usage only.
WWAN	Built-in WWAN modem for Quadband GSM, UMTS, LTE functions: GSM/GPRS/EDGE/WCDMA/UMTS/HSDPA/HSUPA/HSPA+/LTE Worldwide Frequency bands: GSM/GPRS/EDGE 880~915, 925~960MHz: 29dBm 1710~1785, 1805~1880MHz: 30dBm WCDMA/UMTS/HSDPA/HSUPA:B1,B8 1922.4~1977, 2112.4~2167.6: 24dBm 880~915, 925~960: 24dBm LTE B1, B3, B7, B8, B20, B28, B38, B40 1922.4~1977, 2112.4~2167.6MHz: 23dBm 1710~1785, 1805~1880MHz: 23dBm 2500~2570, 2620~2690MHz: 23dBm 880~915, 925~960MHz: 23dBm 832~862, 791~821MHz: 23dBm 718~748, 758~773: 23dBm 2570~2620MHz: 23dBm 2300~2399.9MHz: 23dBm Americas GSM : 850/1900 UMTS : B2,B4,B5 CDMA : BC0, BC1, BC10 LTE : B2,B4,B5,B7,B12,B13,B17,B25,B26,B38,B41
GPS	BDS (1561.098MHz), Galileo/GPS (1575.42MHz), GLONASS (1602.000MHz)

### Data & Image Capture

Digital Camera	Autofocus 13 megapixels with user-controllable LED flash
Barcode Reader	2D Imager
HF RFID Reader	HF RFID 13.56 MHz (-18.18 dBuA/m at 10m) frequency which supports ISO14443A, ISO14443B, ISO15693, Felica Supports NFC (Peer-to-Peer, Card Reader, Card Emulation)

## ELECTRICAL CHARACTERISTICS

### Batteries

Main Battery Pack	<p>Replaceable and rechargeable 3.8V 4000mAh/3.75V 5300mAh Li-ion battery, full charging 4.35V Minimum charging time: 4 hours @25°C</p> <p>For the first time charging the main battery, please charge it for at least 8 to 12 hours. The allowed battery charging ambient temperature is between 0°C to 40°C. It is recommended to charge the battery at room temperature (18°C to 25°C) for optimal performance.</p> <p>Please note that battery charging stops when ambient temperature drops below 0°C or exceeds 40°C.</p>
Backup Battery	<p>Rechargeable Li-ion battery: 3.7V, 60 mAh, full charging 4.2V. Capable of Data retention for 30 minutes Charging time: 4 hours</p>

### Power Adaptor

Power Supply Cord with Universal Power Adaptor	Input	AC 100~240 V, 50/60 Hz
	Output	DC 5V, 2A CE, CB, BSMI, FCC, CCC, PSE, KC, CU, INMETRO (AC plug only), BIS

### Working Time

Supports working time for up to 12/16 (4000/5300 mAh main battery) hours at 25 degrees

## PHYSICAL CHARACTERISTICS

### Color Touch Screen Display

Display	4.7" LCD, Corning Gorilla Glass 3, touch supports bare/wet/gloved finger and stylus inputs
Resolution	HD (720x 1280 pixels)

### Notifications

Status LED	A Ttri-color (white, green, & red) LED indicators signaling charging and data capturing status
Audio	Integrated with one speaker playing sounds for events
Vibrator	Integrated with one vibrator for tactile feedback

### Dimensions & Weight

Dimensions	162 mm (L) x 80mm (W) x 26mm (H)
Weight	330g (equipped with 4000mAh battery) 365g (equipped with 5300mAh battery)

**ENVIRONMENTAL CHARACTERISTICS**

**Temperature**

---

Operating	-20°C to 50°C (-4°F to 122°F)
Storage	-30°C to 70°C (-22°F to 158°F)
Charging	0°C to 40°C

**Humidity**

---

Relative humidity	5% to 85% (Sharp temperature change, dewing, or freezing not allowed)
-------------------	--------------------------------------------------------------------------

**Resistance**

---

Impact Resistance	Multiple drops onto concrete at 1.8 m (6 ft.) on all six sides
Tumble Test	500 tumbles (1000 drops/hits) at 1 meter
Splash/Dust Resistance	IP65/67
Electrostatic Discharge	±15 kV air discharge, ±8 kV contact discharge



---

**PROGRAMMING SUPPORT**

---

**Development Environment & Tools**

JAVA	Environment Android studio Software Development Kit: JAR
C#	Environment: Visual Studio Software Development Kit: DLL (Xamarin Library)

---

**Software & Utilities**

Software Package	Reader Config Software Trigger Mobile Deployment Suite for Android App Lock Xamarin Binding HF RFID Configuration Signature Capture Terminal Emulation
------------------	-----------------------------------------------------------------------------------------------------------------------------------------------------------------------------

## APPENDIX I

### SCAN ENGINE SETTINGS

**Reader Configuration** sets the following reader types:

- ▶ 2D Imager

### SYMBOLOGIES SUPPORTED

Depending on the scan engine integrated on the mobile computer, supported symbologies will differ as listed below. For details on configuring associated settings, refer to [Appendix II](#).

		2D
<b>Codabar</b>		✓
<b>Code 11</b>		✓
<b>Code 39</b>	Code 39	✓
	Trioptic Code 39	✓
	Italian Pharmacode (Code 32)	✓
<b>Code 93</b>		✓
<b>Code 128</b>	Code 128	✓
	GS1-128 (EAN-128)	✓
	ISBT 128	✓
<b>Code 2 of 5</b>	Chinese 25	✓
	Industrial 25 (Discrete 25)	✓
	Interleaved 25	✓
	Convert Interleaved 25 to EAN-13	✓
	Matrix 25	✓
<b>Composite Code</b>	Composite CC-A/B	✓
	Composite CC-C	✓
	Composite TLC 39	✓
<b>GS1 DataBar (RSS)</b>	GS1 DataBar-14 (RSS-14)	✓
	GS1 DataBar Limited (RSS Limited)	✓
	GS1 DataBar Expanded (RSS Expanded)	✓
	Convert to UPC/EAN	✓
<b>Korean 3 of 5</b>		✓
<b>MSI</b>		✓
<b>Postal Codes</b>	Australian Postal	✓
	Japan Postal	✓

	Netherlands KIX Code	✓
	US Postnet	✓
	US Planet	✓
	USPS Postal	✓
	UPU FICS Postal	✓
	UK Postal	✓
<b>EAN/UPC</b>	EAN-8	✓
	EAN-8 Extend	✓
	EAN-13	✓
	Bookland EAN (ISBN)	✓
	ISSN EAN	✓
	UPC-A	✓
	UPC-E	✓
	Convert to UPC-A	✓
	UPC-E1	✓
	Convert to UPC-A	✓
<b>Coupon Code</b>		✓
<b>2D Symbologies</b>	Aztec	✓
	Data Matrix	✓
	Maxicode	✓
	MacroPDF	✓
	MicroPDF417	✓
	MicroQR	✓
	PDF417	✓
	QR Code	✓

## APPENDIX II

### 2D IMAGER



The tables below list the symbology settings for 2D imager.

#### SYMBOLGY SETTINGS

##### 1D SYMBOLOGIES

Symbology	Description	Default
<b>CODABAR</b>		
<b>Codabar</b>		Enable
Codabar	Switch to enable Codabar decoding.	Enable
Length Option	Set the length of the Codabar symbols to decode. <ul style="list-style-type: none"> <li>▶ One Fixed length (Length 1)</li> <li>▶ Two Fixed lengths (Length 1&gt;Length 2)</li> <li>▶ Max / Min Length (range: 0-55; Length 1&lt;Length 2)</li> <li>▶ Any Length</li> </ul>	Max / Min Length (4-55)
CLSI Editing	When applied, the CLSI editing strips the start/stop characters and inserts a space after the first, fifth, and tenth characters of a 14-character Codabar barcode. <ul style="list-style-type: none"> <li>▶ The 14-character barcode length does not include start/stop characters.</li> </ul>	Disable
NOTIS Editing	Set whether to include start/stop characters in the transmitted data. <ul style="list-style-type: none"> <li>▶ NOTIS Editing is to strip the start/stop characters, i.e. to disable "Transmit Start/Stop Characters".</li> </ul>	Disable
NOTIS Editing Type	Options are <b>None, ABCD/ABCD, abcd/abcd</b> . "NOTIS Editing" must be enabled.	None
Verify Check Digit	Select whether to verify the Modulo 43 check digit. If the check digit is incorrect, the barcode will not be accepted.	None
Transmit Check Digit	Decide whether to include the check digit in the data to transmit. "Verify Check Digit" must be enabled.	Enable

Symbology	Description	Default
<b>CODE 11</b>		
<b>Code 11</b>		Enable
Code 11	Switch to enable Code 11 decoding.	Enable
Check Digit Option	Set whether to verify check digits according to the selected option. If the check digits are incorrect, the barcode will not be accepted. <ul style="list-style-type: none"> <li>▶ Disable</li> <li>▶ One Check Digit</li> <li>▶ Two Check Digit</li> </ul>	Disable
Transmit Check Digit	Selects whether to include check digits in the transmitted data. <ul style="list-style-type: none"> <li>▶ "Check Digit Option" must be enabled.</li> </ul>	Disable
Length option	Sets the length of the Code 11 symbols to decode. <ul style="list-style-type: none"> <li>▶ One Fixed length (Length 1)</li> <li>▶ Two Fixed lengths (Length 1&gt;Length 2)</li> <li>▶ Max / Min Length (range: 0-55; Length 1&lt;Length 2)</li> <li>▶ Any Length</li> </ul>	Max / Min Length (4-55)
<b>CODE 39</b>		
<b>Code 39</b>		Enable
Code 39	Switch to enable Code 39 decoding.	Enable
Convert to Code 32	Selects whether to convert decoded data to Italian Pharmacode.	Disable
Code 32 Prefix	Prefix character "A" to Code 32 barcodes. <ul style="list-style-type: none"> <li>▶ "Convert to Code 32" must be enabled for this to function properly.</li> </ul>	Disable
Verify Check Digit	Selects whether to verify the Modulo 43 check digit. If the check digit is incorrect, the barcode will not be accepted.	Disable
Transmit Check Digit	Decide whether to include the check digit in the data to transmit. <ul style="list-style-type: none"> <li>▶ "Verify Check Digit" must be enabled.</li> </ul>	Disable
Support Full ASCII	Selects whether to enable Code 39 Full ASCII decoding. Characters are paired to encode the full ASCII character set.	Disable
Length option	Sets the length of the Code 39 symbols to decode. <ul style="list-style-type: none"> <li>▶ One Fixed length (Length 1)</li> <li>▶ Two Fixed lengths (Length 1&gt;Length 2)</li> <li>▶ Max / Min Length (range: 0-55; Length 1&lt;Length 2)</li> <li>▶ Any Length</li> </ul>	Max / Min Length (4-55)
Security Level	Select the security level from <b>Level 0</b> to <b>Level 3</b>	Level 1

Symbology	Description	Default
<b>Trioptic Code 39</b>		
<b>Trioptic Code 39</b>		Disable
Trioptic Code 39	Switch to enable Trioptic Code 39 decoding.	Disable
<b>Code 93</b>		
<b>Code 93</b>		Enable
Code 93	Switch to enable Code 93 decoding.	Enable
Length option	<p>Sets the length of the Code 39 symbols to decode.</p> <ul style="list-style-type: none"> <li>▶ One Fixed length (Length 1)</li> <li>▶ Two Fixed lengths (Length 1&gt;Length 2)</li> <li>▶ Max / Min Length (range: 0-55; Length 1&lt;Length 2)</li> <li>▶ Any Length</li> </ul>	Max / Min Length (4-55)
<b>CODE 128</b>		
<b>Code 128</b>		Enable
Code 128	Switch to enable Code 128 decoding.	Enable
Length option	<p>Sets the length of the Code 128 symbols to decode.</p> <ul style="list-style-type: none"> <li>▶ One Fixed length (Length 1)</li> <li>▶ Two Fixed lengths (Length 1&gt;Length 2)</li> <li>▶ Max / Min Length (range: 0-55; Length 1&lt;Length 2)</li> <li>▶ Any Length</li> </ul>	Max / Min Length (4-55)
<b>GS1-128</b>		Enable
GS1-128	Switch to enable GS1-128 decoding.	Enable
Separator Character	<p>Enable the function code character separator, which is used to separate data fields of variable length and application identifiers of subsequent data fields in concatenated data strings.</p> <p>Tap on  to choose your input method between <b>Keyboard input</b> and <b>Symbol table input</b> to set a separator character to replace with.</p>	None
Enable App ID Separator	<p>Check to enable the separator configuration for Application Identifier.</p>  <p>(00)123456789012345675  <small>Left Separator      Right Separator</small></p> <p>You can respectively set the Left Separator and Right Separator. Tap on  to choose your input method between Keyboard input and Symbol table input to set a separator character to replace with.</p>	Disable

Symbology	Description	Default
<b>ISBT 128</b>		Enable
ISBT 128	Switch to enable ISBT 128 decoding.	Enable
Concatenation	Sets whether to enable decoding ISBT 128 by performing concatenation of ISBT data. <ul style="list-style-type: none"> <li>▶ <b>Disable:</b> Does not perform concatenation</li> <li>▶ <b>Enable:</b> Performs concatenation on all ISBT-128 barcodes.</li> <li>▶ <b>Auto-discriminate:</b> Auto-discriminates between the ISBT 128 barcodes which require concatenation and those which do not need concatenation.</li> </ul>	Auto-discriminate
Redundancy	When “Auto-discriminate” is applied, decide the number of times of supplementary decoding the same barcode to count as a valid read. Configurable between 2 and 20.	10
<b>CODE 2 OF 5</b>		
<b>Chinese 25</b>		Enable
Chinese 25	Switch to enable Chinese 2 of 5 decoding.	Enable
<b>Discrete 25</b>		Enable
Discrete 25	Switch to enable Discrete 2 of 5 decoding.	Enable
Length option	Sets the length of the Discrete 2 of 5 symbols to decode. <ul style="list-style-type: none"> <li>▶ One Fixed length (Length 1)</li> <li>▶ Two Fixed lengths (Length 1&gt;Length 2)</li> <li>▶ Max / Min Length (range: 0-55; Length 1&lt;Length 2)</li> <li>▶ Any Length</li> </ul>	Max / Min Length (4-55)
<b>Interleaved 25</b>		
<b>Interleaved 25</b>		Enable
Interleaved 25	Switch to enable Interleaved 2 of 5 decoding.	Enable
Length option	Sets the length of Interleaved 2 of 5 symbols to decode. <ul style="list-style-type: none"> <li>▶ One Fixed length (Length 1)</li> <li>▶ Two Fixed lengths (Length 1&gt;Length 2)</li> <li>▶ Max / Min Length (range: 0-55; Length 1&lt;Length 2)</li> <li>▶ Any Length</li> </ul>	Max / Min Length (4-55)
Verify Check Digit	Decide whether to verify the check digit. If the check digit is incorrect, the barcode will not be accepted.	Disable
Transmit Check Digit	Decide whether to include the check digit in the data to transmit.	Disable
Convert to EAN-13	Convert a 14-character Interleaved 25 barcode into EAN-13 if the following requirements are met: <ul style="list-style-type: none"> <li>▶ The barcode must have a leading 0 and a valid EAN-13 check digit.</li> </ul>	Disable
Security Level	Select the security level from <b>Level 0</b> to <b>Level 3</b>	Level 1

Symbology	Description	Default
<b>Matrix 25</b>		Enable
Matrix 25	Switch to enable Matrix 2 of 5 decoding.	Enable
Length option	Sets the length of the Matrix 2 of 5 symbols to decode. <ul style="list-style-type: none"> <li>▶ One Fixed length (Length 1)</li> <li>▶ Two Fixed lengths (Length 1&gt;Length 2)</li> <li>▶ Max / Min Length (range: 0-55; Length 1&lt;Length 2)</li> <li>▶ Any Length</li> </ul>	Max / Min Length (4-55)
Redundancy	Enables or disable read redundancy for Matrix 2 of 5.	Disable
Verify Check Digit	Decide whether to verify the check digit. If the check digit is incorrect, the barcode will not be accepted.	Disable
Transmit Check Digit	Decide whether to include the check digit in the data to transmit.	Disable
<b>Composite</b>		
<b>Composite CC-A/B</b>		Disable
Composite CC-A/B	Switch to enable Composite CC-A/B decoding.	Disable
<b>Composite CC-C</b>		Enable
Composite CC-C	Switch to enable Composite CC-C decoding.	Enable
<b>Composite TLC-39</b>		Disable
Composite TLC-39	Switch to enable Composite TLC-39 decoding.	Disable
<b>Composite General Preference</b>		
UPC Composite Mode	UPC barcodes can be “linked” with a 2D barcode during transmission as if they were one barcode. <ul style="list-style-type: none"> <li>▶ <b>UPC Never Linked:</b> Transmit UPC barcodes regardless of whether a 2D barcode is detected.</li> <li>▶ <b>UPC Always Linked:</b> Transmit UPC barcodes and the 2D portion. If the 2D portion is not detected, the UPC barcode will not be transmitted.</li> </ul> <p style="color: red; margin: 0;"><b>Note: CC-A/B or CC-C must be enabled.</b></p> <ul style="list-style-type: none"> <li>▶ <b>Auto-discriminate:</b> Transmit UPC barcodes as well as the 2D portion if present.</li> </ul>	UPC always Linked
GS1-128 Emulation Mode	Sets GS1-128 emulation mode for UCC/EAN Composite Codes.	Disable



Symbology	Description	Default
<b>GS1 DataBar</b>		
<b>GS1 DataBar-14</b>		Enable
GS1 DataBar-14	Switch to enable GS1 DataBar-14 decoding.	Enable
Convert to UPC/EAN	Strips the leading '010' of GS1 DataBar and converts the barcode to EAN-13.	Disable
Security Level	Select the security level from <b>Level 0</b> to <b>Level 3</b>	Level 1
<b>GS1 DataBar Limited</b>		Enable
GS1 DataBar Limited	Switch to enable GS1 DataBar Limited decoding.	Enable
Convert to UPC/EAN	Strips the leading '010' of GS1 DataBar Limited and converts the barcode to EAN-13.	Disable
Security Level	Select the security level from <b>Level 0</b> to <b>Level 3</b>	Level 3
Transmit Check Digit	Decide whether to include the check digit in the data to transmit.	Enable
Transmit Application ID	Decide whether to transmit the Application ID ("01").	Enable
<b>GS1 DataBar Expanded</b>		Enable
GS1 DataBar Expanded	Switch to enable GS1 DataBar Expanded decoding.	Enable
Separator Character	Separator Character Enable the function code character separator, which is used to separate data fields of variable length and application identifiers of subsequent data fields in concatenated data strings.	None
Security Level	Select the security level from <b>Level 0</b> to <b>Level 3</b>	Level 1
<b>Korean 3 OF 5</b>		
<b>Korean 3 of 5</b>		Disable
Korean 3 of 5	Switch to enable Korean 3 of 5 decoding.	Disable
<b>MSI</b>		
<b>MSI</b>		Enable
MSI	Switch to enable MSI decoding.	Enable
Length option	Sets the length of the MSI symbols to decode. <ul style="list-style-type: none"> <li>▶ One Fixed length (Length 1)</li> <li>▶ Two Fixed lengths (Length 1&gt;Length 2)</li> <li>▶ Max / Min Length (range: 0-55; Length 1&lt;Length 2)</li> <li>▶ Any Length</li> </ul>	Max / Min Length (4-55)



<b>Symbology</b>	<b>Description</b>	<b>Default</b>
Verify Check Digit	One check digit is mandatory for decoding MSI barcodes. Select whether a second check digit should be verified. If the check digits are incorrect, the barcode will not be accepted. <ul style="list-style-type: none"> <li>▶ One Check Digit</li> <li>▶ Two Check Digits</li> </ul>	One Check Digit
Transmit Check Digit	Decide whether to include the check digit in the data to transmit.	Disable
Algorithm	When two check digits are set for verification, two choices are available for the pair of check digits. <ul style="list-style-type: none"> <li>▶ Modulo10 / Modulo11</li> <li>▶ Double Modulo 10</li> </ul>	Double Modulo 10
<b>Postal</b>		
<b>Australian Postal</b>		Enable
<b>Japan Postal</b>		Enable
<b>Netherlands KIX Code</b>		Enable
<b>US Postnet</b>		Enable
<b>US Planet</b>		Enable
<b>USPS Postal</b>		Enable
<b>UPU FICS Postal</b>		Enable
<b>UK Postal</b>		Enable
<b>Postal General Preference</b>		
US Postal Check Digit	Decide whether to transmit check digit for US Postnet or US Planet.	Enable
UK Postal Check Digit	Decide whether to transmit check digit for UK Postal.	Enable
<b>EAN</b>		
<b>EAN-8</b>		Enable
EAN-8	Switch to enable EAN-8 decoding.	Enable
Addon 2	Decide whether to decode EAN-8 with addon 2. <ul style="list-style-type: none"> <li>▶ Ignore Addon</li> <li>▶ Auto-discriminate</li> </ul>	Ignore addon
Addon 5	Decide whether to decode EAN-8 with addon 5. <ul style="list-style-type: none"> <li>▶ Ignore Addon</li> <li>▶ Auto-discriminate</li> </ul>	Ignore addon
Transmit Check Digit	Decide whether to include the check digit in the data being transmitted.	Enable
Convert to EAN-13	Checkbox to enable converting EAN-8 to EAN-13 format.	Disable

Symbology	Description	Default
<b>EAN-13</b>		Enable
EAN-13	Switch to enable EAN-13 decoding.	Enable
Bookland EAN	Checkbox to enable ISBN decoding. If enabled, select Bookland ISBN Format below.	Disable
Bookland ISBN Format	Decodes Bookland data starting with 978 in 10-digit format along with the Bookland check digit, or Bookland data starting with 978/979 in 13-digit format.	Bookland ISBN-10
Addon 2	Decide whether to decode EAN-13 with addon 2. <ul style="list-style-type: none"> <li>▶ Ignore Addon</li> <li>▶ Auto-discriminate</li> </ul>	Ignore addon
Addon 5	Decide whether to decode EAN-13 with addon 5. <ul style="list-style-type: none"> <li>▶ Ignore Addon</li> <li>▶ Auto-discriminate</li> </ul>	Ignore addon
Transmit Check Digit	Decide whether to include the EAN-13 check digit (the last character in the barcode) in the data being transmitted.	Enable
ISSN EAN	Checkbox to enable ISSN EAN decoding.	Disable
<b>UPC</b>		
<b>UPC-A</b>		Enable
UPC-A	Switch to enable UPC-A decoding.	Enable
Addon 2	Decide whether to decode UPC-A with addon 2. <ul style="list-style-type: none"> <li>▶ Ignore Addon</li> <li>▶ Auto-discriminate</li> </ul>	Ignore addon
Addon 5	Decide whether to decode UPC-A with addon 5. <ul style="list-style-type: none"> <li>▶ Ignore Addon</li> <li>▶ Auto-discriminate</li> </ul>	Ignore addon
Preamble	Decide whether to include the UPC-A preamble System Character (and Country Code) in the data being transmitted. <ul style="list-style-type: none"> <li>▶ <b>No transmit:</b> transmits none of the above</li> <li>▶ <b>Transmit System Character:</b> transmits system number only</li> <li>▶ <b>Transmit Sys. Character and Country Code:</b> transmits system number and country code</li> </ul>	Transmit System Character
Transmit Check Digit	Decide whether to include the UPC-A check digit (the last character in the barcode) in the data being transmitted.	Enable
Convert to EAN-13	Checkbox to enable converting EAN-8 to EAN-13 format.	Disable

Symbology	Description	Default
<b>UPC-E</b>		Enable
UPC-E	Switch to enable UPC-E decoding.	Enable
Addon 2	Decide whether to decode UPC-E with addon 2. <ul style="list-style-type: none"> <li>▶ Ignore Addon</li> <li>▶ Auto-discriminate</li> </ul>	Ignore addon
Addon 5	Decide whether to decode UPC-E with addon 5. <ul style="list-style-type: none"> <li>▶ Ignore Addon</li> <li>▶ Auto-discriminate</li> </ul>	Ignore addon
Preamble	Decide whether to include the UPC-E preamble System Character (and Country Code) in the data being transmitted. <ul style="list-style-type: none"> <li>▶ <b>No transmit:</b> transmits none of the above</li> <li>▶ <b>Transmit System Character:</b> transmits system number only</li> <li>▶ <b>Transmit Sys. Character and Country Code:</b> transmits system number and country code</li> </ul>	Transmit System Character
Convert to UPC-A	The UPC-E barcode will be expanded into UPC-A format, and the next process will follow the settings configured for UPC-A.	Disable
Transmit Check Digit	Decide whether to include the UPC-E1 check digit (the last character in the barcode) in the data being transmitted.	Enable
<b>UPC-E1</b>		Disable
UPC-E1	Switch to enable UPC-E1 decoding.	Disable
Addon 2	Decide whether to decode UPC-E1 with addon 2. <ul style="list-style-type: none"> <li>▶ Ignore Addon</li> <li>▶ Auto-discriminate</li> </ul>	Ignore addon
Addon 5	Decide whether to decode UPC-E1 with addon 5. <ul style="list-style-type: none"> <li>▶ Ignore Addon</li> <li>▶ Auto-discriminate</li> </ul>	Ignore addon
Preamble	Decide whether to include the UPC-E1 preamble System Character (and Country Code) in the data being transmitted. <ul style="list-style-type: none"> <li>▶ <b>No transmit:</b> transmits none of the above</li> <li>▶ <b>Transmit System Character:</b> transmits system number only</li> <li>▶ <b>Transmit Sys. Character and Country Code:</b> transmits system number and country code</li> </ul>	Transmit System Character
Convert to UPC-A	The UPC-E1 barcode will be expanded into UPC-A format, and the next process will follow the settings configured for UPC-A.	Disable
Transmit Check Digit	Decide whether to include the UPC-E1 check digit (the last character in the barcode) in the data being transmitted.	Enable

Symbology	Description	Default
<b>Coupon Code</b>		
<b>Goupon Code</b>		Disable
Coupon Code	Switch to enable Coupon Code decoding.	Disable

## 2D SYMBOLOGIES

Symbology	Description	Default
<b>Aztec</b>		
<b>Aztec</b>		Enable
Aztec	Switch to enable Aztec decoding.	Enable
<b>Data Matrix</b>		
<b>Data Matrix</b>		Enable
Data Matrix	Switch to enable Data Matrix decoding.	Enable
Decode Mirror Image	<p>Switch to enable decode mirror images.</p> <ul style="list-style-type: none"> <li>▶ <b>Never:</b> Does not decode Data Matrix barcodes that are mirror images.</li> <li>▶ <b>Always:</b> Decodes Data Matrix barcodes that are mirror images.</li> <li>▶ <b>Auto-discriminate:</b> Decodes both mirrored and unmirrored Data Matrix barcodes.</li> </ul>	Never
Separator Character	<p>Enable the function code character separator, which is used to separate data fields of variable length and application identifiers of subsequent data fields in concatenated data strings.</p> <p>Tap on  to choose your input method between Keyboard input and Symbol table input to set a separator character to replace with.</p>	None
Enable App ID Separator	<p>Check to enable the separator configuration for Application Identifier. You can respectively set the <b>Left Separator</b> and <b>Right Separator</b>. Tap on  to choose your input method between <b>Keyboard input</b> and <b>Symbol table input</b> to set a separator character to replace with.</p>	Disable

Symbology	Description	Default
<b>MaxiCode</b>		
<b>MaxiCode</b>		Enable
MaxiCode	Switch to enable MaxiCode decoding.	Enable
<b>MicroPDF417</b>		
<b>MicroPDF417</b>		Disable
MicroPDF417	Switch to enable MicroPDF417 decoding.	Disable
Code 128 Emulation	<p>Transmit data from certain Micro PDF 417 barcodes as if it was encoded in Code 128 barcodes.</p> <p><b>Note: <a href="#">Transmit AIM code ID</a> character in "Scanner Preferences" must be enabled first. When applied, the MicroPDF417 barcodes are transmitted with one of these prefixes:</b></p> <ul style="list-style-type: none"> <li>▶ <b>The first codeword of MicroPDF417 is 903-905:</b> The original Code ID "]L3" will be changed to "]C1".</li> <li>▶ <b>The first codeword of MicroPDF417 is 908 or 909:</b> The original Code ID "]L4" will be changed to "]C2".</li> <li>▶ <b>The first codeword of MicroPDF417 is 910 or 911:</b> The original Code ID "]L5" will be changed to "]C0".</li> </ul>	Disable
<b>MicroQR</b>		
<b>MicroQR</b>		Enable
MicroQR	Switch to enable MicroQR decoding.	Enable
<b>PDF417</b>		
<b>PDF417</b>		Enable
PDF417	Switch to enable PDF417 decoding.	Enable
<b>QR Code</b>		
<b>QR Code</b>		Enable
QR Code	Switch to enable QR Code decoding.	Enable
<b>MRZ</b>		
<b>MRZ</b>		Disable
MRZ	Switch to enable MRZ decoding.	Disable
MRZ Mode	<p>Tap to select:</p> <ul style="list-style-type: none"> <li>▶ OCR-B Travel Documents Version 1 (3-Line ID Cards)</li> <li>▶ OCR-B Travel Documents Version 2 (2-Line ID Cards)</li> <li>▶ OCR-B Travel Documents 2 or 3-Line ID Cards Auto-Detect</li> <li>▶ OCR-B Passport</li> <li>▶ OCR-B Visa Type A</li> <li>▶ OCR-B Visa Type B</li> <li>▶ OCR-B ICAO Travel Documents</li> </ul>	OCR-B ICAO Travel Documents

## SYMBOLGY SETTINGS (FOR SM2)



## 1D SYMBOLOGIES

Symbology	Description	Default
<b>CODABAR</b>		
<b>Codabar</b>		Enable
Codabar	Switch to enable Codabar decoding.	Enable
Length Option	Set the length of the Codabar symbols to decode. <ul style="list-style-type: none"> <li>▶ One Fixed length (Length 1)</li> <li>▶ Two Fixed lengths (Length 1&gt;Length 2)</li> <li>▶ Max / Min Length (range: 0-55; Length 1&lt;Length 2)</li> <li>▶ Any Length</li> </ul>	Max / Min Length (4-55)
CLSI Editing	When applied, the CLSI editing strips the start/stop characters and inserts a space after the first, fifth, and tenth characters of a 14-character Codabar barcode. <ul style="list-style-type: none"> <li>▶ The 14-character barcode length does not include start/stop characters.</li> </ul>	Disable
NOTIS Editing	Set whether to include start/stop characters in the transmitted data. <ul style="list-style-type: none"> <li>▶ NOTIS Editing is to strip the start/stop characters, i.e. to disable "Transmit Start/Stop Characters".</li> </ul>	Disable
NOTIS Editing Type	Options are <b>None, ABCD/ABCD, abcd/abcd</b> . "NOTIS Editing" must be enabled.	None
Verify Check Digit	Select whether to verify the Modulo 43 check digit. If the check digit is incorrect, the barcode will not be accepted.	None
Transmit Check Digit	Decide whether to include the check digit in the data to transmit. "Verify Check Digit" must be enabled.	Enable
Security Level	Setting options are <b>Normal</b> and <b>High</b> .	High

Symbology	Description	Default
<b>CODE 11</b>		
<b>Code 11</b>		Disable
Code 11	Switch to enable Code 11 decoding.	Disable
Check Digit Option	Set whether to verify check digits according to the selected option. If the check digits are incorrect, the barcode will not be accepted. <ul style="list-style-type: none"> <li>▶ Disable</li> <li>▶ One Check Digit</li> <li>▶ Two Check Digit</li> </ul>	Disable
Transmit Check Digit	Selects whether to include check digits in the transmitted data. <ul style="list-style-type: none"> <li>▶ Check Digit Option" must be enabled.</li> </ul>	Disable
Length option	Sets the length of the Code 11 symbols to decode. <ul style="list-style-type: none"> <li>▶ One Fixed length (Length 1)</li> <li>▶ Two Fixed lengths (Length 1&gt;Length 2)</li> <li>▶ Max / Min Length (range: 0-55; Length 1&lt;Length 2)</li> <li>▶ Any Length</li> </ul>	Max / Min Length (4-55)
Security Level	Setting options are <b>Normal</b> and <b>High</b> .	High
<b>CODE 39</b>		
<b>Code 39</b>		Enable
Code 39	Switch to enable Code 39 decoding.	Enable
Convert to Code 32	Selects whether to convert decoded data to Italian Pharmacode.	Disable
Transmit Check Digit (Code 32)	Decide whether to include the check digit in the data to transmit. <ul style="list-style-type: none"> <li>▶ "Convert to Code 32" must be enabled.</li> </ul>	Disable
Verify Check Digit	Selects whether to verify the Modulo 43 check digit. If the check digit is incorrect, the barcode will not be accepted.	Disable
Transmit Check Digit	Decide whether to include the check digit in the data to transmit. <ul style="list-style-type: none"> <li>▶ "Verify Check Digit" must be enabled.</li> </ul>	Disable
Support Full ASCII	Selects whether to enable Code 39 Full ASCII decoding. Characters are paired to encode the full ASCII character set.	Disable
Length option	Sets the length of the Code 39 symbols to decode. <ul style="list-style-type: none"> <li>▶ One Fixed length (Length 1)</li> <li>▶ Two Fixed lengths (Length 1&gt;Length 2)</li> <li>▶ Max / Min Length (range: 0-55; Length 1&lt;Length 2)</li> <li>▶ Any Length</li> </ul>	Max / Min Length (4-55)



Symbology	Description	Default
Security Level	Setting options are <b>Normal</b> and <b>High</b> .	Normal
Transmit Start/Stop Character	Select whether to include start/stop characters in the transmitted data.	Disable
Asterisk As Data Characters	Select whether to use asterisk as the data characters.	Disable
<b>CODE 93</b>		
<b>Code 93</b>		Enable
Code 93	Switch to enable Code 93 decoding.	Enable
Length option	<p>Sets the length of the Code 93 symbols to decode.</p> <ul style="list-style-type: none"> <li>▶ One Fixed length (Length 1)</li> <li>▶ Two Fixed lengths (Length 1&gt;Length 2)</li> <li>▶ Max / Min Length (range: 0-55; Length 1&lt;Length 2)</li> <li>▶ Any Length</li> </ul>	Max / Min Length (4-55)
<b>CODE 128</b>		
<b>Code 128</b>		Enable
Code 128	Switch to enable Code 128 decoding.	Enable
Security Level	Setting options are <b>Normal</b> and <b>High</b> .	Normal
Length option	<p>Sets the length of the Code 128 symbols to decode.</p> <ul style="list-style-type: none"> <li>▶ One Fixed length (Length 1)</li> <li>▶ Two Fixed lengths (Length 1&gt;Length 2)</li> <li>▶ Max / Min Length (range: 0-55; Length 1&lt;Length 2)</li> <li>▶ Any Length</li> </ul>	Max / Min Length (4-55)
<b>GS1-128</b>		Enable
GS1-128	Switch to enable GS1-128 decoding.	Enable
Separator Character	<p>Enable the function code character separator, which is used to separate data fields of variable length and application identifiers of subsequent data fields in concatenated data strings.</p> <p>Tap on  to choose your input method between <b>Keyboard input</b> and <b>Symbol table input</b> to set a separator character to replace with.</p>	None

Symbology	Description	Default
Enable App ID Separator	<p>Check to enable the separator configuration for Application Identifier.</p>  <p>You can respectively set the Left Separator and Right Separator. Tap on  to choose your input method between Keyboard input and Symbol table input to set a separator character to replace with.</p>	Disable
<b>ISBT 128</b>		Enable
ISBT 128	Switch to enable ISBT 128 decoding.	Enable
Concatenation	<p>Sets whether to enable decoding ISBT 128 by performing concatenation of ISBT data.</p> <ul style="list-style-type: none"> <li>▶ <b>Disable:</b> Does not perform concatenation</li> <li>▶ <b>Enable:</b> Performs concatenation on all ISBT-128 barcodes.</li> <li>▶ <b>Auto-discriminate:</b> Auto-discriminates between the ISBT 128 barcodes which require concatenation and those which do not need concatenation.</li> </ul>	Disable
<b>Discrete 25</b>		
<b>Discrete 25</b>		Enable
Discrete 25	Switch to enable Discrete 2 of 5 decoding.	Enable
Length option	<p>Sets the length of the Discrete 2 of 5 symbols to decode.</p> <ul style="list-style-type: none"> <li>▶ One Fixed length (Length 1)</li> <li>▶ Two Fixed lengths (Length 1&gt;Length 2)</li> <li>▶ Max / Min Length (range: 0-55; Length 1&lt;Length 2)</li> <li>▶ Any Length</li> </ul>	Max / Min Length (4-55)
Start Stop Selection	<p>This decides the readability of all 2 of 5 symbology Variants. For example, flight tickets actually use an Industrial 2 of 5 barcode but with Interleaved 2 of 5 start/stop pattern. In order to read this barcode, the start/stop pattern selection parameter of Industrial 2 of 5 should set to "Interleaved 25"</p> <ul style="list-style-type: none"> <li>▶ Discrete 25</li> <li>▶ Interleaved 25</li> <li>▶ Matrix 25</li> </ul>	Discrete 25
Verify Check Digit	Decide whether to verify the check digit. If the check digit is incorrect, the barcode will not be accepted.	Disable
Transmit Check Digit	Decide whether to include the check digit in the data to transmit.	Enable

Symbology	Description	Default
<b>Interleaved 25</b>		
<b>Interleaved 25</b>		Enable
Interleaved 25	Switch to enable Interleaved 2 of 5 decoding.	Enable
Length option	<p>Sets the length of Interleaved 2 of 5 symbols to decode.</p> <ul style="list-style-type: none"> <li>▶ One Fixed length (Length 1)</li> <li>▶ Two Fixed lengths (Length 1&gt;Length 2)</li> <li>▶ Max / Min Length (range: 0-55; Length 1&lt;Length 2)</li> <li>▶ Any Length</li> </ul>	Max / Min Length (4-55)
Verify Check Digit	Decide whether to verify the check digit. If the check digit is incorrect, the barcode will not be accepted.	Disable
Transmit Check Digit	Decide whether to include the check digit in the data to transmit.	Disable
Start Stop Selection	<p>This decides the readability of all 2 of 5 symbology Variants. For example, flight tickets actually use an Industrial 2 of 5 barcode but with Interleaved 2 of 5 start/stop pattern. In order to read this barcode, the start/stop pattern selection parameter of Industrial 2 of 5 should set to "Interleaved 25"</p> <ul style="list-style-type: none"> <li>▶ Discrete 25</li> <li>▶ Interleaved 25</li> <li>▶ Matrix 25</li> </ul>	Interleaved 25
<b>Matrix 25</b>		
<b>Matrix 25</b>		Enable
Matrix 25	Switch to enable Matrix 2 of 5 decoding.	Enable
Length option	<p>Sets the length of the Matrix 2 of 5 symbols to decode.</p> <ul style="list-style-type: none"> <li>▶ One Fixed length (Length 1)</li> <li>▶ Two Fixed lengths (Length 1&gt;Length 2)</li> <li>▶ Max / Min Length (range: 0-55; Length 1&lt;Length 2)</li> <li>▶ Any Length</li> </ul>	Max / Min Length (4-55)
Verify Check Digit	Decide whether to verify the check digit. If the check digit is incorrect, the barcode will not be accepted.	Disable
Transmit Check Digit	Decide whether to include the check digit in the data to transmit.	Disable
Start Stop Selection	<p>This decides the readability of all 2 of 5 symbology Variants. For example, flight tickets actually use an Industrial 2 of 5 barcode but with Interleaved 2 of 5 start/stop pattern. In order to read this barcode, the start/stop pattern selection parameter of Industrial 2 of 5 should set to "Interleaved 25"</p> <ul style="list-style-type: none"> <li>▶ Discrete 25</li> <li>▶ Interleaved 25</li> <li>▶ Matrix 25</li> </ul>	Matrix 25

Symbology	Description	Default
<b>Composite</b>		
<b>Composite CC-A/B</b>		Disable
Composite CC-A/B	Switch to enable Composite CC-A/B decoding.	Disable
<b>Composite CC-C</b>		Disable
Composite CC-C	Switch to enable Composite CC-C decoding.	Disable
<b>Composite General Preference</b>		
UPC Composite Mode	<p>UPC barcodes can be "linked" with a 2D barcode during transmission as if they were one barcode.</p> <ul style="list-style-type: none"> <li>▶ <b>UPC Never Linked:</b> Transmit UPC barcodes regardless of whether a 2D barcode is detected.</li> <li>▶ <b>UPC Always Linked:</b> Transmit UPC barcodes and the 2D portion. If the 2D portion is not detected, the UPC barcode will not be transmitted.</li> </ul> <p><b>Note: CC-A/B or CC-C must be enabled.</b></p> <ul style="list-style-type: none"> <li>▶ <b>Auto-discriminate:</b> Transmit UPC barcodes as well as the 2D portion if present.</li> </ul>	UPC always Linked
<b>GS1 DataBar</b>		
<b>GS1 DataBar-14</b>		Disable
GS1 DataBar-14	Switch to enable GS1 DataBar-14 decoding.	Disable
Security Level	Setting options are <b>Normal</b> and <b>High</b> .	Normal
Transmit Check Digit	Decide whether to include the check digit in the data to transmit.	Enable
Transmit Application ID	Decide whether to transmit the Application ID ("01").	Enable
<b>GS1 DataBar Limited</b>		Disable
GS1 DataBar Limited	Switch to enable GS1 DataBar Limited decoding.	Disable
Security Level	Setting options are <b>Normal</b> and <b>High</b> .	Normal
Transmit Check Digit	Decide whether to include the check digit in the data to transmit.	Enable
Transmit Application ID	Decide whether to transmit the Application ID ("01").	Enable
<b>GS1 DataBar Expanded</b>		Disable
GS1 DataBar Expanded	Switch to enable GS1 DataBar Expanded decoding.	Disable
Security Level	Setting options are <b>Normal</b> and <b>High</b> .	Normal

Symbology	Description	Default
<b>MSI</b>		
<b>MSI</b>		Disable
MSI	Switch to enable MSI decoding.	Disable
Length option	Sets the length of the MSI symbols to decode. <ul style="list-style-type: none"> <li>▶ One Fixed length (Length 1)</li> <li>▶ Two Fixed lengths (Length 1&gt;Length 2)</li> <li>▶ Max / Min Length (range: 0-55; Length 1&lt;Length 2)</li> <li>▶ Any Length</li> </ul>	Max / Min Length (4-55)
Verify Check Digit	One check digit is mandatory for decoding MSI barcodes. Select whether a second check digit should be verified. If the check digits are incorrect, the barcode will not be accepted. <ul style="list-style-type: none"> <li>▶ One Check Digit</li> <li>▶ Two Check Digits</li> </ul>	One Check Digit
Transmit Check Digit	Decide whether to include the check digit in the data to transmit.	Disable
Algorithm	When two check digits are set for verification, two choices are available for the pair of check digits. <ul style="list-style-type: none"> <li>▶ Modulo10 / Modulo11</li> <li>▶ Double Modulo 10</li> </ul>	Double Modulo 10
<b>EAN</b>		
<b>EAN-8</b>		Enable
EAN-8	Switch to enable EAN-8 decoding.	Enable
Addon 2	Decide whether to decode EAN-8 with addon 2. <ul style="list-style-type: none"> <li>▶ Ignore Addon</li> <li>▶ Auto-discriminate</li> </ul>	Ignore Addon
Addon 5	Decide whether to decode EAN-8 with addon 5. <ul style="list-style-type: none"> <li>▶ Ignore Addon</li> <li>▶ Auto-discriminate</li> </ul>	Ignore Addon
Transmit Check Digit	Decide whether to include the check digit in the data to transmit.	Enable
Convert to EAN-13	Decide whether to enable converting EAN-8 to EAN-13 format.	Disable

Symbology	Description	Default
<b>EAN-13</b>		Enable
EAN-13	Switch to enable EAN-13 decoding.	Enable
Bookland EAN	Switch to enable Bookland EAN decoding.	Disable
Addon 2	Decide whether to decode EAN-13 with addon 2. <ul style="list-style-type: none"> <li>▶ Ignore Addon</li> <li>▶ Auto-discriminate</li> </ul>	Ignore Addon
Addon 5	Decide whether to decode EAN-13 with addon 5. <ul style="list-style-type: none"> <li>▶ Ignore Addon</li> <li>▶ Auto-discriminate</li> </ul>	Ignore Addon
Transmit Check Digit	Decide whether to include the check digit in the data to transmit.	Enable
ISSN EAN	Switch to enable ISSN EAN decoding.	Disable
Security Level	Setting options are <b>Normal</b> and <b>High</b> .	Normal
<b>UPC</b>		
<b>UPC-A</b>		Enable
UPC-A	Switch to enable UPC-A decoding.	Enable
Addon 2	Decide whether to decode UPC-A with addon 2. <ul style="list-style-type: none"> <li>▶ Ignore Addon</li> <li>▶ Auto-discriminate</li> </ul>	Ignore Addon
Addon 5	Decide whether to decode UPC-A with addon 5. <ul style="list-style-type: none"> <li>▶ Ignore Addon</li> <li>▶ Auto-discriminate</li> </ul>	Ignore Addon
Preamble	Decide whether to include the UPC-A preamble System Character (and Country Code) in the data being transmitted. <ul style="list-style-type: none"> <li>▶ <b>No transmit:</b> transmits none of the above</li> <li>▶ <b>Transmit System Character:</b> transmits system number only</li> <li>▶ <b>Transmit Sys. Character and Country Code:</b> transmits system number and country code</li> </ul>	Transmit System Character
Transmit Check Digit	Decide whether to include the UPC-A check digit (the last character in the barcode) in the data being transmitted.	Enable
Convert to EAN-13	Checkbox to enable converting EAN-8 to EAN-13 format.	Disable

Symbology	Description	Default
<b>UPC-E</b>		Enable
UPC-E	Switch to enable UPC-E decoding.	Enable
Addon 2	Decide whether to decode UPC-E with addon 2. <ul style="list-style-type: none"> <li>▶ Ignore Addon</li> <li>▶ Auto-discriminate</li> </ul>	Ignore Addon
Addon 5	Decide whether to decode UPC-E with addon 5. <ul style="list-style-type: none"> <li>▶ Ignore Addon</li> <li>▶ Auto-discriminate</li> </ul>	Ignore Addon
Preamble	Decide whether to include the UPC-E preamble System Character (and Country Code) in the data being transmitted. <ul style="list-style-type: none"> <li>▶ <b>No transmit:</b> transmits none of the above</li> <li>▶ <b>Transmit System Character:</b> transmits system number only</li> </ul>	Transmit System Character
Conver to UPC-A	The UPC-E barcode will be expanded into UPC-A format, and the next process will follow the settings configured for UPC-A.	Disable
Transmit Check Digit	Decide whether to include the UPC-E check digit (the last character in the barcode) in the data being transmitted.	Enable
Selection Number	System Decide whether to decode the ordinary UPC-E barcodes only or both UPC-E0 and UPC-E1 barcodes. <ul style="list-style-type: none"> <li>▶ 0 only</li> <li>▶ 0 and 1</li> </ul>	0 only
<b>Telepen</b>		Disable
Telepen	Switch to enable Telepen decoding.	Disable
<b>Plessey</b>		Disable
Plessey	Switch to enable Plessey decoding.	Disable
Transmit Check Digit	Decide whether to include the check digit in the data to transmit.	Enable
Convert UK Plessey	Decide whether to change each occurrence of the character 'A' to character 'X' in the decoded data.	Disable
<b>French Pharmacode</b>		Disable
French Pharmacode	Switch to enable French Pharmacode decoding.	Disable
Transmit Check Digit	Decide whether to include the check digit in the data to transmit.	Disable

## 2D SYMBOLOGIES

Symbology	Description	Default
<b>Aztec</b>		
<b>Aztec</b>		Enable
Aztec	Switch to enable Aztec decoding.	Enable
Decode Mirror Image	Switch to enable decode mirror images. <ul style="list-style-type: none"> <li>▶ <b>Never:</b> Does not decode Aztec barcodes that are mirror images.</li> <li>▶ <b>Always:</b> Decodes Aztec barcodes that are mirror images.</li> <li>▶ <b>Auto-discriminate:</b> Decodes both mirrored and unmirrored Aztec barcodes.</li> </ul>	Never
Inverse Type	Decide whether to disable or enable decoding inverse barcodes, or set as auto. <ul style="list-style-type: none"> <li>▶ Regular only</li> <li>▶ Inverse only</li> <li>▶ Inverse Auto-detect</li> </ul>	Regular only
<b>Data Matrix</b>		
<b>Data Matrix</b>		Enable
Data Matrix	Switch to enable Data Matrix decoding.	Enable
Decode Mirror Image	Switch to enable decode mirror images. <ul style="list-style-type: none"> <li>▶ <b>Never:</b> Does not decode Data Matrix barcodes that are mirror images.</li> <li>▶ <b>Always:</b> Decodes Data Matrix barcodes that are mirror images.</li> <li>▶ <b>Auto-discriminate:</b> Decodes both mirrored and unmirrored Data Matrix barcodes.</li> </ul>	Never
Separator Character	Enable the function code character separator, which is used to separate data fields of variable length and application identifiers of subsequent data fields in concatenated data strings.	None
Enable App ID Separator	Check to enable the separator configuration for Application Identifier. You can respectively set the <b>Left Separator</b> and <b>Right Separator</b> . Tap on  to choose your input method between Keyboard input and Symbol table input to set a separator character to replace with.	Disable
Inverse Type	Decide whether to disable or enable decoding inverse barcodes, or set as auto. <ul style="list-style-type: none"> <li>▶ Regular only</li> <li>▶ Inverse only</li> <li>▶ Inverse Auto-detect</li> </ul>	Regular only



Symbology	Description	Default
<b>MaxiCode</b>		
<b>MaxiCode</b>		Enable
MaxiCode	Switch to enable MaxiCode decoding.	Enable
<b>MicroPDF417</b>		
<b>MicroPDF417</b>		Disable
MicroPDF417	Switch to enable MicroPDF417 decoding.	Disable
<b>MicroQR</b>		
<b>MicroQR</b>		Enable
MicroQR	Switch to enable MicroQR decoding.	Enable
<b>PDF417</b>		
<b>PDF417</b>		Enable
PDF417	Switch to enable PDF417 decoding.	Enable
<b>QR Code</b>		
<b>QR Code</b>		Enable
QR Code	Switch to enable QR Code decoding.	Enable
Decode Mirror Image	Switch to enable decode mirror images. <ul style="list-style-type: none"> <li>▶ <b>Never:</b> Does not decode QR Code that are mirror images.</li> <li>▶ <b>Always:</b> Decodes QR Code that are mirror images.</li> <li>▶ <b>Auto-discriminate:</b> Decodes both mirrored and unmirrored QR Code.</li> </ul>	Never
Inverse Type	Decide whether to disable or enable decoding inverse barcodes, or set as auto. <ul style="list-style-type: none"> <li>▶ Regular only</li> <li>▶ Inverse only</li> <li>▶ Inverse Auto-detect</li> </ul>	Regular only
<b>Hanxin</b>		
<b>Hanxin</b>		Enable
Hanxin	Switch to enable Hanxin decoding.	Enable

## APPENDIX III

---

### OPEN SOURCE LICENSE

The Reader Config involves the Android-serialport-api project of Apache License Version 2.0, January 2004.

<http://www.apache.org/licenses/>

#### TERMS AND CONDITIONS FOR USE, REPRODUCTION, AND DISTRIBUTION

##### 1. Definitions.

"License" shall mean the terms and conditions for use, reproduction, and distribution as defined by Sections 1 through 9 of this document.

"Licensor" shall mean the copyright owner or entity authorized by the copyright owner that is granting the License.

"Legal Entity" shall mean the union of the acting entity and all other entities that control, are controlled by, or are under common control with that entity. For the purposes of this definition, "control" means (i) the power, direct or indirect, to cause the direction or management of such entity, whether by contract or otherwise, or (ii) ownership of fifty percent (50%) or more of the outstanding shares, or (iii) beneficial ownership of such entity.

"You" (or "Your") shall mean an individual or Legal Entity exercising permissions granted by this License.

"Source" form shall mean the preferred form for making modifications, including but not limited to software source code, documentation source, and configuration files.

"Object" form shall mean any form resulting from mechanical transformation or translation of a Source form, including but not limited to compiled object code, generated documentation, and conversions to other media types.

"Work" shall mean the work of authorship, whether in Source or Object form, made available under the License, as indicated by a copyright notice that is included in or attached to the work (an example is provided in the Appendix below).

"Derivative Works" shall mean any work, whether in Source or Object form, that is based on (or derived from) the Work and for which the editorial revisions, annotations, elaborations, or other modifications represent, as a whole, an original work of authorship. For the purposes of this License, Derivative Works shall not include works that remain separable from, or merely link (or bind by name) to the interfaces of, the Work and Derivative Works thereof.

"Contribution" shall mean any work of authorship, including the original version of the Work and any modifications or additions to that Work or Derivative Works thereof, that is intentionally submitted to Licensor for inclusion in the Work by the copyright owner or by an individual or Legal Entity authorized to submit on behalf of the copyright owner. For the purposes of this definition, "submitted" means any form of electronic, verbal, or written communication sent to the Licensor or its representatives, including but not limited to communication on electronic mailing lists, source code control systems, and issue tracking systems that are managed by, or on behalf of, the Licensor for the purpose of discussing and improving the Work, but excluding communication that is conspicuously marked or otherwise designated in writing by the copyright owner as "Not a Contribution."

"Contributor" shall mean Licensor and any individual or Legal Entity on behalf of whom a Contribution has been received by Licensor and subsequently incorporated within the Work.

2. Grant of Copyright License. Subject to the terms and conditions of this License, each Contributor hereby grants to You a perpetual, worldwide, non-exclusive, no-charge, royalty-free, irrevocable copyright license to reproduce, prepare Derivative Works of, publicly display, publicly perform, sublicense, and distribute the Work and such Derivative Works in Source or Object form.

3. Grant of Patent License. Subject to the terms and conditions of this License, each Contributor hereby grants to You a perpetual, worldwide, non-exclusive, no-charge, royalty-free, irrevocable (except as stated in this section) patent license to make, have made, use, offer to sell, sell, import, and otherwise transfer the Work, where such license applies only to those patent claims licensable by such Contributor that are necessarily infringed by their Contribution(s) alone or by combination of their Contribution(s) with the Work to which such Contribution(s) was submitted. If You institute patent litigation against any entity (including a cross-claim or counterclaim in a lawsuit) alleging that the Work or a Contribution incorporated within the Work constitutes direct or contributory patent infringement, then any patent licenses granted to You under this License for that Work shall terminate as of the date such litigation is filed.

4. Redistribution. You may reproduce and distribute copies of the Work or Derivative Works thereof in any medium, with or without modifications, and in Source or Object form, provided that You meet the following conditions:

- a. You must give any other recipients of the Work or Derivative Works a copy of this License; and
- b. You must cause any modified files to carry prominent notices stating that You changed the files; and

c. You must retain, in the Source form of any Derivative Works that You distribute, all copyright, patent, trademark, and attribution notices from the Source form of the Work, excluding those notices that do not pertain to any part of the Derivative Works; and

d. If the Work includes a "NOTICE" text file as part of its distribution, then any Derivative Works that You distribute must include a readable copy of the attribution notices contained within such NOTICE file, excluding those notices that do not pertain to any part of the Derivative Works, in at least one of the following places: within a NOTICE text file distributed as part of the Derivative Works; within the Source form or documentation, if provided along with the Derivative Works; or, within a display generated by the Derivative Works, if and wherever such third-party notices normally appear. The contents of the NOTICE file are for informational purposes only and do not modify the License. You may add Your own attribution notices within Derivative Works that You distribute, alongside or as an addendum to the NOTICE text from the Work, provided that such additional attribution notices cannot be construed as modifying the License.

You may add Your own copyright statement to Your modifications and may provide additional or different license terms and conditions for use, reproduction, or distribution of Your modifications, or for any such Derivative Works as a whole, provided Your use, reproduction, and distribution of the Work otherwise complies with the conditions stated in this License.

5. Submission of Contributions. Unless You explicitly state otherwise, any Contribution intentionally submitted for inclusion in the Work by You to the Licensor shall be under the terms and conditions of this License, without any additional terms or conditions. Notwithstanding the above, nothing herein shall supersede or modify the terms of any separate license agreement you may have executed with Licensor regarding such Contributions.

6. Trademarks. This License does not grant permission to use the trade names, trademarks, service marks, or product names of the Licensor, except as required for reasonable and customary use in describing the origin of the Work and reproducing the content of the NOTICE file.

7. Disclaimer of Warranty. Unless required by applicable law or agreed to in writing, Licensor provides the Work (and each Contributor provides its Contributions) on an "AS IS" BASIS, WITHOUT WARRANTIES OR CONDITIONS OF ANY KIND, either express or implied, including, without limitation, any warranties or conditions of TITLE, NON-INFRINGEMENT, MERCHANTABILITY, or FITNESS FOR A PARTICULAR PURPOSE. You are solely responsible for determining the appropriateness of using or redistributing the Work and assume any risks associated with Your exercise of permissions under this License.

8. Limitation of Liability. In no event and under no legal theory, whether in tort (including negligence), contract, or otherwise, unless required by applicable law (such as deliberate and grossly negligent acts) or agreed to in writing, shall any Contributor be liable to You for damages, including any direct, indirect, special, incidental, or consequential damages of any character arising as a result of this License or out of the use or inability to use the Work (including but not limited to damages for loss of goodwill, work stoppage, computer failure or malfunction, or any and all other commercial damages or losses), even if such Contributor has been advised of the possibility of such damages.

9. Accepting Warranty or Additional Liability. While redistributing the Work or Derivative Works thereof, You may choose to offer, and charge a fee for, acceptance of support, warranty, indemnity, or other liability obligations and/or rights consistent with this License. However, in accepting such obligations, You may act only on Your own behalf and on Your sole responsibility, not on behalf of any other Contributor, and only if You agree to indemnify, defend, and hold each Contributor harmless for any liability incurred by, or claims asserted against, such Contributor by reason of your accepting any such warranty or additional liability.

END OF TERMS AND CONDITIONS