

M-USB232 Intelligent USB to Serial Multi-Ports Hub User's Guide

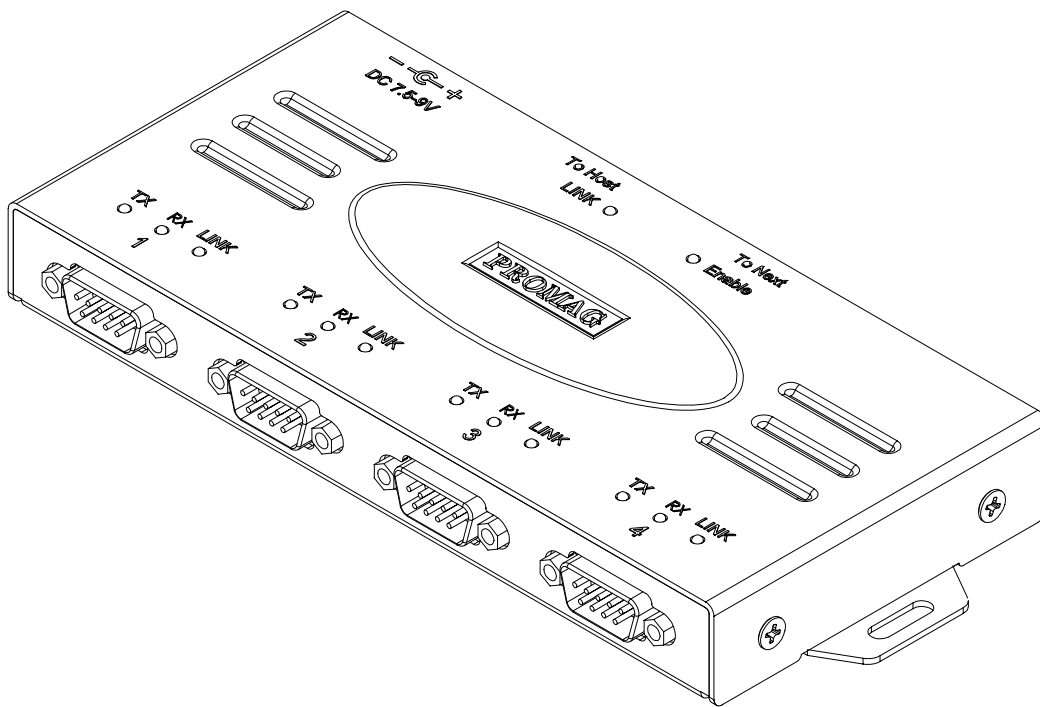

General

Thank you for purchasing the M-USB232 Intelligent USB to Serial Multi-Ports Hub. It is designed for the people who are looking for an easy-to-use solution for the application of 4 serial devices connected to one USB port. Connect M-USB232 into USB port of the computer, then the computer has 4 serial ports available for use. Eliminating the need to open the computer case to install any interface board or controller board. No further configuration is needed, just plug and play. It is a low cost and easy-to-use solution for the need of multiple serial ports.

Features

1. USB connection with speed up to 12Mbps.
2. Complete flow control, data won't be lost.
3. No need to open computer case for installation.
4. Plug and play, no further configuration needed.
5. Built-in surge protection ($\pm 15\text{KV}$ ESD, $\pm 15\text{KV}$ EFT).
6. Expandable up to 4 sets of M-USB232 (Up to 16 Serial ports for Win98 O.S).
7. Support full RS-232 function, Modem can also be connected with M-USB232.
8. Metal enclosure, durable and reliable.

Specifications

Power Requirement :

Bus power mode ----- DC 5V/500mA

Self power mode ----- DC 7.5~9V min 500mA (External power adaptor)

Communication of RS232 interface:

Baud rate ----- 300~240kbps

Parity ----- Odd/Even/None/Mark/Space

Data bit ----- 5/6/7/8bits

Stop bit ----- 1/2/1.5bits

Supply Current from RS232 Pin:

DTR: 50mA(+5Vdc) The other pin except SG: Max.10mA

Dimension :

L x W x H : 170mm x 80mm x 22mm

Environment:

Operating: 0°C to 50°C / 10 to 85% humidity, non condensing

Storage: -20°C to 75°C / 10 to 90% humidity, non condensing

Package

Make sure all the following things are contained in your package:

1. USB cable (WAS-1522).
2. Driver disc (Disk 5153).
3. M-USB232 device.
4. Accessory bag for M-USB232

Remark:

External power adaptor is an optional item, External power supply is need only when you want to expand more units of M-USB232.

Part assignment

The part assignment of the M-USB232 is as following:

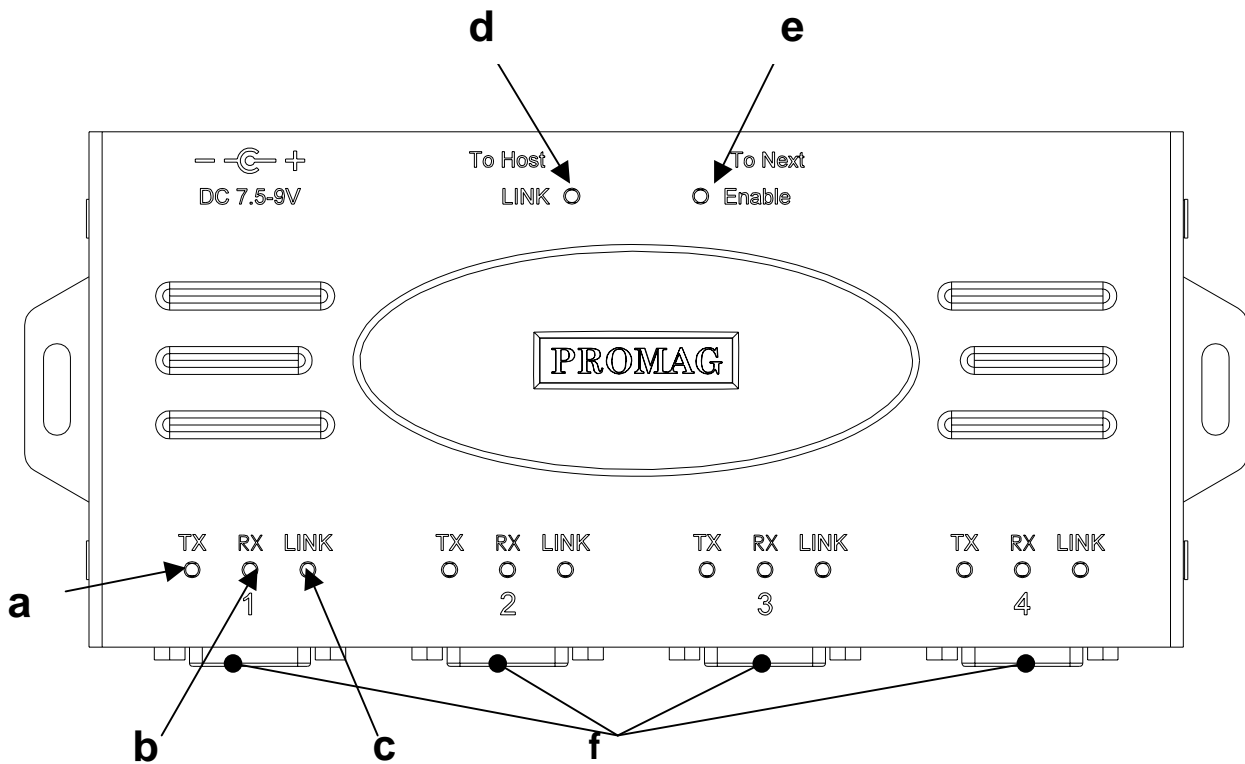

- a. TX LED b. RX LED c. LINK LED d. Host LINK LED
e. Next Enable LED f. Serial port 1/2/3/4 DB-9 connector

Figure A. The front panel of the M-USB232

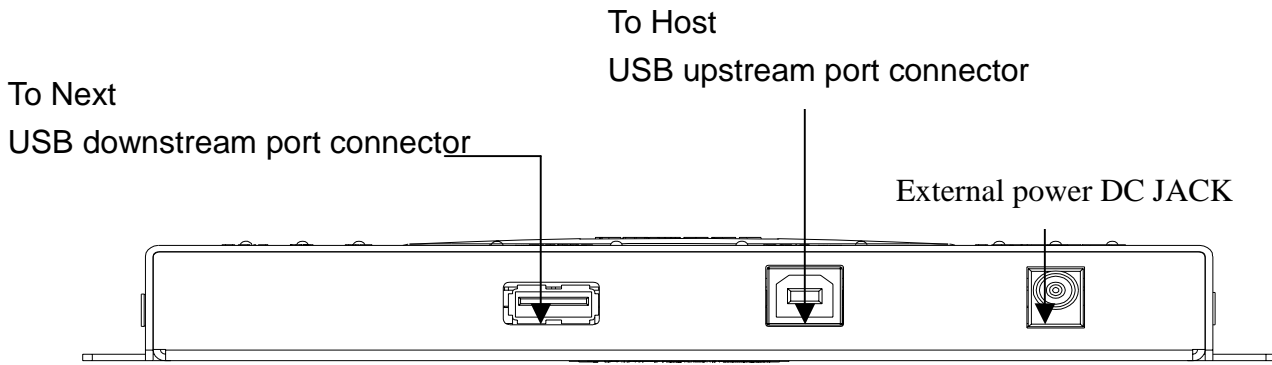

Figure B. The rear panel of the M-USB232

Functions description

- **LED Status display**

The detail of LED Status display function of the M-USB232 is shown as following table:

LED Function

LED name	Description
Host LINK	On: The M-USB232 is linked with the host computer Off: The M-USB232 is not linked with the host computer.
Next Enable	On: The USB downstream port is enabled. Off: The USB downstream port is disabled.
TX	Blink: Serial port1/2/3/4 transferring data to serial device. Off: No data transferred from serial port1/2/3/4.
RX	Blink: Serial Port1/2/3/4 receiving data from serial device. Off: No data received by serial port1/2/3/4.
Link	On: serial port1/2/3/4 is active. Off: serial port1/2/3/4 is inactive.

● **DB-9 Connector pin assignment**

The DB-9 connector pin assignment of the M-USB232 is shown as following :

- | | | |
|---------|--------------|--------|
| 1 : DCD | 5 : SG (GND) | 9 : RI |
| 2 : RXD | 6 : DSR | |
| 3 : TXD | 7 : RTS | |
| 4 : DTR | 8 : CTS | |

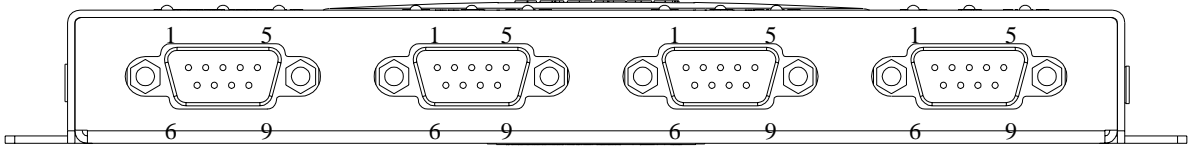

Figure C. The DB-9 Connector pin assignment of the M-USB232

Operation modes of the M-USB232

The M-USB232 supports both bus-powered (power from host computer) and self-powered (power from external power supply) modes as the same as a generic USB Hub. In bus-powered mode, the M-USB232 is powered by USB bus via an USB A/B plug cable. Serial port 1~4 is active after the M-USB232 is linked with the host computer. The USB downstream port is powered off so that user can't expand more serial port in this mode (see Figure D). Only one unit of M-USB232 can be used with bus-powered connection.

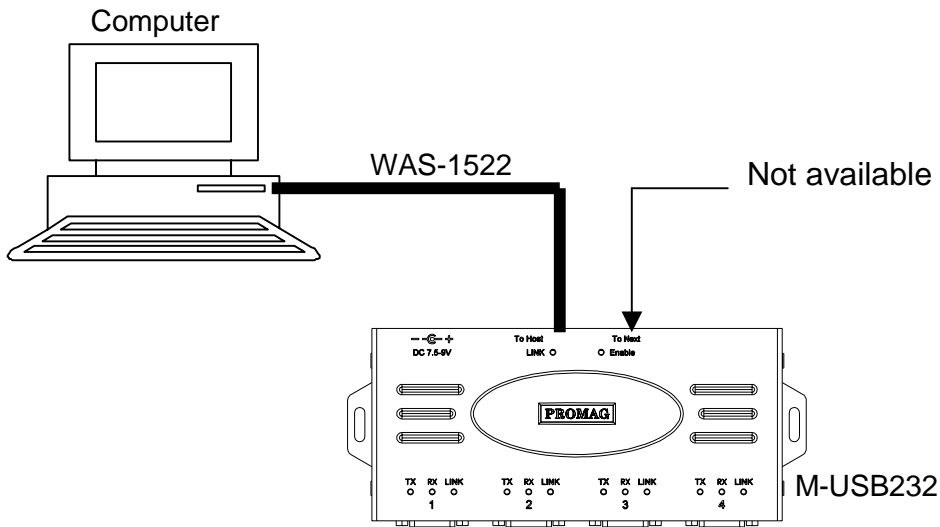

Figure D. The bus-powered mode of the M-USB232

In self-powered mode, the M-USB232 is powered by external power source ,for instance a power adaptor. Serial port1~4 is active after the M-USB232 is linked with the host computer. The USB downstream port is enabled so that user can expand more serial ports in this mode (see Figure E).

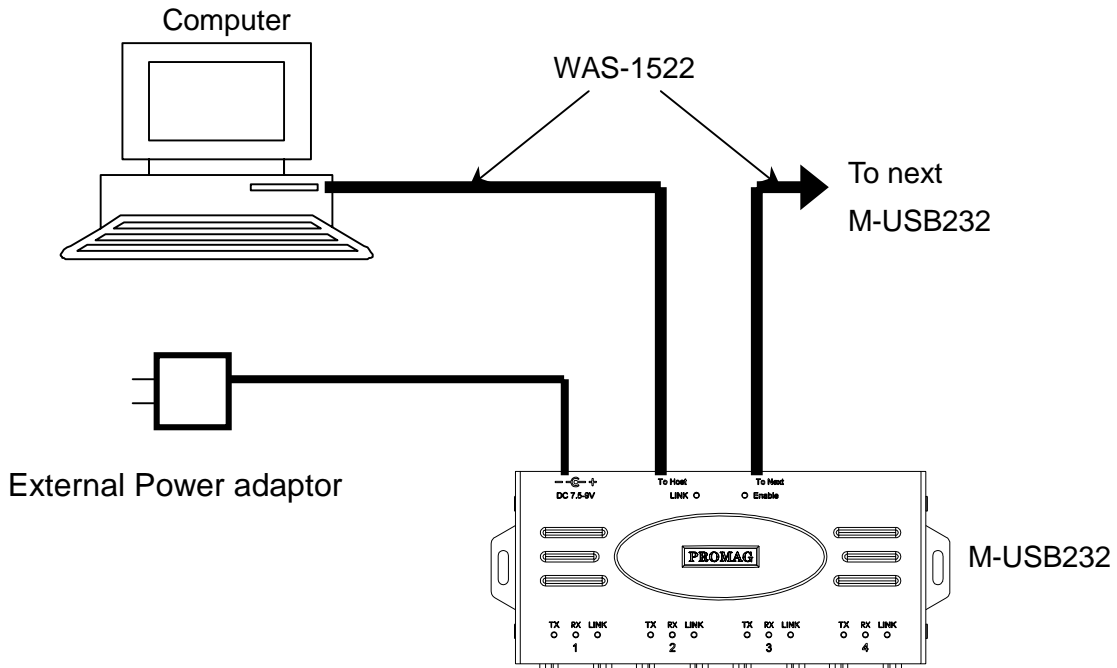

Figure E. The self-powered mode of the M-USB232

Installation

It's easy to install the M-USB232 , just follow the steps below.

1. Plug-In M-USB232 to Computer Root USB port or USB HUB with HUB external power.
2. Start your computer with O.S.(Win98SE/2000/ME/XP)
3. Put the Disk 5153 driver disc into floppy disc drive then click "Next" button twice on the screen after the computer shows you an USB device detected.
4. Specify the correct driver folder on the Disk 5153 , determined by your computer O.S. then click "Next" button on the screen.
5. Click "Next" button on the screen after the computer shows you that Windows driver file search for the device is PROMAG USB232/422/485.
6. Click "Finish" button on the screen after the computer shows you Windows has finished installing the software that your new hardware device requires.
7. Make sure there are 4 PROMAG USB232/422/485 devices appeared at the Ports (COM & LPT) on the "Device Manager" tab of the "System Properties" window.

Removing

To remove the M-USB232, please follow the steps below.

1. Put the Disk 5153 into floppy disc drive of the computer.
2. Execute "A:\Remove\Uninstall.exe" program .
3. Click "OK" button on the screen after the computer shows you the "USB-Serial Driver Remover" window.
4. Click "No" button on the screen after the computer shows you the warning window.
5. Click "Exit" button on the screen after the computer shows you "Remove driver successfully! ".

Connection of M-USB232

Windows 98 – Expand Up to 4 sets of M-USB232 for 16 serial ports.

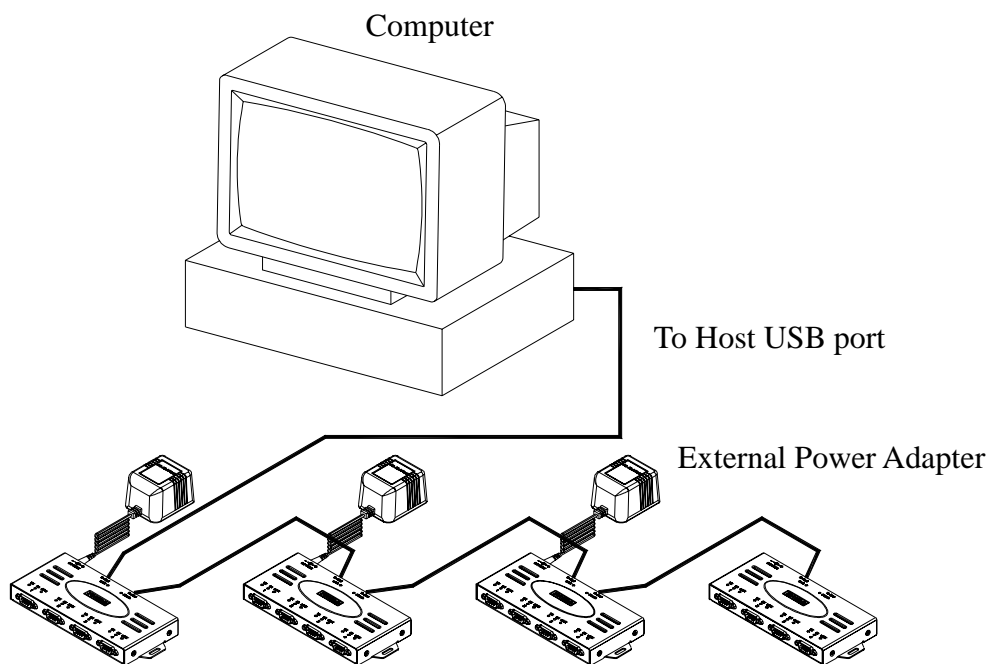

Windows 2000 –Expand Up to 32 sets of M-USB232 for 128 serial ports