

CipherLab Reference Manual

8500 Series Mobile Computer

8500/8570

Version 2.21



Copyright © 2006~2011 CIPHERLAB CO., LTD.
All rights reserved

The software contains proprietary information of CIPHERLAB CO., LTD.; it is provided under a license agreement containing restrictions on use and disclosure and is also protected by copyright law. Reverse engineering of the software is prohibited.

Due to continued product development this information may change without notice. The information and intellectual property contained herein is confidential between CIPHERLAB and the client and remains the exclusive property of CIPHERLAB CO., LTD. If you find any problems in the documentation, please report them to us in writing. CIPHERLAB does not warrant that this document is error-free.

No part of this publication may be reproduced, stored in a retrieval system, or transmitted in any form or by any means, electronic, mechanical, photocopying, recording or otherwise without the prior written permission of CIPHERLAB CO., LTD.

For product consultancy and technical support, please contact your local sales representative. Also, you may visit our web site for more information.

The CipherLab logo is a registered trademark of CIPHERLAB CO., LTD.

All brand, product and service, and trademark names are the property of their registered owners.

The editorial use of these names is for identification as well as to the benefit of the owners, with no intention of infringement.

CIPHERLAB CO., LTD.

Website: <http://www.cipherlab.com>

IMPORTANT NOTICES

FOR USA

This equipment has been tested and found to comply with the limits for a **Class B** digital device, pursuant to Part 15 of the FCC Rules. These limits are designed to provide reasonable protection against harmful interference in a residential installation. This equipment generates, uses and can radiate radio frequency energy and, if not installed and used in accordance with the instructions, may cause harmful interference to radio communications. However, there is no guarantee that interference will not occur in a particular installation. If this equipment does cause harmful interference to radio or television reception, which can be determined by turning the equipment off and on, the user is encouraged to try to correct the interference by one or more of the following measures:

- ▶ Reorient or relocate the receiving antenna.
- ▶ Increase the separation between the equipment and receiver.
- ▶ Connect the equipment into an outlet on a circuit different from that to which the receiver is connected.
- ▶ Consult the dealer or an experienced radio/TV technician for help.

This device complies with Part 15 of the FCC Rules. Operation is subject to the following two conditions: (1) This device may not cause harmful interference, and (2) this device must accept any interference received, including interference that may cause undesired operation.

FOR CANADA

This digital apparatus does not exceed the Class B limits for radio noise emissions from digital apparatus as set out in the interference-causing equipment standard entitled "Digital Apparatus," ICES-003 of Industry Canada.

This device complies with Part 15 of the FCC Rules. Operation is subject to the following two conditions: (1) This device may not cause harmful interference, and (2) this device must accept any interference received, including interference that may cause undesired operation.

Cet appareil numérique respecte les limites de bruits radioélectriques applicables aux appareils numériques de Classe B prescrites dans la norme sur le matériel brouilleur: "Appareils Numériques," NMB-003 édictée par l'Industrie.

FOR HAND-HELD PRODUCT WITH RF FUNCTIONS

This equipment complies with FCC radiation exposure limits set forth for an uncontrolled environment. This equipment should be installed and operated with minimum distance 20 cm between the radiator & your body. It only operated in hand-held used.

If you only transfer data to the host wirelessly, please keep the minimum distance 20 cm between machine & your body.

FOR PRODUCT WITH LASER



CAUTION

This laser component emits FDA / IEC Class 2 laser light at the exit port. Do not stare into beam.

SAFETY PRECAUTIONS

RISK OF EXPLOSION IF BATTERY IS REPLACED BY AN INCORRECT TYPE. DISPOSE OF USED BATTERIES ACCORDING TO THE INSTRUCTIONS.

- ▶ The use of any batteries or charging devices, which are not originally sold or manufactured by CipherLab, will void your warranty and may cause damage to human body or the product itself.
- ▶ DO NOT disassemble, incinerate or short circuit the battery.
- ▶ DO NOT expose the scanner or the battery to any flammable sources.
- ▶ For green-environment issue, it's important that batteries should be recycled in a proper way.
- ▶ Under no circumstances, internal components are self-serviceable.
- ▶ The charging and communication cradle uses an AC power adaptor. A socket outlet shall be installed near the equipment and shall be easily accessible. Make sure there is stable power supply for the mobile computer or its peripherals to operate properly.

CARE & MAINTENANCE

- ▶ This mobile computer is intended for industrial logistics use. The mobile computer is rated IP 64, however, it may do damage to the mobile computer when being exposed to extreme temperatures or soaked wet.
- ▶ When the body of the mobile computer gets dirty, use a clean and wet cloth to wipe off the dust. DO NOT use/mix any bleach or cleaner. Always keep the LCD dry.
- ▶ For a liquid crystal display (LCD) or touch screen, use a clean, non-abrasive, lint-free cloth to wipe dust off the screen. DO NOT use any pointed or sharp object to move against the surface.
- ▶ If you want to put away the mobile computer for a period of time, download the collected data to a host computer, and then take out the battery pack. Store the mobile computer and battery pack separately.
- ▶ When the mobile computer resumes its work, the main and backup batteries will take a certain time to become fully charged.
- ▶ If you shall find the mobile computer malfunctioning, write down the specific scenario and consult your local sales representative.

RELEASE NOTES

| Version | Date | Notes |
|---------|---------------|--|
| 2.21 | Mar. 09, 2011 | <ul style="list-style-type: none">▶ Modified: 3.7 Bluetooth Menu — Not maintain Bluetooth PAN (=BNEP) from 2011▶ Modified: Specifications — add power adaptor spec. |
| 2.20 | Oct. 28, 2010 | <ul style="list-style-type: none">▶ New: Appendix III Key Reference Tables▶ Modified: Remove support of 8580/8590▶ Modified: 1.6.1 Symbologies Supported — ISBT 128 enabled by default and UPC/EAN Addon 2 & 5 disabled by default; add more GS1 DataBar symbologies▶ Modified: 3.7 Bluetooth Menu — update table (add HID)▶ Modified: 3.7.4 Echo Tests — Add "HID Test"▶ Modified: 3.7.5 Pairing Test — Max. 11 characters for device name▶ Modified: 3.7.6 Freq. Dev. List — Max. 11 characters for device name▶ Modified: 3.10.3 WLAN Setting — Add "Fixed BSSID"▶ Modified: Specifications — 70 hours working time in Wi-Fi mode |
| 2.12 | May 20, 2009 | <ul style="list-style-type: none">▶ Modified: 1.3.2 24-key Layout — Press the Alpha key once to input capital letters▶ Modified: 4.1.1 Download — [C], [D] are case-sensitive |
| 2.11 | July 21, 2008 | <ul style="list-style-type: none">▶ Modified: 1.3.3 44-key Keypad — "59-key" corrected to "44-key" |
| 2.10 | Apr. 24, 2008 | New Word template applied |
| 2.01 | Aug. 10, 2007 | <ul style="list-style-type: none">▶ Modified: 1.5.9 Reader — Defaults updated▶ Modified: 4.1.8.(4) GSM/GPRS Menu > Security▶ Modified: 4.1.8.(4) GSM/GPRS Menu > GPRS Settings |
| 2.00 | May 19, 2007 | <ul style="list-style-type: none">▶ New release |
| 1.07 | Oct. 31, 2006 | <ul style="list-style-type: none">▶ Modified: 1.5.9 List by standards for RFID tags▶ Modified: 1.5.10 Bluetooth specification▶ Modified: 4.1.7 Bluetooth Menu > Security — max. 16 characters for PIN |
| 1.06 | July 27, 2006 | <ul style="list-style-type: none">▶ Modified: 1.3.9 Reader — RFID (add ICODE)▶ Modified: 2.5.2 Front Panel (LEDs of cradle)▶ New: 4.1.8(2) System Menu > IR Network Menu |
| 1.05 | June 22, 2006 | <ul style="list-style-type: none">▶ Modified: 1.3.9 Reader — RFID▶ Modified: 4.1.1 Information — add RFID version |
| 1.04 | June 16, 2006 | <ul style="list-style-type: none">▶ FCC Regulations — Class B statement▶ Modified: 1.3.9 Reader — Symbologies Supported & Enabled |

- | | | |
|------|---------------|---|
| 1.03 | May 23, 2006 | Company name changed to CIPHERLAB CO., LTD. since April 2006 <ul style="list-style-type: none">▶ New: Safety Precaution▶ Modified: Care & Maintenance▶ Modified: 1.2.3 Dimensions & Specifications▶ Modified: 1.3.4 Keypad – Screen Icons▶ Modified: 1.3.5 LCD – Screen & Backlight Settings▶ Modified: 1.3.12 Application Software to include AG and CipherNet▶ Modified: 2, 2.5 ~ 2.7▶ Modified: 3.1 & 3.3▶ Modified: 4.1.2 Screen Calibration▶ Modified: 4.1.6 Load Program via Bluetooth |
| 1.02 | Apr. 04, 2006 | <ul style="list-style-type: none">▶ Update drawings▶ Load Program via Bluetooth |
| 1.00 | Mar. 01, 2006 | Initial release |

CONTENTS

| | |
|---|--------------|
| IMPORTANT NOTICES | - 3 - |
| For USA | - 3 - |
| For Canada | - 3 - |
| For Hand-held Product with RF Functions | - 3 - |
| For Product with Laser | - 4 - |
| Safety Precautions | - 4 - |
| Care & Maintenance | - 4 - |
| RELEASE NOTES | - 5 - |
| INTRODUCTION | 1 |
| Getting Familiarized with 8500 | 2 |
| Features | 3 |
| Inside the Package | 3 |
| Accessories | 4 |
| Getting Started | 5 |
| Installing Hand Strap | 5 |
| Installing Pistol Grip | 6 |
| Inserting Battery | 7 |
| Initial Charging | 8 |
| Setting Local Time | 8 |
| Power Management | 8 |
| USING 8500 MOBILE COMPUTER | 9 |
| 1.1 Battery | 9 |
| 1.1.1 Main Battery | 9 |
| 1.1.2 Backup Battery | 10 |
| 1.1.3 Caution of Low Battery Charge | 10 |
| 1.2 Memory | 11 |
| 1.2.1 Read-only Memory (ROM) | 11 |
| 1.2.2 Random-access Memory (RAM) | 11 |
| 1.2.3 Upgradeable Memory | 11 |
| 1.3 Keypad | 12 |
| 1.3.1 24-key Layout | 12 |
| 1.3.2 44-key Layout | 16 |
| 1.3.3 44-TE key Layout | 19 |
| 1.4 LCD | 23 |
| 1.4.1 Adjusting the Backlight | 23 |
| 1.4.2 Calibrating the Screen | 24 |
| 1.5 Notifications | 25 |
| 1.5.1 Status LED | 25 |
| 1.5.2 Audio | 25 |
| 1.5.3 Vibrator | 25 |
| 1.6 Data Capture | 26 |

| | |
|--|-----------|
| 1.6.1 Symbolologies Supported | 26 |
| 1.6.2 RFID Tags Supported | 28 |
| 1.7 Charging & Communications | 29 |
| 1.7.1 Cradle Options | 29 |
| 1.7.2 Understanding the LED Indicators | 33 |
| 1.7.3 4-Slot Battery Charger | 34 |
| LEARNING SOFTWARE ARCHITECTURE..... | 35 |
| 2.1 Application Module..... | 37 |
| 2.1.1 FORGE Application Generator (AG) | 37 |
| 2.1.2 MIRROR Emulator (CipherNet) | 38 |
| 2.1.3 User Program..... | 38 |
| 2.2 System Configuration & Core..... | 39 |
| 2.2.1 System Menu..... | 39 |
| 2.2.2 Kernel | 39 |
| 2.2.3 Program Manager | 39 |
| SYSTEM MENU..... | 41 |
| 3.1 Information..... | 42 |
| 3.1.1 Understanding Device Code | 43 |
| 3.2 Settings | 44 |
| 3.2.1 Clock | 44 |
| 3.2.2 Backlight Period | 44 |
| 3.2.3 Auto Off | 44 |
| 3.2.4 Power On Options..... | 45 |
| 3.2.5 Key Click | 45 |
| 3.2.6 System Password | 45 |
| 3.2.7 Font | 45 |
| 3.2.8 Screen Calibration..... | 45 |
| 3.2.9 Reset to Default | 45 |
| 3.2.10 Reset Reader | 46 |
| 3.2.11 LCD Heater | 46 |
| 3.3 Tests | 47 |
| 3.3.1 Reader | 47 |
| 3.3.2 Buzzer | 47 |
| 3.3.3 LCD & LED | 47 |
| 3.3.4 Keyboard..... | 47 |
| 3.3.5 Memory | 47 |
| 3.3.6 Touch Screen..... | 48 |
| 3.3.7 Vibrator | 48 |
| 3.3.8 Echo Test | 48 |
| 3.3.9 RFID | 48 |
| 3.4 Memory | 49 |
| 3.4.1 Size information | 49 |
| 3.4.2 Initialize..... | 49 |
| 3.5 Power..... | 50 |
| 3.6 Load Program | 51 |
| 3.7 Bluetooth Menu | 53 |
| 3.7.1 Information | 54 |
| 3.7.2 Connect Setting..... | 55 |
| 3.7.3 Security | 56 |

| | |
|--|-----------|
| 3.7.4 Echo Tests | 57 |
| 3.7.5 Pairing Test..... | 60 |
| 3.7.6 Freq. Dev. List..... | 61 |
| 3.7.7 Network Setting..... | 62 |
| 3.8 Serial PPP Menu | 63 |
| 3.8.1 Information | 63 |
| 3.8.2 Connection Set..... | 64 |
| 3.8.3 Echo Test | 65 |
| 3.9 IR Network Menu (Ethernet via IR)..... | 66 |
| 3.9.1 Information | 66 |
| 3.9.2 Network Setting..... | 67 |
| 3.9.3 Echo Tests | 68 |
| 3.10 Wi-Fi Menu | 69 |
| 3.10.1 Information..... | 70 |
| 3.10.2 Network Setting | 71 |
| 3.10.3 WLAN Setting | 72 |
| 3.10.4 Security..... | 74 |
| 3.10.5 Echo Tests..... | 75 |
| PROGRAM MANAGER & KERNEL | 79 |
| 4.1 Program Manager..... | 79 |
| 4.1.1 Download..... | 80 |
| 4.1.2 Activate | 82 |
| 4.1.3 Upload..... | 83 |
| 4.2 Kernel..... | 84 |
| 4.2.1 Kernel Information | 85 |
| 4.2.2 Load Program | 86 |
| 4.2.3 Kernel Update | 88 |
| 4.2.4 Test & Calibrate..... | 88 |
| 4.2.5 Bluetooth Menu..... | 88 |
| SPECIFICATIONS | 89 |
| DOWNLOAD UTILITY..... | 91 |
| File Types | 91 |
| Font File | 91 |
| C Programs | 91 |
| BASIC Programs | 91 |
| ProgLoad.exe | 92 |
| TROUBLESHOOTING | 93 |
| Cannot turn on when pressing Power key | 93 |
| Charging error..... | 93 |
| Buzzer seems not working..... | 93 |
| LED indicator seems not working..... | 93 |
| LCD touch screen seems not working | 93 |
| Keypad seems not working | 93 |
| Vibrator seems not working..... | 94 |
| Mobile computer seems not working..... | 94 |

- Cannot scan barcodes 94
 - Low battery condition..... 94
 - Barcode or RFID reader problem 94
- Cannot decode data after scanning..... 94
 - Unreadable barcode 94
 - Un-programmed to read 94
 - Dirty scan window 94
 - Out of scanning range..... 94
- Cannot transmit/receive data 95
 - Via IR port 95
 - Using RS-232 cable via cradle 95
 - Via Bluetooth 95
 - Via Wi-Fi 95
 - Via Ethernet Cradle 95
 - Via Modem Cradle..... 96
- KEY REFERENCE TABLES 97**
 - 24-key Keypad..... 97
 - System Defaults 97
 - 44-key Keypad..... 98
 - System Defaults 98
 - 44-TE key Keypad..... 99
 - System Defaults 99

INTRODUCTION

Answering heavy industrial demands for robust, versatile and high performance computers, the 8500 Series Mobile Computer is specifically designed for all-day, everyday use as well as for data-intensive applications in harsh environments.

This line of product comes with built-in Bluetooth technology and allows for optional modules for 802.11b/g, enabling all the time, anywhere applications and seamless real time sharing of performance.

The 8500 Series Mobile Computer is bundled with powerful and rich features to ensure success in timely processing of information, even in rigorous industrial environments, and thus, makes an ideal choice for a wireless solution in either increasing business flexibility or answering the demanding needs of heavy-duty mobile computers. Being programmable, this handy device can run custom applications or terminal emulation applications.

This manual serves to guide you through how to install, configure, and operate the mobile computer. We recommend you to keep one copy of the manual at hand for quick reference or maintenance purposes. To avoid any improper disposal or operation, please read the manual thoroughly before use.

Thank you for choosing CipherLab products!

GETTING FAMILIARIZED WITH 8500



Figure 1: Overview

| No. | Description | No. | Description |
|-----|----------------------------|-----|---|
| 1 | LCD touch screen | 2 | LED for Good Read and battery charging |
| 3 | Keypad, 24 or 44 keys | 4 | Communication/charging port |
| 5 | Stylus | 6 | Scanning window |
| 7 | Hand strap (to be screwed) | 8 | Pistol Grip, optional (to be screwed after removal of this cover) |
| 9 | Battery Latch | 10 | Li-ion Battery, fit to compartment |

Warning: Always make sure the hand strap is well hooked and screwed to the back of the mobile computer before use.

FEATURES

- ▶ Ergonomic design — ruggedized yet streamlined, with hand strap for secure hold
- ▶ Built tough to survive drop test and sealed against moisture/dust to IP 64
- ▶ Upgradeable memory — adds up to 10 MB (2 MB onboard + 8 MB) for data storage
- ▶ Dual mode support — one barcode scan engine plus the RFID reader
- ▶ Flexible wireless solutions — IR/IrDA and Bluetooth integrated, with connectivity options for 802.11b/g
- ▶ Large graphic monochrome LCD touch screen supports double-byte characters and bitmap graphics. The touch screen featuring signature capture can be activated with its stylus or a finger, software programmable
- ▶ Programmable feedback includes buzzer, LED indicator, and vibrator
- ▶ Quick link to any backend database through MIRROR Emulator programs for VT100/220 and IBM 5250 emulation
- ▶ Easy customization of data collection applications through FORGE Application Generator (AG) programs for preloaded AG Runtime, batch and WLAN versions available
- ▶ Programming support includes BASIC & C compilers
- ▶ Accessories include pistol grip, 4-Slot Battery Charger and a variety of charging/communications cradle, etc.

INSIDE THE PACKAGE

The following items are included in the package. Save the box and packaging material for future use in case you need to store or ship the mobile computer.

- ▶ 8500 Series mobile computer
- ▶ Rechargeable Li-ion battery pack
- ▶ Stylus
- ▶ Hand strap
- ▶ Product CD

Note: For battery charging, you need to purchase a charging cradle separately.

ACCESSORIES

Rich choices of optional accessories are available for you to enhance the total performance of the mobile computer.

- ▶ Pistol Grip (detachable)
- ▶ Belt Holster
- ▶ Protective Cover
- ▶ Spare rechargeable Li-ion battery
- ▶ 4-slot Battery Charger
- ▶ Charging & Communication Cradle
- ▶ Modem Cradle
- ▶ Ethernet Cradle (10/100 BASE-T)
- ▶ Vehicle Cradle
- ▶ Travel Charger

GETTING STARTED

INSTALLING HAND STRAP

The hand strap is ideal for one-handed operation, which requires safe and convenient hold of the mobile computer.

Warning: Always make sure the hand strap is well hooked and screwed to the back of the mobile computer before use.

When the hand strap is desired, install it to the mobile computer by following these steps:

- 1) Place the mobile computer face down on a flat and clean surface.
- 2) Screw one end of the hand strap to the back of the mobile computer.
- 3) Insert and hook the other end of the hand strap to the bottom of the mobile computer.
- 4) Make sure the hand strap is securely attached to the mobile computer.

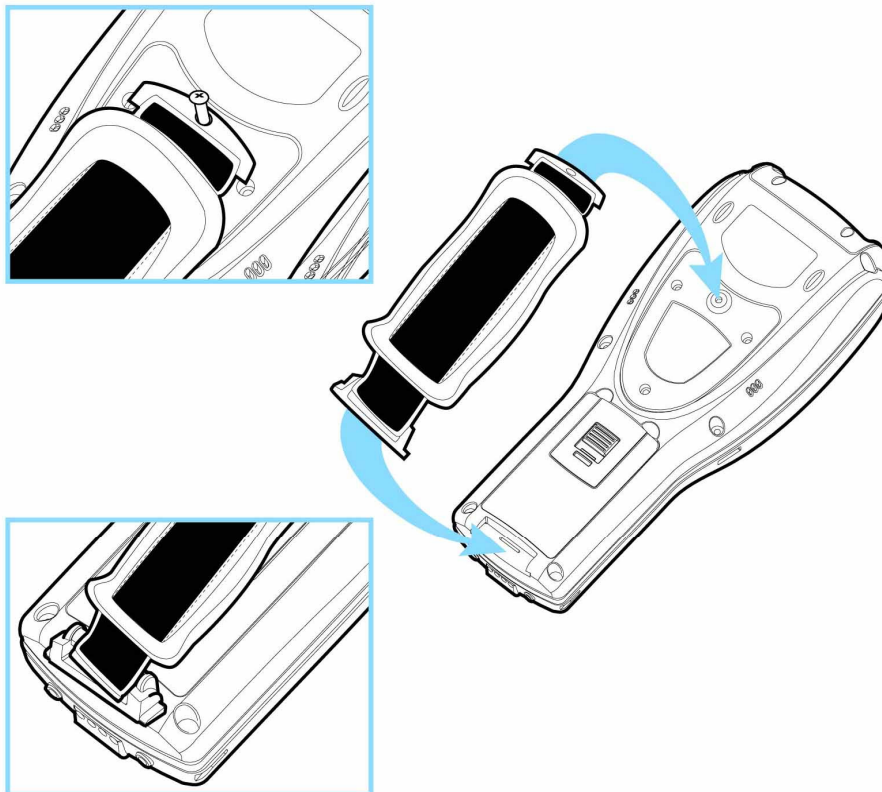

Figure 2: Installing the Hand Strap

INSTALLING PISTOL GRIP

This contoured pistol grip enables intuitive trigger-and-scan operation, which is very helpful in scan intensive applications. When the pistol grip is desired, install it to the mobile computer by following these steps:

- 1) Place the mobile computer face down on a flat and clean surface.
- 2) Remove the shield-like cover on the back of the mobile computer by unscrewing.
If the hand strap is installed, remove it first. Keep the cover and screws for future use when the pistol grip is not desired.
- 3) Connect the power connector from the pistol grip to the receptacle on the mobile computer.
- 4) Screw the pistol grip to the shield-like cover.
- 5) Make sure all screws are tightened up.
- 6) Turn on the mobile computer and test the trigger.

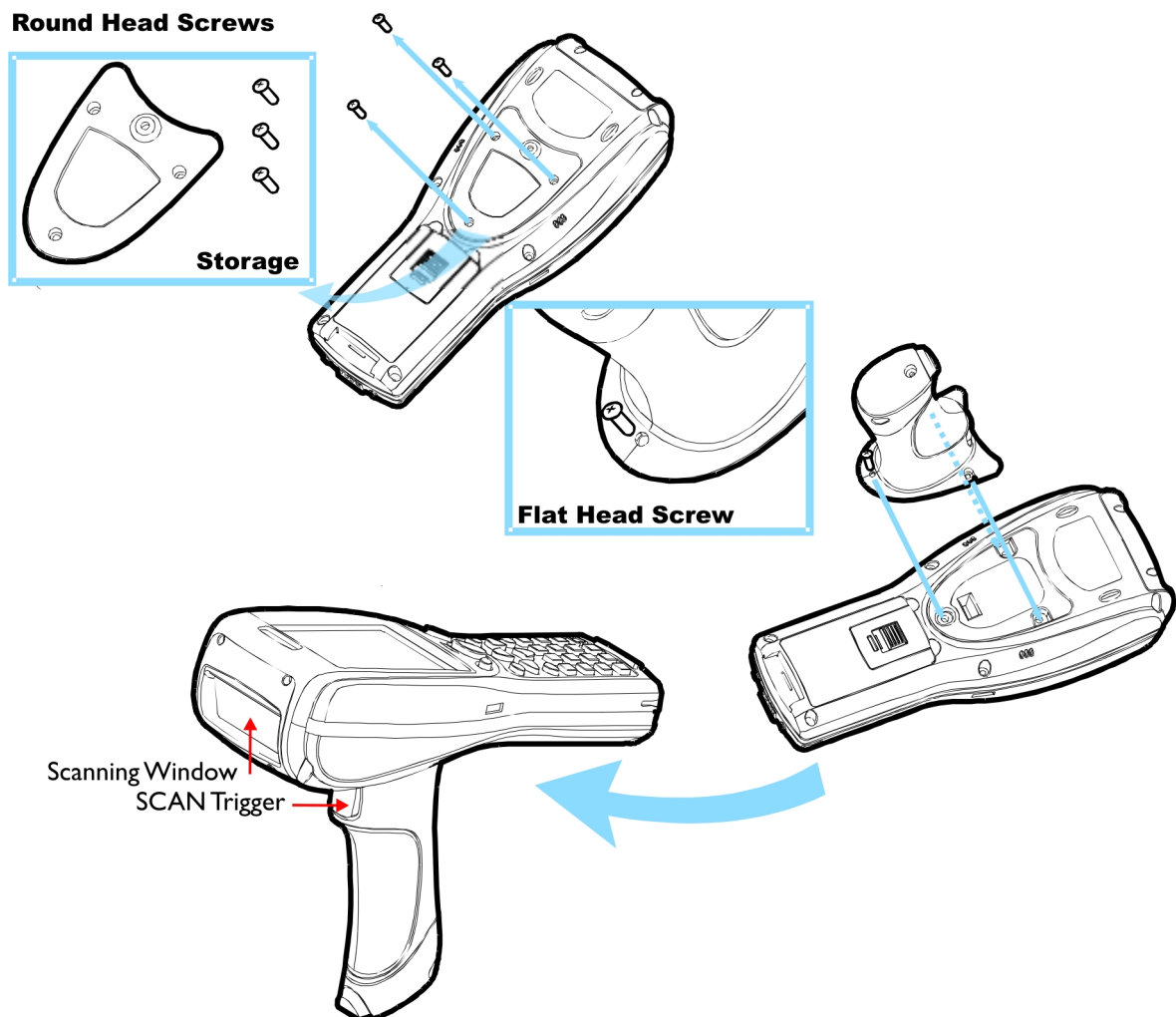

Figure 3: Installing the Pistol Grip

INSERTING BATTERY

For shipping and storage purposes, save the mobile computer and the main battery in separate packages. This will keep both batteries in good condition for future use.

Note: Any improper handling may reduce the battery life.

- 1) Hold the mobile computer still as shown below.
 - 2) Slide the battery pack into the battery compartment at a proper angle ($30^{\circ}\sim 45^{\circ}$) so that the metal contacts of the battery are met with the charging contacts inside the compartment. Make sure that the battery is snugly fit into the compartment.
 - 3) Slide the battery latch to lock the battery in the compartment.
-

Note: For a new battery, make sure it is fully charged before use. Always prepare a spare battery pack, especially when you are on the road.

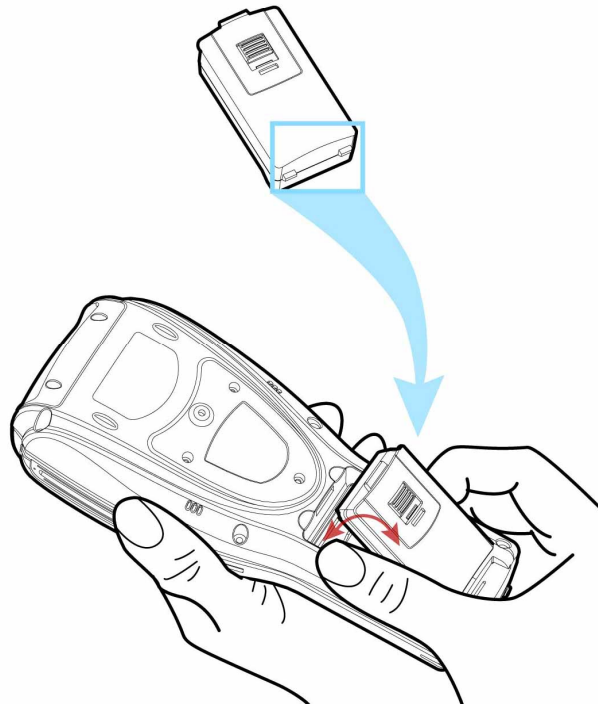

Figure 4: Installing the Main Battery

INITIAL CHARGING

The main and backup batteries may not be charged to full for shipment. When you first receive the package, you will need to charge batteries to full before using the mobile computer. You may use a cradle or charger to charge the Mobile Computer or spare batteries. Refer to [1.7 Charging & Communications](#).

Note: Battery charging stops when the temperature drops below 0°C or exceeds 40°C. It is recommended to charge the battery at room temperature (18°C to 25°C) for optimal performance. For initial charging, it takes approximately 4 hours to charge the battery to full.

Because the internal backup battery is constantly charged from the main battery, the initial charging requires inserting the battery pack to the mobile computer and then seating the mobile computer in the cradle for charging. This will have both the main and backup batteries charged at the same time. It takes at least 24 hours to fully charge the backup battery. However, it is not necessary to fully charge the backup battery for the mobile computer to work.

Note: In order to charge the backup battery to full, you must insert the main battery and leave it for at least 24 hours, whether the mobile computer is in use or not.

SETTING LOCAL TIME

If you need to set your local time, go to **System Menu | 2. Settings | 1. Clock**. Refer to [3.2.1 Clock](#).

POWER MANAGEMENT

For any portable device, power management is a critical issue especially when you are on the road. Below are some tips to help you save battery power.

Warning: Using backlight, wireless connectivity, and peripherals while on battery power will substantially reduce battery power.

- ▶ To speed up charging the mobile computer, turn off the mobile computer and seat it in the cradle.
- ▶ Bring a second battery pack on the road.
- ▶ Stop wireless connectivity, Bluetooth or 802.11b/g that is not in use.
- ▶ Go to **System Menu | 2. Settings | 2. Backlight Period**, and configure backlight period and luminosity. Refer to [3.2.2 Backlight Period](#).
- ▶ Go to **System Menu | 2. Settings | 3. Auto Off**, and configure the amount of idle time that must pass before the system will shut down automatically. Refer to [3.2.3 Auto Off](#).

USING 8500 MOBILE COMPUTER

This chapter explains the features and usage of the 8500 Series Mobile Computer. The 8500 family includes:

- ▶ 8500 Bluetooth Class 2
- ▶ 8570 Bluetooth Class 2 + 802.11b/g

IN THIS CHAPTER

| | |
|------------------------------------|----|
| 1.1 Battery..... | 9 |
| 1.2 Memory..... | 11 |
| 1.3 Keypad..... | 12 |
| 1.4 LCD | 23 |
| 1.5 Notifications..... | 25 |
| 1.6 Data Capture | 26 |
| 1.7 Charging & Communications..... | 29 |

1.1 BATTERY

1.1.1 MAIN BATTERY

The mobile computer is powered by a rechargeable 3.7 V/4000 mAh Li-ion battery pack, and it takes approx. four hours to charge it to full.

For power-saving purpose, always turn off the backlight while working in a well-lit area. When the backlight is on for extended periods of time, the main battery will become low sooner than expected.

The smart battery icon on the LCD screen shows the status of power consumption. There are two ways to monitor a low battery charge or discharged battery from the screen.

- ▶ Examine the level of the 4-bar battery icon
- ▶ Monitor voltage level (see [3.5 Power](#))

1.1.2 BACKUP BATTERY

The backup battery on the main board takes charge when the main battery is removed or drained out. When fully charged, the 3.0 V/7 mAh rechargeable Lithium button cell helps retain data in SRAM and maintain the running of the real-time clock and calendar for at least one week without the main battery. In the meantime, you have to replace the main battery as soon as possible. It takes at least twenty-four hours to fully charge the backup battery. However, it is not necessary to fully charge the backup battery for the mobile computer to work.

- ▶ Monitor voltage level (see [3.5 Power](#))

1.1.3 CAUTION OF LOW BATTERY CHARGE

The battery pack is the only power source for the mobile computer to work. It also charges the backup battery on the main board so that the data stored in SRAM can be retained properly. Therefore, when the main battery charge goes low, you need to replace the battery pack with a charged one or charge it as soon as possible. Most of all, you should upload important data on a regular basis.

Warning: Data loss may occur with SRAM during low battery condition. Always save data before running out of power or keep a fresh battery for replacement.

1.2 MEMORY

The collected data can be sent back to a host computer immediately over wireless networks, or stored in memory (SRAM) and upload later. The mobile computer is equipped with a calendar chip for accurate time/date logging. When the main battery is removed or drained, the backup battery on the main board is to retain the contents of SRAM and maintain the running of real-time clock and calendar for at least one week, on condition that the backup battery has already been fully charged.

If you want to put away the mobile computer for a couple of days, you should be aware that data loss occurs when both the main and backup batteries discharge completely. Therefore, it is necessary to upload data and files before putting away the mobile computer!

1.2.1 READ-ONLY MEMORY (ROM)

2 megabytes flash memory for storing core, OS, application programs, fonts, etc.

1.2.2 RANDOM-ACCESS MEMORY (RAM)

2 megabytes SRAM for storing data. Its contents will be retained by the backup battery.

1.2.3 UPGRADEABLE MEMORY

When ordering, you may choose to have up to 10 MB memory — 2 MB onboard + 8 MB for data storage.

- ▶ 4 or 8 MB optional

1.3 KEYPAD

The mobile computer can be equipped with a keypad of 24 keys or 44 keys for system setup, user entry and so on. The keypad comes with programmable LED backlight, like the screen. Refer to section [1.4 LCD](#) for screen & backlight settings.

Silicon rubber has been chosen for their durability and prompt feedback. The key click can be configured through programming or via **System Menu**. Refer to [3.2.5 Key Click](#).

1.3.1 24-KEY LAYOUT

The layout of the 24-key keypad is similar to that of a telephone, which includes alphanumeric, navigation and function keys, as well as assorted characters.

Refer to [Appendix III — Key Reference Tables](#).

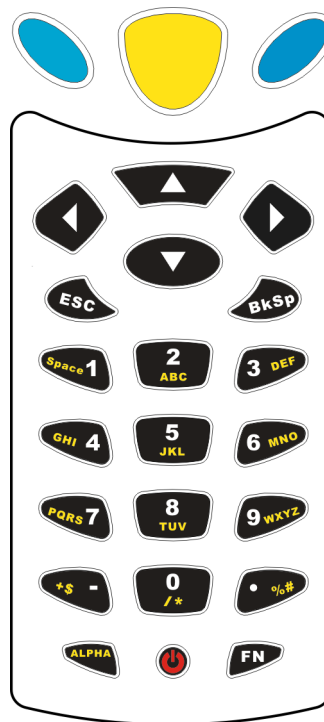



Figure 5: 24-key Layout

This alphanumeric keypad is set to numeric mode by default. The [ALPHA] key serves as a toggle among numeric, alpha (lower-case alphabetic), and ALPHA (upper-case alphabetic) input modes.

Note: It is not necessary to hold down the [ALPHA] key.

The alpha icon will appear on the lower-left corner of the screen in a sequence as shown below.

| Status Icon | Alpha Key | Input Mode |
|-------------|---|-----------------------|
| (none) | N/A | Numbers |
| A | Press  one time | Upper-case alphabetic |
| a | Press  two times | Lower-case alphabetic |



When in alpha mode, it takes turns to show alphabets and number when you keep pressing the same key; each press must not exceed one second. For example, keep pressing the number key [2], it will take turns to show "A", "B", "C" or "2" for upper-case, and "a", "b", "c" or "2" for lower-case.

- ▶ When you first press the number key [2], it will produce the letter "A" or "a".
- ▶ When you press the number key [2] twice (the time interval must not exceed one second), it will produce the letter "B" or "b".
- ▶ When you press the number key [2] three times (the time interval between each press must not exceed one second), it will produce the letter "C" or "c".
- ▶ When you press the number key [2] four times (the time interval between each press must not exceed one second), it will produce the number "2".

In order to get the desired character, you will need to press the same key, one to four times (the time interval between each press must not exceed one second). Only when you stop pressing the same key for longer than one second or you press another key, will the system send the real key code to the application program.

Yellow-coded alphabetic letter printed at the side



The [FN] key  works with a number key. Press the function key, and its associated icon  will be displayed on the screen. Press the second key, say [5], to complete the key combination and access the function [F5]. The icon  will go off automatically.

Below briefly describes the functions of common keys on the mobile computer.

SCAN



This yellow key is used to trigger the scan engine so that it can read a barcode when the reader function is enabled.

ENTER



The two keys on each side of the **SCAN** key are user-friendly and convenient for either right-handed or left-handed operator.

Normally, it is used for command execution or input confirmation.

- ▶ When **FN** is pressed, they can be used to alternately turn ON/OFF the backlight of LCD and keypad.

Navigation Keys

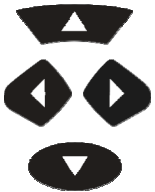

These keys are used to move the cursor left, up, down, or right.

- ▶ While pressing **FN**, they can be used to adjust the luminosity and contrast of the screen backlight.

ESC (Escape)



Normally, this key is used to stop and exit the current operation.

BkSp (Backspace)



If this key is being held down for more than one second, a `clear` code will be sent.

ALPHA (Alpha)



This key is a modifier key that requires pressing a second key to get the yellow-coded letter (A~Z) or symbol printed on the lower side of the second key.

| Icon | Description |
|----------|---|
| A | This icon appears when you press the alpha key once, indicating it is set to alphabetic mode for typing upper-case alphabetic letters. |
| a | This icon appears when you press the alpha key twice, indicating it is set to alphabetic mode for typing lower-case alphabetic letters. |

FN (Function)

This key is a modifier key that requires pressing a second key ([0] ~ [9]) to get the value of key combination.

| Icon | Description |
|---|--|
|  | <p>By default, the function toggle is set to Auto Resume mode, and its behavior is as described below:</p> <ul style="list-style-type: none">▶ This icon appears when you press the function key, indicating it is set to the function mode. Then, press a second key to get the desired function.▶ The icon will go off automatically. |

POWER Key

In order to prevent an accidental press of the POWER key, you need to hold down this key for approximately 1.5 seconds to turn ON/OFF the mobile computer.

Note: (1) Functionality of keys is application-dependent. The system will send the associated key code to the application program, and it is up to the application program to interpret the key code.
(2) When a status icon appears on the screen, it indicates a certain mode is activated and it is not necessary to hold down the modifier key.



1.3.2 44-KEY LAYOUT

The layout of the 44-key keypad includes numeric, alphabetic, navigation and function keys, as well as assorted characters and modifier keys.

Refer to [Appendix III – Key Reference Tables](#) for color-coded keys.



Figure 6: 44-key Layout

The red modifier key  works with a key on which red-coded function or symbol is printed on the upper side. Press the red key, and its associated icon  will be displayed on the screen. Press the second key, say [AB], to complete the key combination and access the function F1. The icon  will go off automatically.

Red-coded function or symbol printed to the upper side



Below briefly describes the functions of common keys on the mobile computer.

SCAN



This yellow key is used to trigger the scan engine so that it can read a barcode when the reader function is enabled.

ENTER



The two keys on each side of the **SCAN** key are user-friendly and convenient for either right-handed or left-handed operator.

Normally, it is used for command execution or input confirmation.

- ▶ When the red modifier key  is pressed, they can be used to alternately turn ON/OFF the backlight of LCD and keypad.

Navigation Keys



These keys are used to move the cursor left, up, down, or right.

- ▶ While pressing the red modifier key , they can be used to adjust the luminosity and contrast of the screen backlight.

ESC (Escape)



Normally, this key is used to stop and exit the current operation.

BkSp (Backspace)



If this key is being held down for more than one second, a `clear` code will be sent.

Space



This key is used to insert a blank space.

Tab



This key is used to insert a tab.

Ins (Insert)



This key is used to turn on/off the insert mode.

Del (Delete)



This key is used to delete the character to the right of the cursor.

Shift Key



The alphabetic keypad is set to upper-case alphabetic mode by default. The [Shift] key serves as a toggle between lower-case and upper-case alphabetic input modes.

It takes turns to show alphabets or symbols when you keep pressing the same key, one to two times (the time interval between each press must not exceed one second).

| Icon | Description |
|------|---|
| | This icon appears when you press [Shift] to set the alphabetic mode to lower-case alphabetic letters. |

Alt Key



This key is a modifier key that modifies the next key pressed. The functionality depends on software application.

| Icon | Description |
|------|--|
| | This icon appears when you press [Alt] to enter the special function mode. |

Red Modifier Key



This key is a modifier key that requires pressing a second key to get the red-coded function (F1~F12, Home, End, PgUp, PgDn) or symbol printed to the upper side of the second key.

In order to get the desired symbol, such as "?", "/" or "\", you must hold down the red modifier key and keep pressing the symbol key, one to two times (the time interval between each press must not exceed one second). The icon will not appear on the screen.

| Icon | Description |
|------|---|
| | <p>By default, the function toggle is set to Auto Resume mode, and its behavior is as described below:</p> <ul style="list-style-type: none"> ▶ This icon appears when you press the red modifier key, indicating it is set to the function mode. Then, press a second key to get the desired function. ▶ The icon will go off automatically. |

POWER Key



In order to prevent an accidental press of the POWER key, you need to hold down this key for approximately 1.5 seconds to turn ON/OFF the mobile computer.

Note: (1) Functionality of keys is application-dependent. The system will send the associated key code to the application program, and it is up to the application program to interpret the key code.

(2) When a status icon appears on the screen, it indicates a certain mode is activated and it is not necessary to hold down the modifier key unless a specific red-coded symbol (?, /, \) is desired.

1.3.3 44-TE KEY LAYOUT

The layout of the 44-TE key keypad includes numeric, alphabetic, navigation and function keys, as well as modifier keys.

Refer to [Appendix III – Key Reference Tables](#) for color-coded keys.







Figure 7: 44-TE key Layout

This alphanumeric keypad is set to numeric mode by default. The [Alpha] key serves as a toggle among numeric, alpha (lower-case alphabetic), and ALPHA (upper-case alphabetic) input modes.

Note: It is not necessary to hold down the [Alpha] key.

The alpha icon will appear on the lower-left corner of the screen in a sequence as shown below.

| Status Icon | Alpha Key | Input Mode |
|-------------|---|-----------------------|
| (none) | N/A | Numbers |
| A | Press  one time | Upper-case alphabetic |
| a | Press  two times | Lower-case alphabetic |

The blue modifier key  works with a key on which blue-coded function or symbol is printed on the upper-right corner. Press the blue key, and its associated icon  will be displayed on the screen. Press the second key, say [F6], to complete the key combination and access the function [F16]. The icon  will go off automatically.

Red-coded alphabetic letter printed above the upper-left corner

Blue-coded function or symbol printed to the upper-right corner

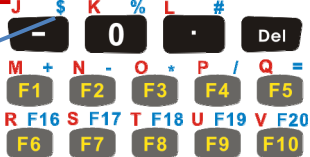

Below briefly describes the functions of common keys on the mobile computer.

SCAN



This yellow key is used to trigger the scan engine so that it can read a barcode when the reader function is enabled.

ENTER



The two keys on each side of the **SCAN** key are user-friendly and convenient for either right-handed or left-handed operator.

Normally, it is used for command execution or input confirmation.

- ▶ When the blue modifier key  is pressed, they can be used to alternately turn ON/OFF the backlight of LCD and keypad.

Navigation Keys



These keys are used to move the cursor left, up, down, or right.

- ▶ While pressing the blue modifier key , they can be used to adjust the luminosity and contrast of the screen backlight.

ESC (Escape)



Normally, this key is used to stop and exit the current operation.

BkSp (Backspace)



If this key is being held down for more than one second, a `clear` code will be sent.

Space



This key is used to insert a blank space.

Tab



This key is used to insert a tab.

Ins (Insert)



This key is used to turn on/off the insert mode.

Del (Delete)



This key is used to delete the character to the right of the cursor.

Alpha Key



This key is a modifier key that requires pressing a second key to get the red-coded letter (A~Z) printed on the upper-left corner of the second key.

| Icon | Description |
|----------|---|
| A | This icon appears when you press the [Alpha] key once, indicating it is set to alphabetic mode for typing upper-case alphabetic letters. |
| a | This icon appears when you press the [Alpha] key twice, indicating it is set to alphabetic mode for typing lower-case alphabetic letters. |

Alt Key



This key is a modifier key that modifies the next key pressed. The functionality depends on software application.

| Icon | Description |
|----------|--|
| <u>A</u> | This icon appears when you press [Alt] to enter the special function mode. |

Blue Modifier Key



This key is a modifier key that requires pressing a second key to get the blue-coded function (F16~F24) or symbol printed on the upper-right corner of the second key.

| Icon | Description |
|----------|---|
| <u>F</u> | <p>By default, the function toggle is set to Auto Resume mode, and its behavior is as described below:</p> <ul style="list-style-type: none"> ▶ This icon appears when you press the red modifier key, indicating it is set to the function mode. Then, press a second key to get the desired function. ▶ The icon will go off automatically. |

POWER Key



In order to prevent an accidental press of the POWER key, you need to hold down this key for approximately 1.5 seconds to turn ON/OFF the mobile computer.

Note: (1) Functionality of keys is application-dependent. The system will send the associated key code to the application program, and it is up to the application program to interpret the key code.
 (2) When a status icon appears on the screen, it indicates a certain mode is activated and it is not necessary to hold down the modifier key.

1.4 LCD

The mobile computer comes with a 3" FSTN graphic LCD, 160 by 160 pixels resolutions, which can be programmed to display text or graphics, such as specific font and company logo, to meet varying application needs.



















| Options | Font Size (pixels) | Characters by lines |
|---------------------------------------|--------------------------|---------------------------|
| English font | Font size 6×8 (pixels) | 26 characters by 19 lines |
| | Font size 8×16 (pixels) | 20 characters by 9 lines |
| Chinese font | Font size 16×16 (pixels) | 10 characters by 9 lines |
| Other language fonts, company logo... | Programmable | |

Note: The bottom line (ICON_ZONE) is reserved to display status icons, such as the battery icon.

1.4.1 ADJUSTING THE BACKLIGHT

The backlight of screen and keypad helps ease reading under dim environments. It can be turned on and adjusted decreasingly or increasingly by the following key combinations. Keep pressing the key combination until the luminosity or contrast is decreased or increased to a desired level.

Note: Using backlight while on battery power will substantially reduce battery power. We suggest that you dim the backlight while working in a well-lit area or have it set to be automatically turned off when not in use.

| Key Combination | | | Action |
|---|---|---|--|
| 24-key | 44-key | 44-TE key | |
|  + [Enter] |  + [Enter] |  + [Enter] | Toggle ON/OFF the backlight |
|  + [Up] |  + [Up] |  + [Up] | Turn ON the backlight and increase the contrast of LCD |
|  + [Down] |  + [Down] |  + [Down] | Turn ON the backlight and decrease the contrast of LCD |
|  + [Right] |  + [Right] |  + [Right] | Turn ON the backlight and increase the luminosity of LCD |
|  + [Left] |  + [Left] |  + [Left] | Turn ON the backlight and decrease the luminosity of LCD |
| | |  + [3] | Same as  + [Up] |
| | |  + [6] | Same as  + [Down] |

Note: Hold down the first key, and press the second key for adjustment.

1.4.2 CALIBRATING THE SCREEN

This LCD is also a touch screen, which enables the use of a stylus for handwriting. It also features signature capture that can save signature as confirmation of receipt when delivering goods to door.

Refer to [3.2.8 Screen Calibration](#) for screen & contrast calibration.

Warning: DO NOT use any pointed or sharp objects to move against the surface of the screen.

1.5 NOTIFICATIONS

1.5.1 STATUS LED

The dual-color LED above the [SCAN] trigger is used to provide information on the charging status and can be programmed to provide information that helps diagnosing. For example, if you are using AG Runtime, you will be informed of the scanning result immediately. The green LED is used for "Good Read" upon reading a barcode successfully.

| LED: Red/Green | Red | Green |
|----------------|-----|-------|
| Charging 8500 | On | --- |
| Charging done | --- | On |
| Good Read | --- | On |
| Error occurs | On | --- |

1.5.2 AUDIO

The mobile computer has a low power transducer type buzzer, which can be programmed for status feedback. In particular, its frequency and duration are software programmable for Good Read in the provided terminal emulation programs.

1.5.3 VIBRATOR

The mobile computer is integrated with a vibrator, which can be programmed for status feedback. It can be helpful when working in noisy environments. In particular, the vibrator is software programmable for Good Read in the provided terminal emulation programs.

1.6 DATA CAPTURE

Options of different reader combination are allowed, such as 1D+RFID and 2D+RFID. For each combination, both readers can be initialized and ready for scanning at the same time (dual mode operation). For example, if you press the [SCAN] trigger while running the preloaded AG runtime on the mobile computer, it will read a barcode in position or an RFID tag in proximity depending on which one comes first.

Note: You cannot have 1D+2D scan engines installed on the mobile computer because they are both barcode readers!

Varying by the reader type installed, the supported symbologies or tag types are listed below.

- ▶ 1D CCD scan engine
- ▶ 1D Laser scan engine
- ▶ 1D Long Range Laser scan engine (LR)
- ▶ 1D Extra Long Range Laser scan engine (ELR)
- ▶ 2D scan engine
- ▶ RFID reader

1.6.1 SYMBOLOGIES SUPPORTED

A wide variety of scan engines is available for delivering flexibility to meet different requirements. Depending on the scan engine integrated, the mobile computer is capable of scanning barcodes of a number of symbologies that are enabled by default while running the preloaded AG runtime. Refer to [3.3.1 Reader](#) for functional test.

If you need to scan barcodes that are encoded in a symbology, which is disabled by default in AG runtime, **FORGE Application Generator** (ForgeAG.exe) allows configuring symbology settings, as well as reader settings. First, enable the desired symbologies, and then, download the application settings to the mobile computer.

Note: In AG or CipherNet runtime, not all of the symbologies are enabled by default. Instead of running any of them, you can develop your own applications to control the scan engine for data collection. For details on configuring reader and symbology settings, please refer to the documentation of the software you use.

| Symbologies Supported (Default Setting: Enable/Disable) | | CCD/Laser | LR/ELR | 2D |
|---|---------------------|-----------|---------|----------|
| Codabar | | Enabled | Enabled | Enabled |
| Code 11 | | | | Enabled |
| Code 93 | | Enabled | Enabled | Enabled |
| Composite Code | CC-A/B | | | Disabled |
| | CC-C | | | Disabled |
| | TCIF Linked Code 39 | | | Enabled |

| | | | | |
|--------------------------|--------------------------------------|----------|----------|----------|
| MSI | | Disabled | Enabled | Enabled |
| Plessey | | Disabled | | |
| Postal Codes | | | | Enabled |
| Telepen | | Disabled | | |
| Code 128 | Code 128 | Enabled | Enabled | Enabled |
| | GS1-128 (EAN-128) | Enabled | Enabled | Enabled |
| | ISBT 128 | Enabled | Enabled | Enabled |
| Code 2 of 5 | Industrial 25 (Discrete 25) | Enabled | Enabled | Enabled |
| | Interleaved 25 | Enabled | Enabled | Enabled |
| | Matrix 25 | Disabled | | |
| Code 3 of 9 | Code 39 | Enabled | Enabled | Enabled |
| | Trioptic Code 39 | | Disabled | Disabled |
| | Italian Pharmacode (Code 32) | Disabled | Disabled | Disabled |
| | French Pharmacode | Disabled | | |
| EAN/UPC | EAN-8 | Enabled | Enabled | Enabled |
| | EAN-8 Addon 2 | Disabled | Disabled | Disabled |
| | EAN-8 Addon 5 | Disabled | Disabled | Disabled |
| | EAN-13 | Enabled | Enabled | Enabled |
| | EAN-13 & UPC-A Addon 2 | Disabled | Disabled | Disabled |
| | EAN-13 & UPC-A Addon 5 | Disabled | Disabled | Disabled |
| | Bookland EAN (ISBN) | Disabled | Disabled | Disabled |
| | UPC-E0 | Enabled | Enabled | Enabled |
| | UPC-E1 | Disabled | Disabled | Disabled |
| | UPC-E Addon 2 | Disabled | Disabled | Disabled |
| | UPC-E Addon 5 | Disabled | Disabled | Disabled |
| | UPC-A | Enabled | Enabled | Enabled |
| GS1 DataBar (RSS) | GS1 DataBar Omnidirectional (RSS-14) | Disabled | Enabled | Enabled |
| | GS1 DataBar Truncated | Disabled | Enabled | Enabled |
| | GS1 DataBar Stacked | Disabled | Enabled | Enabled |
| | GS1 DataBar Stacked Omnidirectional | Disabled | Enabled | Enabled |
| | GS1 DataBar Limited (RSS Limited) | Disabled | Enabled | Enabled |
| | GS1 DataBar Expanded (RSS Expanded) | Disabled | Enabled | Enabled |
| | GS1 DataBar Expanded Stacked | Disabled | Enabled | Enabled |
| 2D Symbologies | PDF417 | | | Enabled |
| | MicroPDF417 | | | Enabled |

| | | | | |
|--|-------------|--|--|---------|
| | Data Matrix | | | Enabled |
| | Maxicode | | | Enabled |
| | QR Code | | | Enabled |

1.6.2 RFID TAGS SUPPORTED

The RFID reader supports read/write operations depending on the tags. The supported labels include ISO 15693, Icode®, ISO 14443A, and ISO 14443B. Currently, the performance of some tags has been confirmed, and the results are listed below for your reference. Refer to [3.3.9 RFID](#) for functional test.

Note: You should study the specifications of RFID tags before use.

| RFID Module Version 1.0 | | UID Only | Read Page | Write Page |
|------------------------------|--------------------|----------|-----------|------------|
| ISO 14443A | Mifare Standard 1K | ✓ | ✓ | ✓ |
| | Mifare Standard 4K | ✓ | ✓ | ✓ |
| | Mifare Ultralight | ✓ | ✓ | ✓ |
| | Mifare DESFire | ✓ | --- | --- |
| | Mifare S50 | ✓ | ✓ | ✓ |
| | SLE44R35 | ✓ | --- | --- |
| | SLE66R35 | ✓ | ✓ | ✓ |
| ISO 14443B | SRIX 4K | ✓ | ✓ | ✓ |
| | SR176 | ✓ | ✓ | ✓ |
| ISO 15693 | ICODE SLI | ✓ | ✓ | ✓ |
| | SRF55V02P | ✓ | --- | --- |
| | SRF55V02S | ✓ | --- | --- |
| | SRF55V10P | ✓ | --- | --- |
| | TI Tag-it HF-I | ✓ | ✓ | ✓ |
| ICODE® (Phillips) | ICODE | ✓ | ✓ | ✓ |

1.7 CHARGING & COMMUNICATIONS

You can use a cradle or charger to charge the mobile computer and/or its battery.

1.7.1 CRADLE OPTIONS

A variety of cradles are available to meet different requirements. The cradle is designed for charging and communications at the same time. You may choose a cradle type that best suits your needs.

| Task | Cradle Interface |
|----------------|--|
| Charging | 6 V charging from the adaptor |
| Communications | Depends on the cradle type and its associated settings — <ul style="list-style-type: none"> ▶ RS-232 ▶ Modem ▶ Ethernet |

Note: Battery charging stops when the temperature drops below 0°C or exceeds 40°C. It is recommended to charge the battery at room temperature (18°C to 25°C) for optimal performance.

- 1) Seat the mobile computer in the cradle.
- 2) Connect the power supply cord to the power receptacle on the back of the cradle.
- 3) Connect the other end of the power cord to a suitable power outlet.
- 4) Connect the RS-232 cable if data transmission is required.

Refer to the separate manual for configuring your cradle.

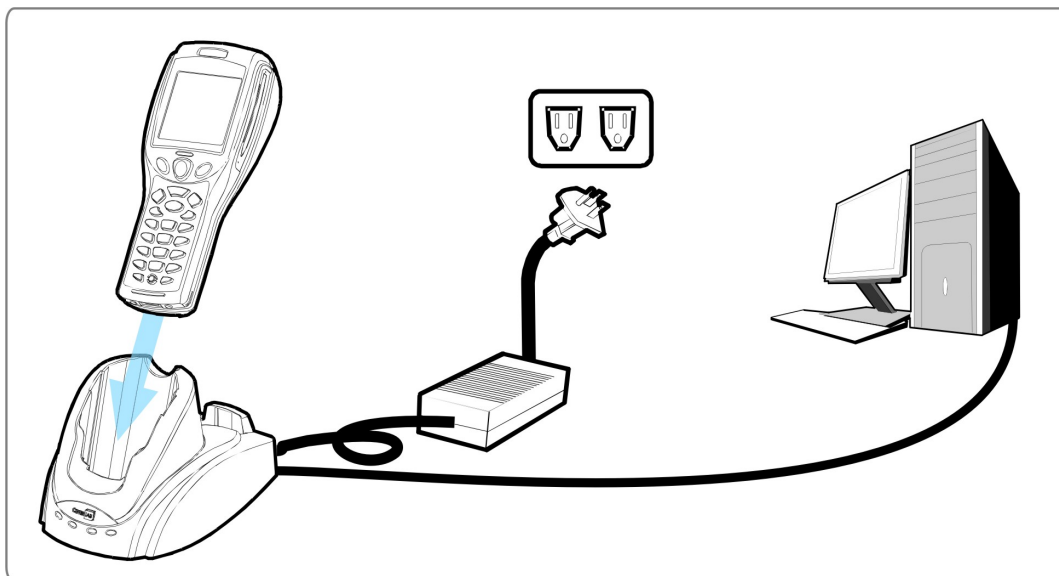
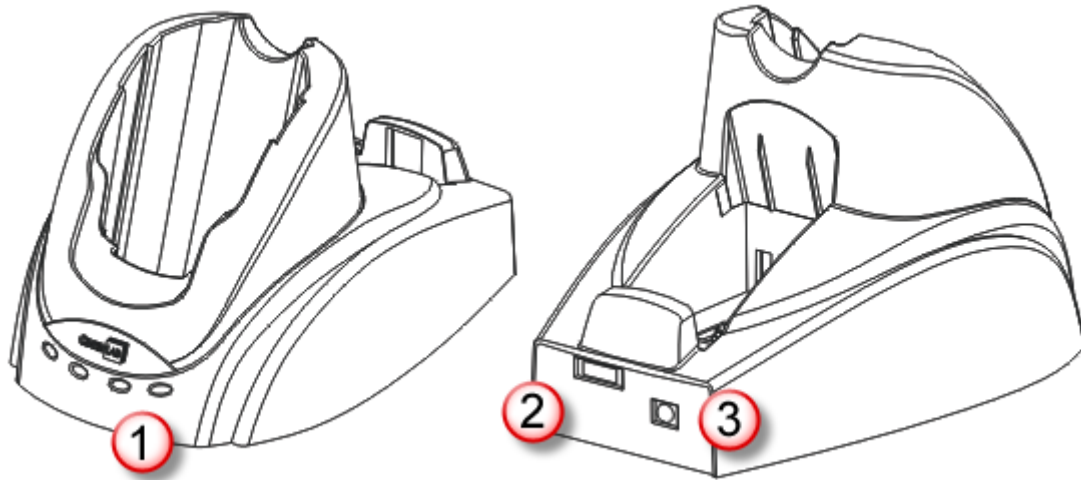

Figure 8: Setting up cradle

Charging & Communication Cradle



| No. | Description | No. | Description |
|-----|--|-----|--------------------------|
| 1 | LED Indicators (from left to right): <ul style="list-style-type: none">▶ Charging▶ Receive Data▶ Transmit Data▶ Power Refer to 1.7.2 Understanding the LED Indicators . | 2 | Cable Connector (RS-232) |
| 3 | Power Jack | | |

Modem Cradle

Delivering flexibility in making a connection, the Modem Cradle integrates the modem functionality (56 kbps) into the cradle. You may choose to use the modem or RS-232 port by sliding the DIP switch.

Modem Connection

- ▶ To use the modem functionality, slide the DIP switch to right:  Modem
- ▶ When the power cable is properly connected, the LED light of POWER on the front panel will be solid red.

RS-232 Connection

- ▶ To use the RS-232 port, slide the DIP switch to left:  RS-232
- ▶ When the power cable is properly connected, the LED light of POWER on the front panel will be solid green.

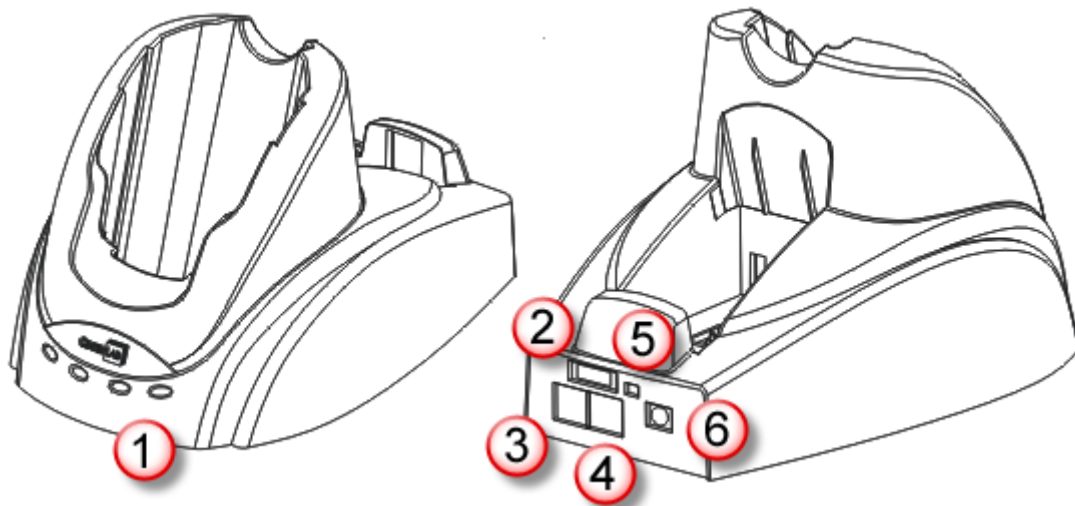

| No. | Description | No. | Description |
|-----|---|-----|--------------------------|
| 1 | LED Indicators (from left to right): <ul style="list-style-type: none"> ▶ Charging ▶ Receive Data ▶ Transmit Data ▶ Power Refer to 1.7.2 Understanding the LED Indicators . | 2 | Cable Connector (RS-232) |
| 3 | Phone Jack | 4 | Line Jack |
| 5 | DIP Switch (RS-232/Modem) | 6 | Power Jack |

Ethernet Cradle

Refer to the Ethernet Cradle manual for more information.

Auto-detect Connection

Slide the DIP switch to left:  Auto

- ▶ The RS-232 connection will override Ethernet connection when both are present. However, you can use cradle commands to switch in between the two.
- ▶ When the power cable is properly connected, the LED light of POWER on the front panel will be solid green.

LAN Connection

Slide the DIP switch to right:  LAN

- ▶ Only the Ethernet connection can be established. However, you can use cradle commands to switch in between the two.
- ▶ When the power cable is properly connected, the LED light of POWER on the front panel will be solid red.

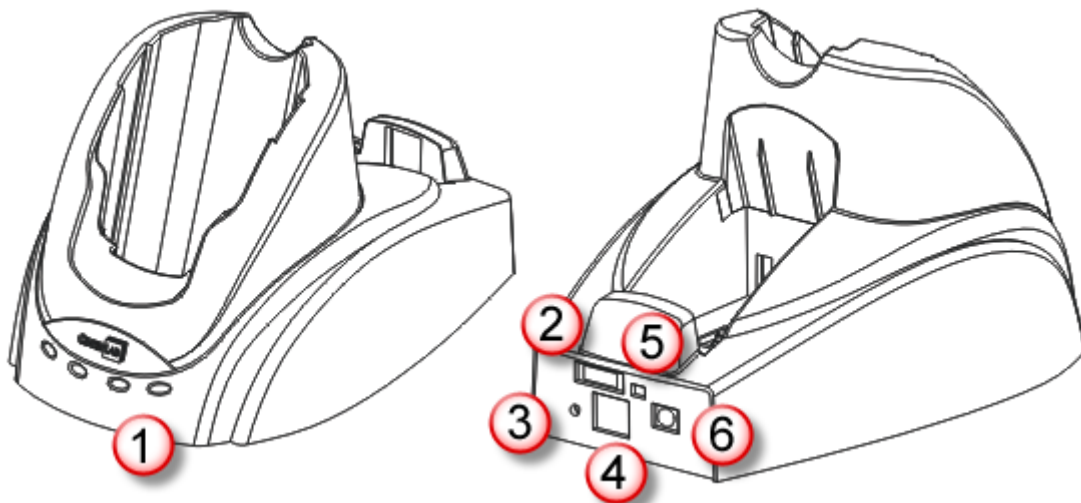

| No. | Description | No. | Description |
|-----|--|-----|--------------------------|
| 1 | LED Indicators(from left to right): <ul style="list-style-type: none"> ▶ Charging ▶ Receive Data ▶ Transmit Data ▶ Power Refer to 1.7.2 Understanding the LED Indicators . | 2 | Cable Connector (RS-232) |
| 3 | IP Reset Switch | 4 | Ethernet Port (RJ-45) |
| 5 | DIP Switch (Auto/LAN) | 6 | Power Jack |

1.7.2 UNDERSTANDING THE LED INDICATORS

For charging status of the loaded battery in the mobile computer, view the device screen.

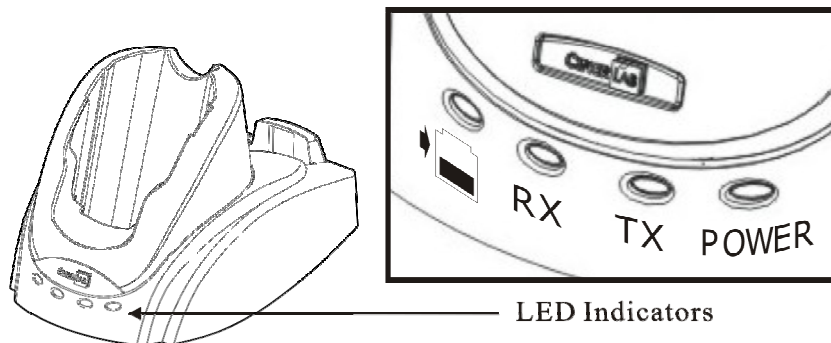



Figure 9: Cradle LEDs

| Indicator | Status | Description |
|--|---------------------|---------------------------------------|
|  (Spare battery charging) | Off | Battery not ready |
| | Red, solid | Charging |
| | Green, solid | Charging done |
| | Red/green, flashing | Error occurs |
| RX (Receive data) | Off | No activity |
| | Red, solid | Receiving data from Ethernet or host |
| TX (Transmit data) | Off | No activity |
| | Red, solid | Transmitting data to Ethernet or host |
| POWER | Off | Power off |
| | Green, solid | Direct connection via RS-232 |
| | Red, solid | Modem/Ethernet connection |

Warning: Charging error may occur due to a power failure or defected battery contacts.

1.7.3 4-SLOT BATTERY CHARGER

Below is the 4-Slot Battery Charger.

- 1) The Battery Charger can be mounted on table or wall. Drill two holes (centers spaced 160 millimeters apart), secure the two supplied screws, and mount the Battery Charger by sliding over screws.
- 2) Slide the battery pack into the compartment at a proper angle (30°~45°) so that the metal contacts on the battery are met with the charging contacts inside the compartment.
- 3) Connect the power supply cord to the power receptacle on the charger. Connect the other end of the power supply cord to a suitable power outlet.
- 4) Press the power switch on, and the Battery Charger's LED will be red.
- 5) While charging, the LED of the battery compartment will be red. When fully charged, the LED will be green.

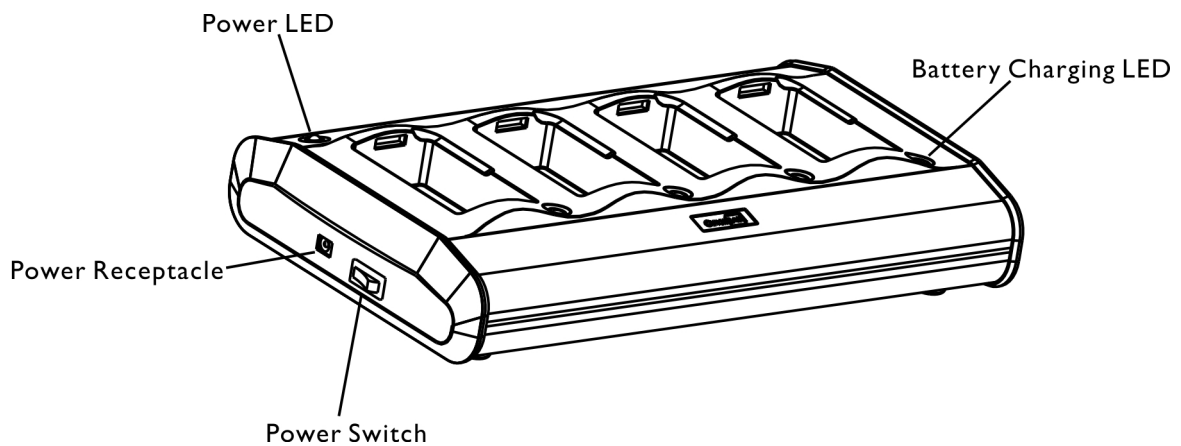

Figure 10: 4-Slot Battery Charger

| Indicator | Status | Description |
|-------------------------|---------------------|-------------------|
| Power | Off | Power off |
| | Red, solid | Power on |
| Battery Charging | Off | Battery not ready |
| | Red, solid | Charging |
| | Green, solid | Charging done |
| | Red/green, flashing | Error occurs |

LEARNING SOFTWARE ARCHITECTURE

This chapter mainly describes the software inside the mobile computer. It consists of three modules — Kernel, System, and Application; each has a function menu.

When a menu is displayed, you may select an item by either of the following ways:





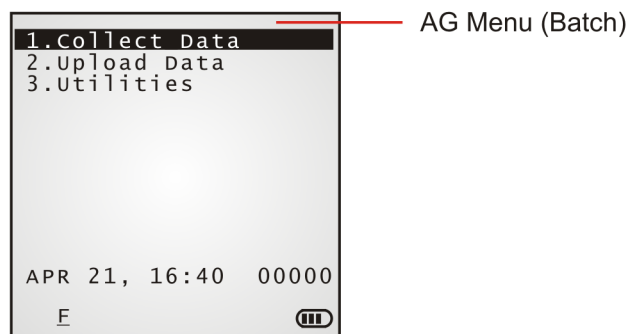
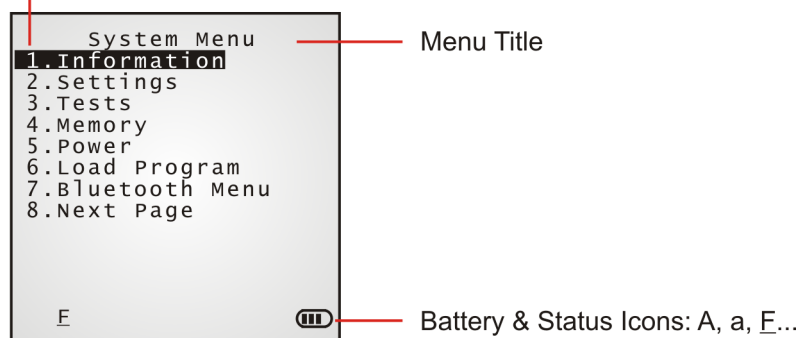

- ▶ Press the arrow keys [Up] and [Down] to move the highlight bar.
- ▶ Press the number key that corresponds to the item number.
- ▶ Use the stylus to tap that item or the item number
- ▶ Follow the on-screen instructions to change a specific setting, or press [ESC] to return to a previous page or menu.

Item No. (Shortcut keys)



On each screen, the bottom line displays status icons, such as:

- ▶ The 4-bar battery icon indicates the current power status.
- ▶ The status icon of input or function mode is controlled by the modifier key.

| Icon | Description |
|--------------|--|
| A / a | <ul style="list-style-type: none"> ▶ For 24-key keypad operation, input mode controlled by [ALPHA] key . ▶ For 44-TE key keypad operation, input mode controlled by [Alpha] key . |
| ↑ | <ul style="list-style-type: none"> ▶ For 44-key keypad operation, input mode controlled by [Shift] key . |
| F | <ul style="list-style-type: none"> ▶ For 24-key keypad operation, function mode controlled by [FN] key . ▶ For 44-key keypad operation, function mode controlled by red key . ▶ For 44-TE key keypad operation, function mode controlled by blue key . |

- ▶ The turn-page icon () indicates there is a previous page or menu.

To return to a previous page or menu, you may press [ESC], touch the menu title, or follow the on-screen instructions.

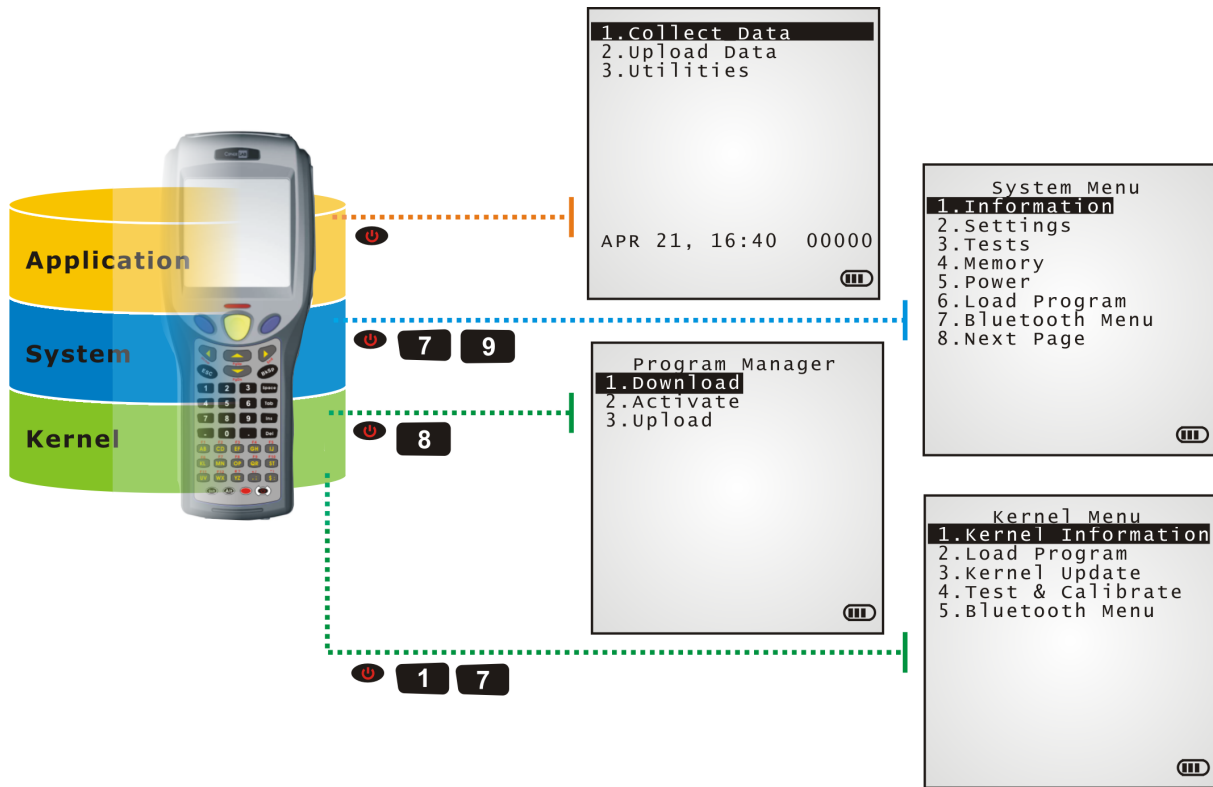

Figure 11: Software Architecture

IN THIS CHAPTER

| | |
|--------------------------------|----|
| 2.1 Application Module | 37 |
| 2.2 System Configuration | 39 |

2.1 APPLICATION MODULE

The mobile computer ships with software package on the CD-ROM. It includes **FORGE Application Generator** (batch and WLAN versions), **MIRROR Emulator** (VT and 5250 versions), download utilities, etc.

2.1.1 FORGE APPLICATION GENERATOR (AG)

For easy development of applications, the mobile computer is preloaded with AG runtime. When you turn on the mobile computer, it displays the Main Menu of AG application, as shown below.

Batch AG

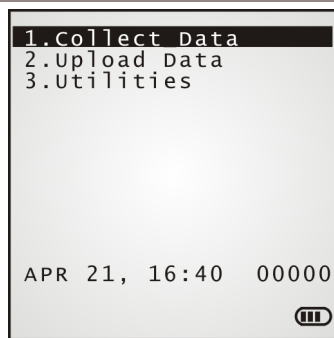

WLAN AG

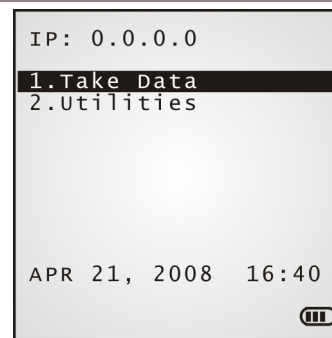

Note: Batch AG supports automatically uploading data to a host computer when the upload interface is properly configured. Once the mobile computer is seated in the cradle, there will be a moving hourglass icon displayed on the upper-right corner of the screen, indicating the mobile computer is ready for auto upload.

Before using the mobile computer to collect data, you need to configure the application with the companion tool on your computer. This time-saving development tool helps create application templates on your computer.

For details on the AG application, please refer to separate user manual.

| Application Generator | AG Runtime | Companion Tool on PC End |
|-----------------------|------------|--------------------------|
| Batch AG | U8500.SHX | ForgeAG.exe |
| WLAN AG | WU8500.SHX | AG8500WLAN.exe |

Note: FORGE Application Generator (AG) software package includes
 (1) a companion tool for quickly developing your application — Batch or WLAN AG;
 (2) several download utilities to make it versatile in use.

2.1.2 MIRROR EMULATOR (CIPHERNET)

The mobile computer supports VT100/220 and IBM 5250 terminal emulation for accessing a backend database. Instead of using **FORGE Application Generator**, you may download the terminal emulation program, i.e. CipherNet Runtime, to the mobile computer. Refer to [3.6 Load Program](#). Then, run individual companion tool on your computer.

For details on the **MIRROR Emulator** application, please refer to separate user manuals.

| Terminal Emulation | CipherNet Runtime | Companion Tool on PC End |
|--------------------|-------------------|--------------------------|
| VT100/220 | 85xx-VT.SHX | CipherNet-VT.exe |
| IBM 5250 | 85xx-5250.SHX | CipherNet-5250.exe |

2.1.3 USER PROGRAM

You may need to develop your own application program. For developing custom applications, CipherLab provides BASIC and C compilers through licensing. For detailed information, please contact your sales representative.

2.2 SYSTEM CONFIGURATION & CORE

For managing system configurations and multiple programs, each mobile computer comes with the **System Menu**, **Program Manager**, and **Kernel**. Refer to the following chapters on how to configure the 8500 Series Mobile Computer, regarding system configurations and program download.

2.2.1 SYSTEM MENU

[System Menu](#) is bundled with BASIC Runtime or user programs that are written in "C". It is provided for system configuration, functionality testing, downloading font file and program.

2.2.2 KERNEL

[Kernel](#) is the innermost core of the OS. It provides services for downloading the active application program or font file, updating the kernel and configuring Bluetooth settings.

2.2.3 PROGRAM MANAGER

[Program Manager](#) is part of the kernel. You may download as many as seven application programs, or six programs plus one font file.

SYSTEM MENU

System Menu is generated by a powerful utility, which offers an interface for engineers (programmers or system integrator) to view system information, change the configuration parameters, download programs and run diagnostics.

This menu is designed for engineering tests and maintenance ONLY. For this reason, it provides password protection to prevent unauthorized users from accidentally changing system settings.

Warning! System Menu is NOT for the use of any end users. The system password helps ensure system safety and integrity.

How to access the System Menu?

- 1) Turn off the mobile computer.
- 2) Press [7] + [9] + [Power].



IN THIS CHAPTER

| | |
|---------------------------|----|
| 3.1 Information..... | 42 |
| 3.2 Settings | 44 |
| 3.3 Tests | 47 |
| 3.4 Memory..... | 49 |
| 3.5 Power | 50 |
| 3.6 Load Program..... | 51 |
| 3.7 Bluetooth Menu | 53 |
| 3.8 Serial PPP Menu..... | 63 |
| 3.9 IR Network Menu | 66 |
| 3.10 Wi-Fi Menu..... | 69 |

3.1 INFORMATION

Here provides important system information to help diagnose the system.

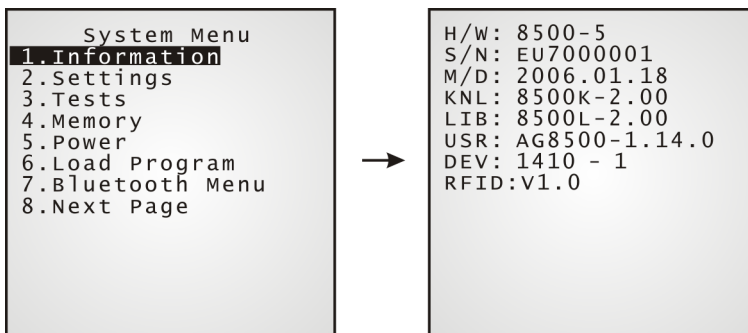

System Menu | 1. Information

| | |
|-------------|---|
| H/W | Hardware version |
| S/N | A serial number assigned to the mobile computer |
| M/D | Manufacturing date |
| KNL | Kernel version |
| LIB | C library version |
| BSC | BASIC Run-time version, if a BASIC application is downloaded |
| USR | Application program version |
| DEV | 5-digit code for optional hardware configurations <ul style="list-style-type: none"> ▶ For example, 1410-1 indicates the 44-key mobile computer is equipped with CCD scan engine, RFID reader, Bluetooth module, and 802.11b/g connectivity. |
| RFID | RFID module version if present; the 3 rd digit of the above Device Code must be 1 |

3.1.1 UNDERSTANDING DEVICE CODE

| Device Code | Modular Component | Types |
|-------------|-------------------|--|
| 1st digit | Reader module | 0= none 1= CCD scan engine 2= Laser scan engine 3= 2D scan engine 4= Long Range Laser scan engine 5= Extra Long Range Laser scan engine |
| 2nd digit | Wireless module | 4= Bluetooth + 802.11b/g (8570) 5= Bluetooth only (8500) |
| 3rd digit | RFID module | 0= none 1= RFID reader |
| 4th digit | Reserved | 0 |
| 5th digit | Keypad layout | 0= 24-key 1= 44-key 2= 44-TE key |

3.2 SETTINGS

You can change the default settings here.

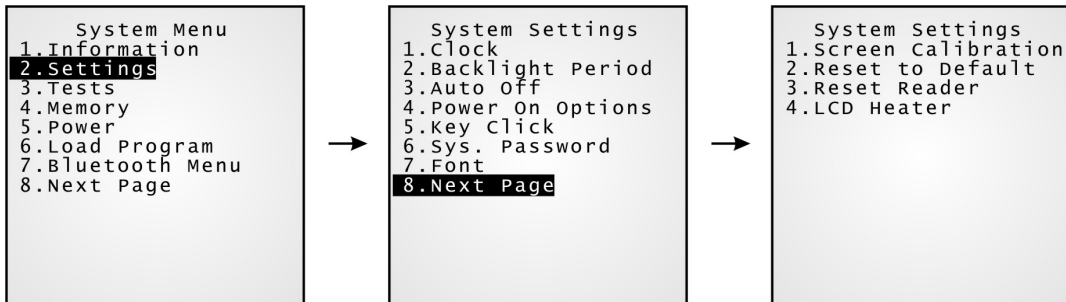

| System Settings | Default Values |
|-------------------------|---|
| Clock | Current time |
| Backlight Period | 20 seconds, Level 2 |
| Auto Off | 10 minutes |
| Power On Options | Program Resume |
| Key Click | Tone 2 |
| System Password | Open access |
| Font | System font |
| Reset to Default | Load factory settings |
| Reset Reader | Restore default reader settings of 2D or (Extra) Long Range Laser scan engine |
| LCD Heater | Disabled |

3.2.1 CLOCK

Set date and time for Real Time Clock. Enter two digits for the year, e.g. 04 for 2004.

3.2.2 BACKLIGHT PERIOD

Set the backlight duration for the keypad and LCD.

- ▶ Enter a value between 0 and 9999 (second).
- ▶ Press the arrow keys [Up] and [Down] to adjust the backlight level (4 levels).

3.2.3 AUTO OFF

The mobile computer will be turned off automatically when no operation is taking place during a specified period of time. Enter a value between 0 and 999 (minute).

Note: To disable this function, enter 0.

3.2.4 POWER ON OPTIONS

Set the startup screen once the mobile computer is turned on. Press the arrow keys [Up] and [Down] to select “[0] Program Resume” or “[1] Program Restart”, and then press [ENTER].

- ▶ Program Resume: When selected, the mobile computer will start from the last session of program before it is turned off.
- ▶ Program Restart: When selected, the mobile computer will start from the first session of the program.

3.2.5 KEY CLICK

The system will produce an audible signal when any key on the keypad is pressed. The current value is highlighted. Select a desired tone for the buzzer or mute it.

3.2.6 SYSTEM PASSWORD

Set a password to control user access to the **System Menu**, **Program Manager** and **Kernel Menu**. The password can be up to eight alphanumeric characters.

Note: The password is case-sensitive. To disable a previous password, enter blank on the "Input new password" and "Verify password" screens.

3.2.7 FONT

Font version information can be viewed here. It displays System Font if there is no custom font file. If a multi-language font file is downloaded, you will be able to select a font from the list.

3.2.8 SCREEN CALIBRATION

The cross mark will appear on the four corners of the screen for alignment. Use the tip of the stylus to tap at the center of the cross mark firmly and accurately.

To start with contrast calibration, press [1]+[9] simultaneously. Refer to [1.4.1 Adjusting the Backlight](#) for screen & backlight settings.

Warning: DO NOT use any pointed or sharp object to move against the screen.

3.2.9 RESET TO DEFAULT

Reset system settings to the default values, except for the reader settings.

3.2.10 RESET READER

Reset reader settings to the default values when one of the following scan engines is installed for use:

- ▶ 2D scan engine
- ▶ Long Range Laser scan engine
- ▶ Extra Long Range Laser scan engine

3.2.11 LCD HEATER

Set the heater functionality. When enabled, it will start to heat when the environmental temperature falls below -10 Celsius degrees.

3.3 TESTS

Here provides functional tests for key parts.

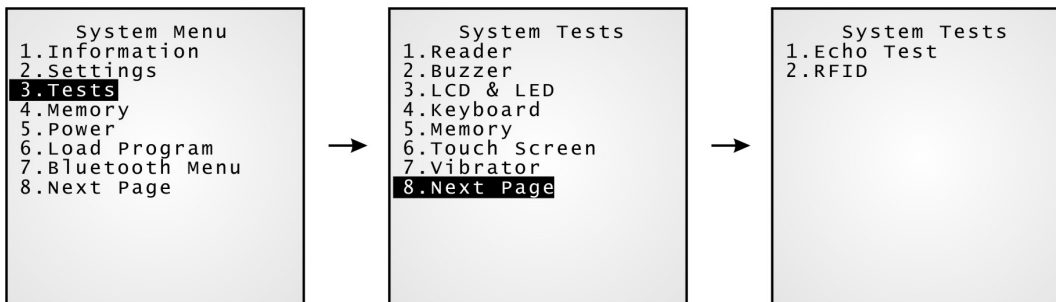

3.3.1 READER

Test the reading performance of the scanner. The supported symbologies depend on the scan engine you use. Refer to [1.6 Data Capture](#) for symbologies that are enabled by default. For symbologies that are disabled by default, they must be enabled through programming.

- ▶ Press [SCAN] to start. To stop and exit the test, press any key.

3.3.2 BUZZER

Test the buzzer with different frequency/duration combinations.

- ▶ To stop and exit the test, press any key.

3.3.3 LCD & LED

Test the LCD display and LED indicator.

- ▶ To stop and exit the test, press any key.

3.3.4 KEYBOARD

Test the rubber keys. Press any key and its corresponding character will be shown on the screen.

- ▶ To stop and exit the test, press [ESC].

3.3.5 MEMORY

Test the data memory (SRAM), and the results will be shown on the screen.

- ▶ To stop and exit the test, press [ESC].

Warning! The contents of the data memory (SRAM) will be wiped out after test.

3.3.6 TOUCH SCREEN

Test signature capture by using the stylus for handwriting.

- ▶ To stop and exit the test, press [ESC] or tap [OK] on the screen.

3.3.7 VIBRATOR

Test the vibrator.

- ▶ To stop and exit the test, press [ESC].

3.3.8 ECHO TEST

After a physical connection is established properly, run the test utility on your computer and start this test on your mobile computer. Select a desired baud rate if necessary.

- ▶ To stop and exit the test, press [ESC].

| Interface | Description | Test Utility |
|----------------|--|--------------|
| IR (Cradle-IR) | This echo test is to verify connectivity via IR between the mobile computer and any cradle. | EchoTest.exe |
| Modem | This echo test is to verify connectivity via the Modem Cradle. A telephone line must be connected to the Modem Cradle. | EchoTest.exe |

Note: For the Modem Cradle, any value other than 57600 bps (default) must be configured through the DIP switch on the IR control board.

3.3.9 RFID

Test the reading performance of the RFID reader when a proximity card is present. Refer to [1.6.2 RFID Tags Supported](#) for the supported RFID tags.

- ▶ To stop and exit the test, press [ESC].

3.4 MEMORY

Here provides information and initialization function of the memory.

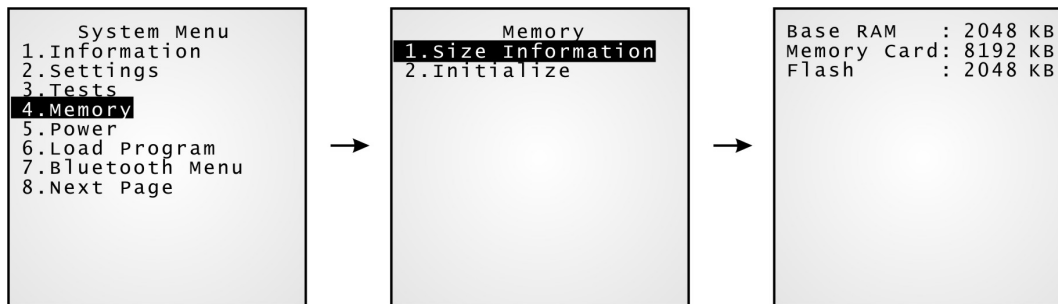

3.4.1 SIZE INFORMATION

- ▶ Base RAM — onboard SRAM for data memory
- ▶ Memory Card — optional data memory
- ▶ Flash — program memory

3.4.2 INITIALIZE

Initialize the data memory, Base RAM or Memory Card.

Warning! The contents of the data memory (SRAM) will be wiped out after memory initialization.

3.5 POWER

Here shows current voltage consumption.

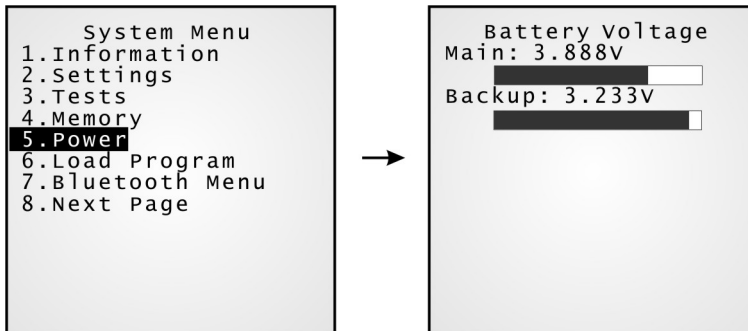

Main (battery)

It shows dynamic status of the battery pack, which is used as the main power source.

Backup (battery)

It shows dynamic status of the button cell, which is used to retain data in SRAM.

Warning! Always examine the battery icon on the device screen so that you will be alerted for a low battery condition.

3.6 LOAD PROGRAM

Here you can access the [Load Program](#) service provided by the kernel. Because the kernel will take over the job, you will not be able to return to **System Menu** by pressing [ESC]. After downloading, restart the mobile computer to activate the new program. Refer to [Appendix I Download Utility](#).

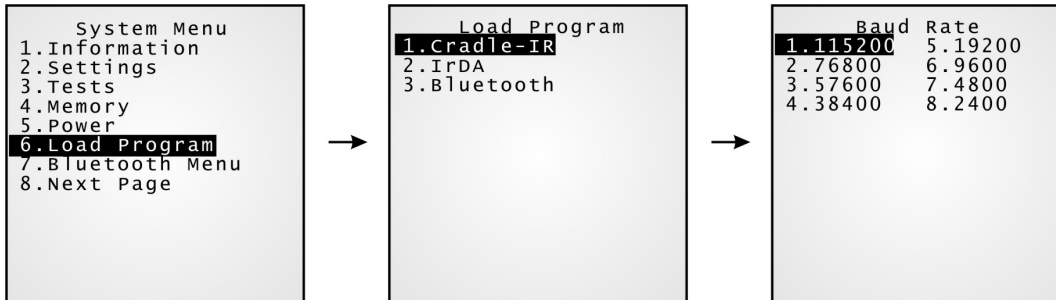

Note: The mobile computer will stay in download mode for approximately 30 seconds.

.SHX Program

Download one of the following C program files and/or font file:

Program File

- ▶ AG Runtime: U8500.shx (Batch AG)
WU8500.shx (WLAN AG)
- ▶ CipherNet Runtime: 85xx-5250.shx (CipherNet-5250)
85xx-VT.shx (CipherNet-VT)
- ▶ BASIC Runtime^{Note}: B8500.shx
- ▶ User program

Font File

Refer to the Font Files folder on CD-ROM.

If you have downloaded a BASIC Runtime program, the next time you enter the Load Program submenu you will be able to select whether to download a C program (.SHX) or BASIC program (.SYN).

Note: "Load Basic" menu is only available after you have downloaded a BASIC Runtime program.

SETTINGS
Interface

| Options | Description |
|-----------|---|
| Cradle-IR | Proceed to configure baud rate settings on your computer and the mobile computer. |
| IrDA | Point to the target IrDA device. |
| Bluetooth | Approach the target Bluetooth enabled device. |

Baud Rate

| Options | Supported by CipherLab software, including download utilities | |
|--------------|---|----|
| 115200 (bps) | Yes | |
| 76800 (bps) | | No |
| 57600 (bps) | Yes | |
| 38400 (bps) | Yes | |
| 19200 (bps) | Yes | |
| 9600 (bps) | Yes | |
| 4800 (bps) | | No |
| 2400 (bps) | | No |

LOAD PROGRAM VIA BLUETOOTH

- 1) Go to **System Menu | 7. Bluetooth Menu | 3. Security**, and configure the following Bluetooth settings first.
 - ▶ Authentication
 - ▶ PIN code
- 2) Go to **System Menu | 6. Load Program** and select Bluetooth.
- 3) Start the pairing procedure from your computer, for example, click [Pair Device] and/or [Connect Bluetooth Serial Port].
- 4) Run the download utility: ProgLoad.exe
 - Select interface RS-232/IrDA for using Bluetooth SPP.
 - Select COM port properties that match with the serial port settings used on your computer.

3.7 BLUETOOTH MENU

This submenu is for the mobile computer, with built-in Bluetooth module, to work with other Bluetooth enabled devices. You must configure these parameters correctly.

Note: Due to the fact that the production of 3560 (Bluetooth Access Point) has been discontinued, CipherLab will cease to maintain the Bluetooth PAN (=BNEP) functionality on the mobile computer since the year of 2011.

| Bluetooth Settings | Default Value | HID | SPP | DUN | PAN |
|------------------------|------------------------|---------------------------------|-----|---------------------|-----|
| Connect Setting | | Items Need to Be Checked | | | |
| Local Name | Model no. + Serial no. | v | v | v | v |
| Remote Name | --- | --- | v | v | v |
| Broadcast Me | Enabled | v | v | v | v |
| Power Saving | Enabled | v | v | v | v |
| BT-GPRS AP Name | --- | --- | --- | (v) ^{Note} | --- |
| Security | | | | | |
| Authentication | Disabled | v | v | v | v |
| PIN Code | --- | v | v | v | v |
| Network Setting | | | | | |
| DHCP | Enabled | --- | --- | (v) ^{Note} | --- |
| SubNet Mask | 255.255.128.0 | --- | --- | --- | v |
| Local IP Address | 0.0.0.0 | --- | --- | (v) ^{Note} | --- |
| Default Gateway | 0.0.0.0 | --- | --- | --- | v |
| DNS Server | 0.0.0.0 | --- | --- | --- | v |
| Domain Name | --- | --- | --- | --- | v |

Note: BT-GPRS AP name, DHCP and local IP Address are required for DUN-GPRS mode only.

3.7.1 INFORMATION

Information of network configuration can be viewed here.

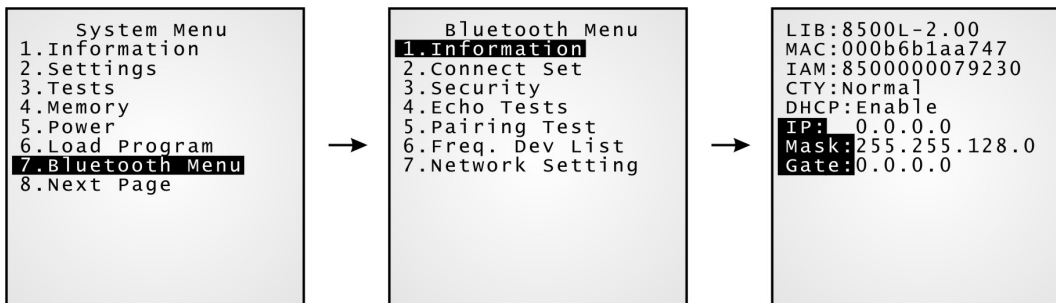

Bluetooth Menu | 1. Information

| | |
|-------------|---|
| LIB | C library version |
| MAC | MAC address of the Bluetooth module |
| IAM | A name given to the mobile computer for identification <ul style="list-style-type: none"> ▶ By default, it is made up of model number and the serial number. (Identical to 2. Connect Set 1. Local Name) |
| CTY | "Normal" means all 79 channels are available for frequency-hopping <ul style="list-style-type: none"> ▶ There are bandwidth limitations for 2.4 GHz ISM band in some countries. For example, only 23 RF channels are defined instead of 79 RF channels in Japan, Spain and France. |
| DHCP | DHCP server in use or not <ul style="list-style-type: none"> ▶ It will automatically become enabled while connecting to a BT-GPRS AP. |
| IP | IP address of the mobile computer |
| Mask | Subnet Mask |
| Gate | Default Gateway |

3.7.2 CONNECT SETTING

Set the connection parameters if necessary.



Local Name

Enter a name for identifying the mobile computer.

- ▶ By default, it is made up of model number and the serial number.

Remote Name

Enter a name for making a specific connection.

- ▶ The remote name must be one of those in the Freq. Dev. List. Otherwise, the mobile computer will fail to make a connection with any device without pairing.
- ▶ DO NOT specify any remote name when roaming across different groups of APs is required.

Broadcast Me

Options — Enable or Disable

- ▶ For initial connection, broadcasting must be enabled so that other Bluetooth devices can discover the mobile computer.
- ▶ For security concerns, you may disable it in future use to hide the mobile computer from other Bluetooth devices.

Power Saving

This refers to the low power consumption mode.

Options — Enable or Disable (Only the Sniff mode is supported.)

BT-GPRS AP Name

For DUN-GPRS mode, enter the AP name for connecting to the content server.

3.7.3 SECURITY

Set or modify security parameters.

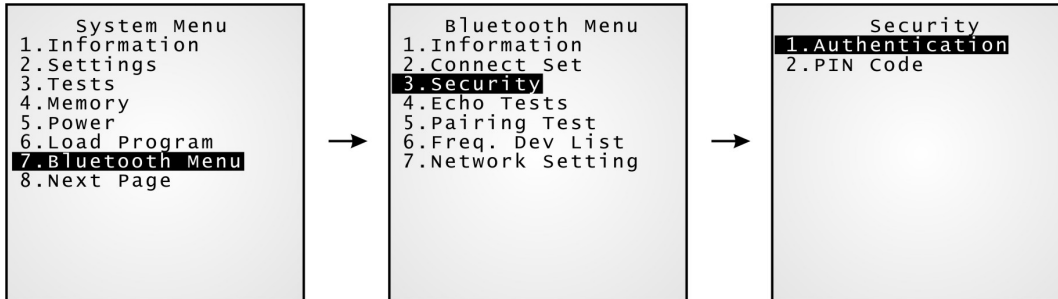

Authentication

Options — Enable or Disable

PIN Code

Define the encryption key values.

- ▶ Up to 16 characters, using ASCII code.

Note: When authentication is enabled without providing a pre-set PIN code, the mobile computer supports dynamic input of PIN code during pairing.

3.7.4 ECHO TESTS

These echo tests are used for verifying connectivity to make sure the mobile computer is within coverage. Press [ESC] to stop and exit the test.

In PAN mode, the echo test helps measure the coverage of the range, estimate the number of APs and mobile computers needed, and determine the topology of deploying APs.

- ▶ SPP: Serial Port Profile
It is used for ad hoc networking, without going through any access point.
- ▶ DUN: Dial-Up Networking Profile
DUN Modem - It makes use of a Bluetooth modem or mobile phone as a wireless modem.
DUN GPRS - It makes use of a mobile phone with GPRS functionality and connects to GPRS AP.
- ▶ HID: Human Interface Device Profile
It is used for the mobile computer to work as an input device, i.e. keyboard, for a host computer.
- ▶ BNEP: Bluetooth Network Encapsulation Protocol
It is used by Personal Area Networking Profile (PAN) for IP networking over Bluetooth.

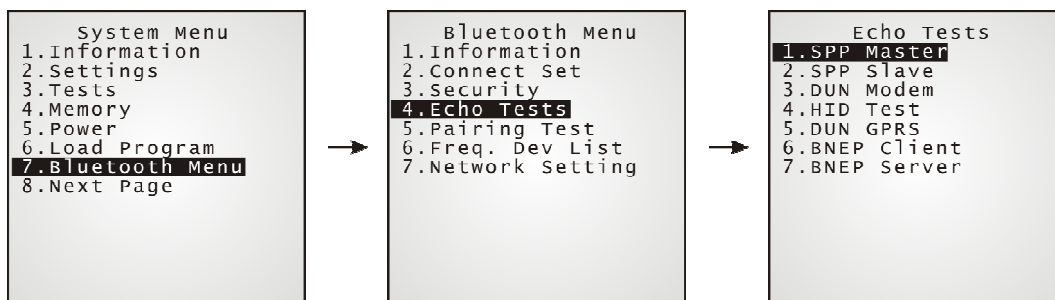

SPP Master

Set the mobile computer as a master device.

1. Pairing with your computer (slave) must be completed first.
2. Run the utility "EchoTest.exe" on your computer. Associated settings include
 - Select "RS-232" for interface.
 - Use the Bluetooth COM port that has been paired.
 - Set Action Mode to "Passive".
3. Start the echo test on both ends. The mobile computer will try to connect to PC (slave).

SPP Slave

Set the mobile computer as a slave device.

1. Enable Authentication and set your PIN code on the mobile computer.
2. Run the utility "EchoTest.exe" on your computer. Associated settings include
 - Select "RS-232" for interface.
 - Use the Bluetooth COM port that has been configured as "outgoing".
 - Set Action Mode to "Passive".
3. Start the echo test on both ends.
4. The mobile computer will wait for PC (master) to start the connection.
5. Enter the preset PIN code for authentication on your computer.

DUN Modem

The mobile computer will try to connect to a Bluetooth modem or mobile phone.

1. Pairing with your mobile phone must be completed first.
Select "DialUp Network" for Target Machine options.
2. Run the utility "EchoTest.exe" on your computer. Associated settings include
 - Select "Modem" for interface.
 - Set Action Mode to "Passive".
3. Start the echo test on both ends.
4. The mobile computer will connect to your mobile phone that dials up to your computer.

HID Test

Set the mobile computer as an input device.

1. The mobile computer will wait for PC to start the connection.
It is suggested to disable Authentication on the mobile computer.
2. Run a text editor on your computer.
3. Start to input data via the keypad on the mobile computer.

DUN GPRS

The mobile computer will try to connect to a mobile phone with GPRS functionality.

1. Pairing with your mobile phone must be completed first.
Select "DialUp Network" for Target Machine options.
2. Run the utility "EchoTest.exe" on your computer. Associated settings include
 - Select "TCP/IP – Server" for interface.
 - Set Action Mode to "Passive".
3. Start the echo test on both ends.
4. Enter the server IP and port number on the mobile computer.
5. The mobile computer will connect to your mobile phone that dials up a GPRS AP, and finally connect to your computer (server) through the GPRS AP.

BNEP Client

Set the mobile computer as a client.

1. Pairing with an AP must be completed first.
Select "Access Point" for Target Machine options.
Note that you must disable Authentication and clear the preset PIN code when connecting to Bluetooth AP (3560).
2. Run the utility "EchoTest.exe" on your computer. Associated settings include
 - Select "TCP/IP – Server" for interface.
 - Set Action Mode to "Passive".
3. Start the echo test on both ends.
4. Enter the server IP and port number on the mobile computer. The mobile computer will try to connect to an AP.

BNEP Server

Set the mobile computer as a server.

1. Pairing with an AP must be completed first.
Select "Access Point" for Target Machine options.
Note that you must disable Authentication and clear the preset PIN code when connecting to Bluetooth AP (3560).
2. Run the utility "EchoTest.exe" on your computer. Associated settings include
 - Select "TCP/IP – Client" for interface.
 - Enter Remote IP and port number.
 - Set Action Mode to "Passive".
3. Start the echo test on both ends. The mobile computer will try to connect to an AP.

3.7.5 PAIRING TEST

The pairing procedure is for the creation and exchange of a link key between two Bluetooth-enabled devices. The devices use the link key for future authentication when exchanging information.

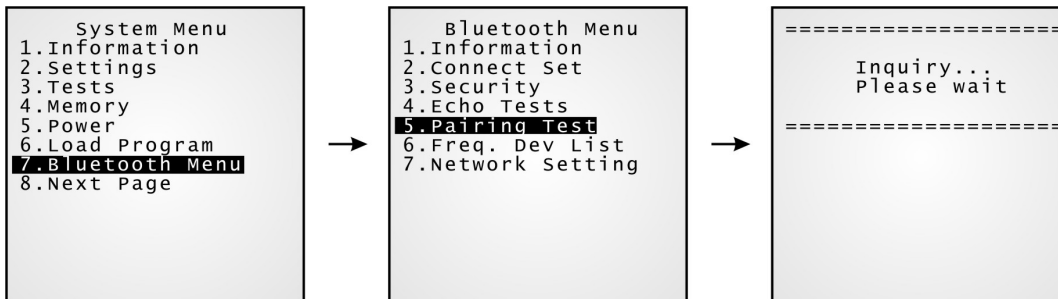

- 1) The mobile computer will start with making an inquiry so that the system can generate a list of device(s) that has been discovered nearby.
- 2) Select a desired target device.
For the device name, it can only display a maximum length of 11 characters. When the device name is too long, it will be truncated automatically.
- 3) Select a Bluetooth service from the "Target Machine" menu. To stop and exit the test, press [ESC].

After pairing successfully, the target device will be added to the Frequent Device List for quick connection in the future.

Note: For the initial use of Bluetooth networking, the pairing procedure must be done before the Echo tests.

3.7.6 FREQ. DEV. LIST

The Frequent Device List is used to store a list of target device(s) that the mobile computer has been connected to lately. After each successful pairing, the system will update the list.

Note: To unpair any device, simply delete the device from this list.



This list can show information of up to eight target devices that provides different Bluetooth services. For the device name, it can only display a maximum length of 11 characters. When the device name is too long, it will be truncated automatically.

- ▶ It can list only one device that provides the Bluetooth Serial Port service. (SPP)
- ▶ It can list up to eight APs that provide the Bluetooth Personal Area Networking service. (PAN)
- ▶ It can list only one device that provides the Bluetooth Dial-Up Networking service. (DUN)
- ▶ It can list only one device that provides the Human Interface Device (HID)

However, if you access the list via **Kernel Menu**, it can only show information of the target device connected via SPP.

Note: During roaming (for PAN only) or re-establishing the connection, the mobile computer will automatically connect to the listed AP(s) or target device without going through the pairing procedure.

3.7.7 NETWORK SETTING

Set parameters for IP networking.



DHCP

Options — Enable or Disable

Subnet Mask

Enter a new Mask IP, if necessary.

Local IP Address

Enter a new address for the mobile computer, if necessary.

Default Gateway

Enter a new address for the default Gateway, if necessary.

DNS Server

Enter a new address for the DNS server, if necessary.

Domain Name

The domain name of the host is displayed when DHCP server is enabled.

Note: Normally, DHCP is enabled and all of the settings can be obtained from the DHCP server.

3.8 SERIAL PPP MENU

This submenu is for establishing a PPP connection via the Modem Cradle. You must configure these parameters correctly.

- ▶ Point-to-Point Protocol (PPP) is a method of connecting the mobile computer to the Internet over serial links. It sends TCP/IP packets to a server that connects to the Internet.

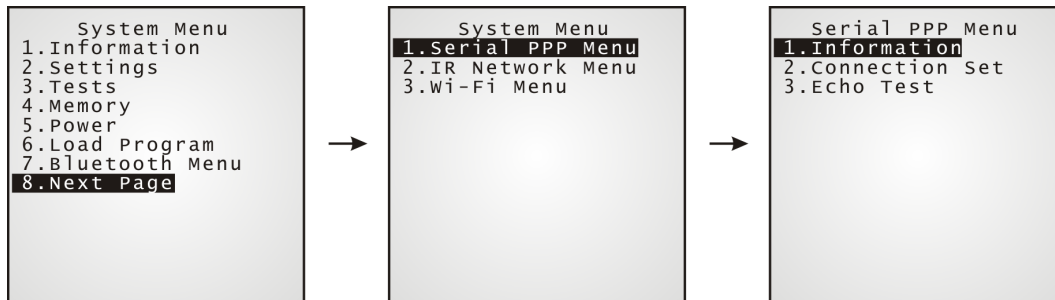

3.8.1 INFORMATION

Information of library version can be viewed here.

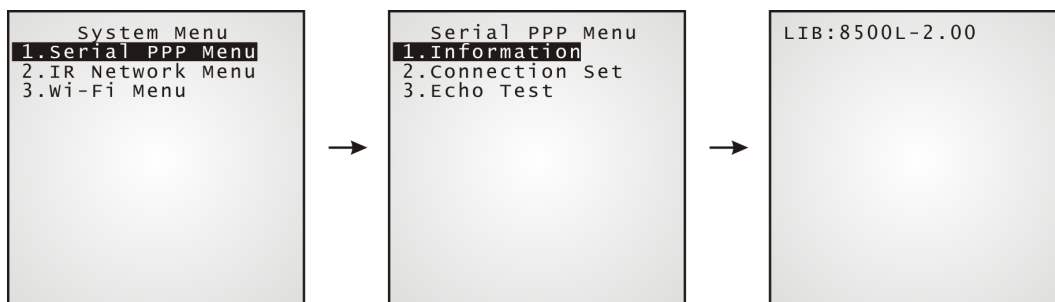

Serial PPP Menu | 1. Information

LIB C library version

- ▶ Identical to **System Menu | 1. Information**

3.8.2 CONNECTION SET

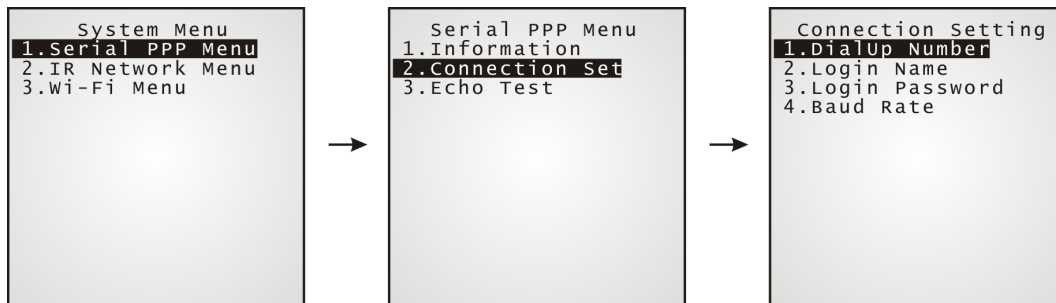

DialUp Number

Enter the number provided by your ISP.

Login Name

Enter the login name provided by your ISP.

Login Password

Enter the login password provided by your ISP.

Baud Rate

Select a desired baud rate.

Note: By default, the baud rate is set to 57600 bps on the Modem Cradle.
For any other value, such as 115200/38400/19200/9600, you must configure through the DIP switch on the IR control board.

3.8.3 ECHO TEST

This echo test is used for verifying connectivity via Point-to-Point Protocol. For the Modem Cradle, its physical connectivity can be verified in **System Menu | Tests | Echo Test | IR** or **MODEM**.

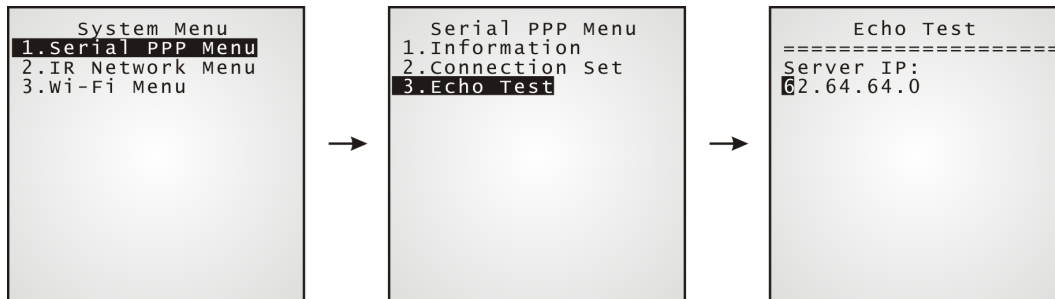

Note: Enter the IP address of a server with which a PPP connection is desired. Then, it will try to connect to the server. After the PPP connection is established properly, run the utility "EchoTest.exe" on your computer (TCP/IP – Server), and then, start this test on your mobile computer.

3.9 IR NETWORK MENU (ETHERNET VIA IR)

This submenu is for establishing an Ethernet connection via IR networking. You must configure these parameters correctly.

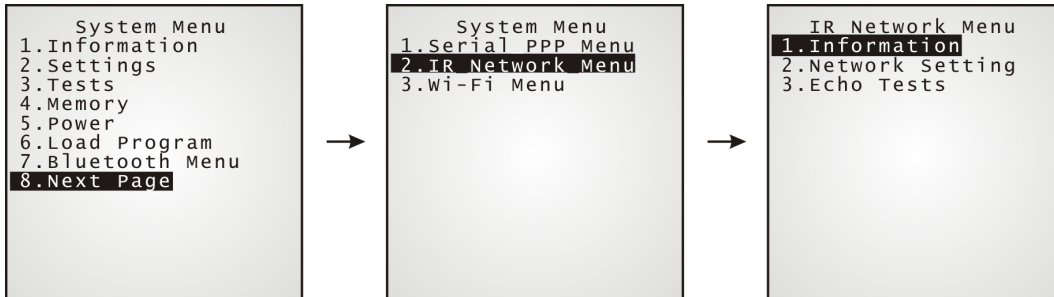

Note: The Ethernet Cradle is required for establishing Ethernet connection via IR.

3.9.1 INFORMATION

Information of Ethernet network configuration can be viewed here.

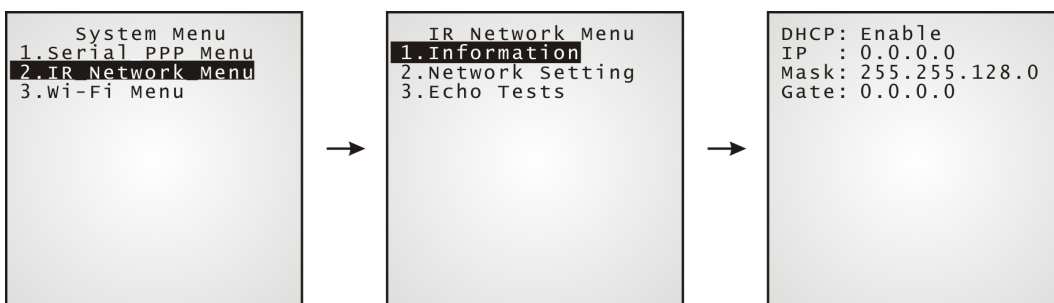

IR Network Menu | 1. Information

| | |
|-------------|-----------------------------------|
| DHCP | DHCP server in use or not |
| IP | IP address of the mobile computer |
| Mask | Subnet Mask |
| Gate | Default Gateway |

3.9.2 NETWORK SETTING

Set parameters for IP networking.

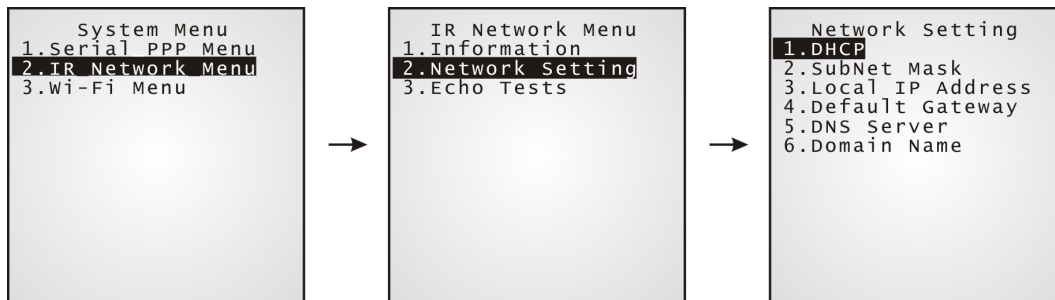

DHCP

Options - Enable or Disable

Subnet Mask

Enter a new Mask IP, if necessary.

Local IP Address

Enter a new address for the mobile computer, if necessary.

Default Gateway

Enter a new address for the default Gateway, if necessary.

DNS Server

Enter a new address for the DNS server, if necessary.

Domain Name

The domain name of the host is displayed when DHCP server is enabled.

Note: Normally, DHCP is enabled and all of the settings can be obtained from the DHCP server.

3.9.3 ECHO TESTS

The Ethernet Cradle supports three working modes:

- ▶ Data Mode
- ▶ Modem Mode
- ▶ Transparent Mode

These echo tests are used for verifying connectivity via the Ethernet Cradle. For details, refer to the Ethernet Cradle manual.

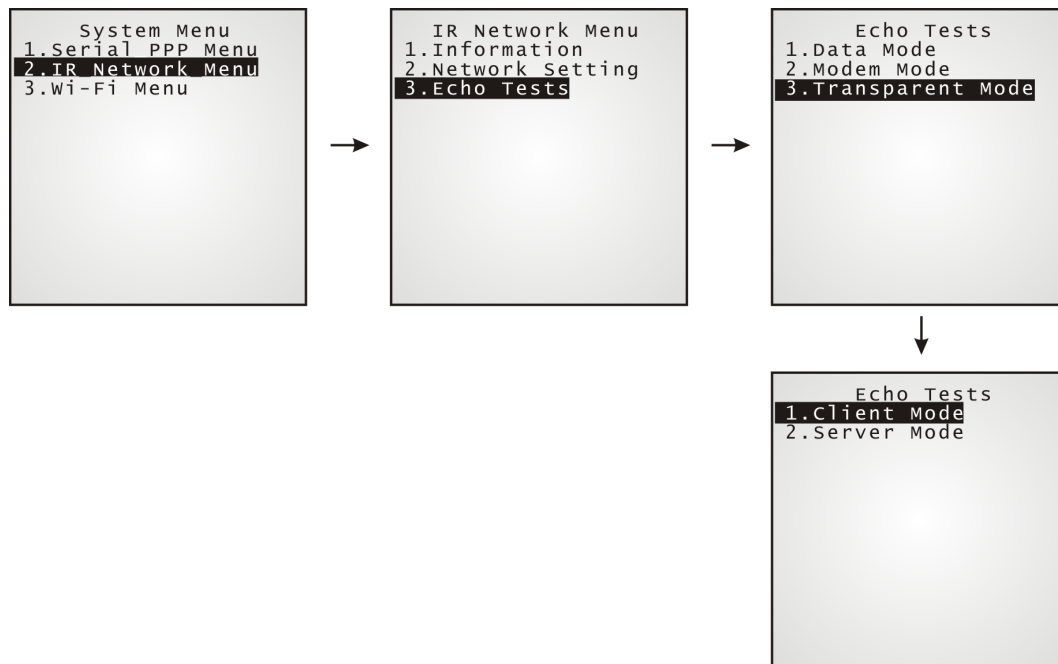

Data Mode

Set the Ethernet Cradle in Data mode. The mobile computer works as a client.

Modem Mode

Set the Ethernet Cradle in Modem mode. The mobile computer works as a client.

Transparent Mode

1. Client Mode - Set the mobile computer as a client.
Enter the IP address of a server with which a connection is desired.
2. Server Mode - Set the mobile computer as a server that waits for other devices to connect to.

Note: After the Ethernet connection is established properly, run the utility "EchoTest.exe" on your computer (TCP/IP – Server or Client), and then, start this test on your mobile computer.

3.10 WI-FI MENU

This submenu is for 802.11b/g wireless networking. You must configure these parameters correctly.

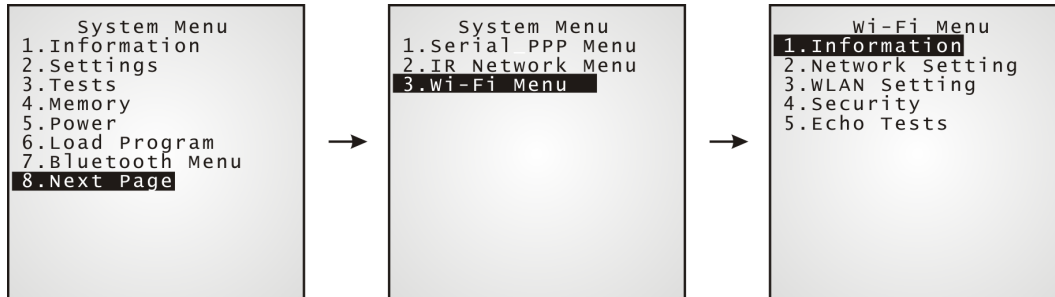

Note: The menu is available only when the Wi-Fi module is present.

| Wi-Fi Settings | Default Value | Ad-hoc | Infrastructure |
|------------------------|------------------------|---------------------------------|----------------|
| Network Setting | | Items Need to Be Checked | |
| DHCP | Enabled | --- | v |
| SubNet Mask | 255.255.128.0 | v | v |
| Local IP Address | 0.0.0.0 | v | v |
| Default Gateway | 0.0.0.0 | --- | v |
| DNS Server | 0.0.0.0 | --- | v |
| Domain Name | --- | --- | v |
| WLAN Setting | | | |
| Local Name | Model no. + Serial no. | v | v |
| SS ID | --- | --- | v |
| System Scale | Medium | --- | v |
| Power Saving | Enabled | --- | v |
| Preamble | Long | --- | v |
| Ad-Hoc | Disabled | v | --- |
| Fixed BSSID | 000000000000 | --- | v |
| Security | | | |
| Authentication | Open System | --- | v |
| WEP Menu | Disabled | --- | v |
| EAP Menu | Disabled | --- | v |
| WPA Menu | Disabled | --- | v |

3.10.1 INFORMATION

Information of network configuration can be viewed here.

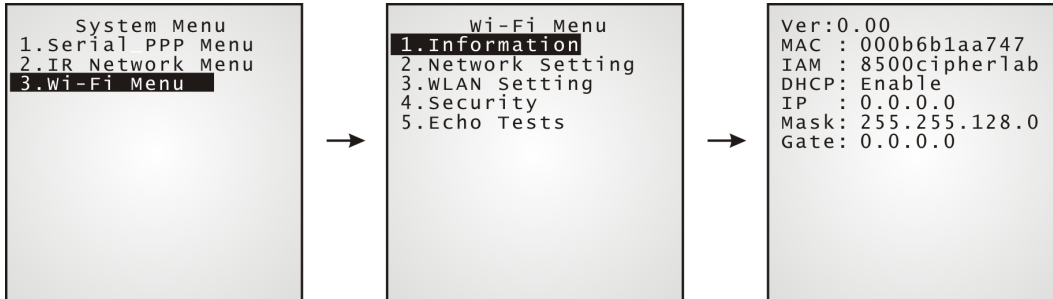

Wi-Fi Menu | 1. Information

| | |
|-------------|---|
| Ver | Firmware version of the Wi-Fi module |
| MAC | MAC address of the Wi-Fi module |
| IAM | A name given to the mobile computer for identification. <ul style="list-style-type: none"> ▶ By default, it is made up of model number and the serial number. (Identical to 3. WLAN Setting 1. Local Name) |
| DHCP | DHCP server in use or not |
| IP | IP address of the mobile computer |
| Mask | Subnet Mask |
| Gate | Default Gateway |

3.10.2 NETWORK SETTING

Set parameters for IP networking.

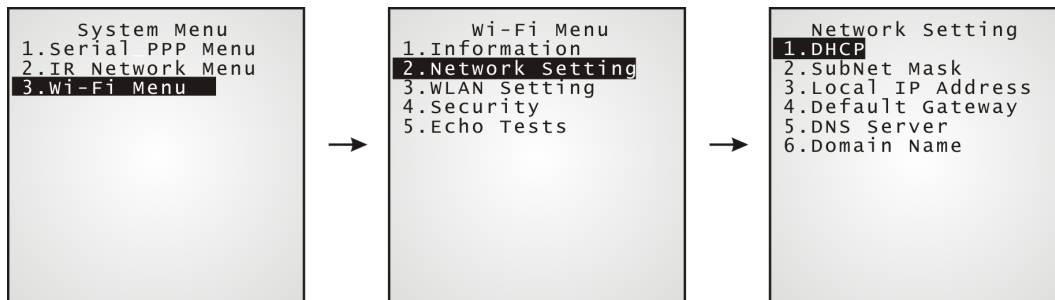

DHCP

Options — Enable or Disable

Subnet Mask

Enter a new Mask IP, if necessary.

Local IP Address

Enter a new address for the mobile computer, if necessary.

Default Gateway

Enter a new address for the default Gateway, if necessary.

DNS Server

Enter a new address for the DNS server, if necessary.

Domain Name

The domain name of the host is displayed when DHCP server is enabled.

Note: Normally, DHCP is enabled and all of the settings can be obtained from the DHCP server.

3.10.3 WLAN SETTING

Wireless networking can operate in two modes – (1) Ad-hoc mode: peer-to-peer, and (2) Infrastructure mode: point to multi-point through access points.

Set the following parameters.

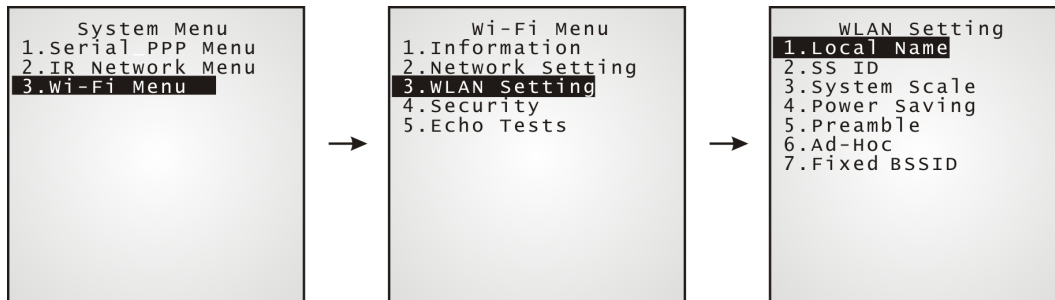

Local Name

Enter a name for identifying the mobile computer.

- ▶ By default, it is made up of model number and the serial number.

SS ID

This refers to Service Set Identifier or AP name, which is used for remote device association.

- ▶ The mobile computer can ONLY communicate with access points that have the same SS ID.

System Scale

This refers to Access Point Density.

Options — [1] Low [2] Medium [3] High

- ▶ The value you set must match that set for the access point.
- ▶ “Low / Medium / High” means the mobile computer will search for other APs only when data transmission rate drops below “1 / 2 / 5” Mbps individually.

Power Saving

This refers to the low power consumption mode.

Options — Enable or Disable

- ▶ The value you set must match that set for the access point.

Preamble

Options — [1] Long [2] Short [3] Both

- ▶ The value you set must match that set for the access point.

Ad-Hoc

This refers to peer-to-peer mode, without going through access points.

Options — Enable or Disable

Fixed BSSID

This refers to the use of a specific AP's MAC address as the fixed Basic Service Set Identifier.

- ▶ The mobile computer can ONLY communicate with this one and only access point.

3.10.4 SECURITY

Set or modify security parameters.

- ▶ WEP: Wired Equivalent Privacy
- ▶ EAP: Extensible Authentication Protocol
- ▶ WPA: Wi-Fi Protected Access

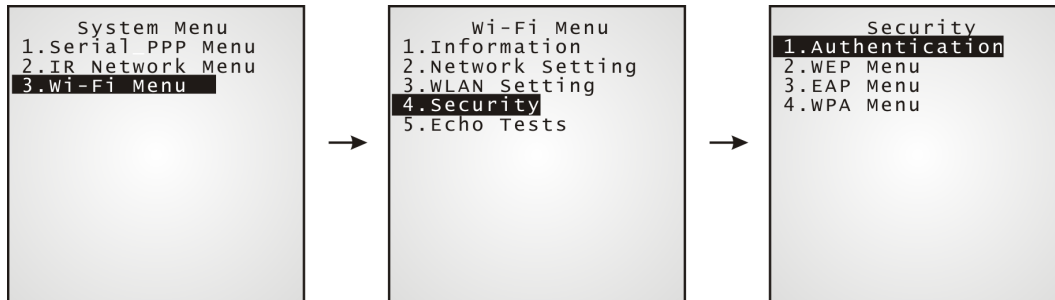

Authentication

- [1] Open System ▶ Default authentication type
- [0] Share Key ▶ This requires implementing WEP key.

WEP Menu

- WEP Setting ▶ Enabled (For Share Key, it must be enabled!)
▶ Disabled (default)
- WEP Key Length ▶ 64 bits
▶ 128 bits (default)
- Default Key WEP KEY1
- WEP Key Enter WEP Keys 1 ~ 4 in one of the following input data type:
 - ▶ ASCII (up to 13 characters)
 - ▶ Hexadecimal (up to 26 characters)

EAP Menu (for associating to Cisco access points)

- EAP Setting ▶ Enabled
▶ Disabled (default)
- EAP ID Enter a user name (up to 32 characters)
- EAP Password Enter a password (up to 32 characters)

WPA Menu (WPA-PSK)

- WPA Setting ▶ Enabled
▶ Disabled (default)
- WPA Passphrase Enter a phrase as your password (8 ~ 63 characters)

3.10.5 ECHO TESTS

This function is used to measure the coverage of the range, estimate the number of APs and mobile computers needed, and determine the topology of deploying APs.

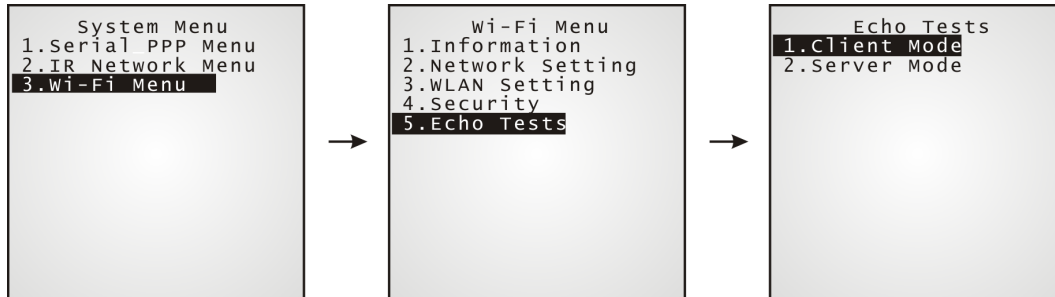

Client Mode

Set the mobile computer as a client. Enter the IP address of a server with which a connection is desired. Then, it will try to connect to an AP.

1. Run the utility "EchoTest.exe" on your computer. Associated settings include
 - Select "TCP/IP – Server" for interface.
 - Set Action Mode to "Passive".
2. Start the echo test on both ends.
3. Enter the server IP and port number on the mobile computer.

Server Mode



Set the mobile computer as a server. The mobile computer will try to connect to an AP.

1. Run the utility "EchoTest.exe" on your computer. Associated settings include
 - Select "TCP/IP – Client" for interface.
 - Set Action Mode to "Passive".
2. Start the echo test on both ends.

While running echo tests, if WPA setting is enabled for security, the SSID and Passphrase will be processed to generate a pre-share key.

Note: If you change the SSID or Passphrase, it will have to re-generate a pre-share key.

- 1) For initial association with an access point, you will see an antenna icon developing on the screen to indicate that the mobile computer is processing a pre-share key.
- 2) After having generated the pre-share key, the mobile computer proceeds to establish a connection with an access point, and you will see the whole antenna is flashing.
- 3) When the mobile computer has been connected to the access point successfully, you will see the whole antenna and the indication of wireless signal strength.

The changing icon -    indicates 8500 is processing a pre-share key.
Wait for a few seconds.

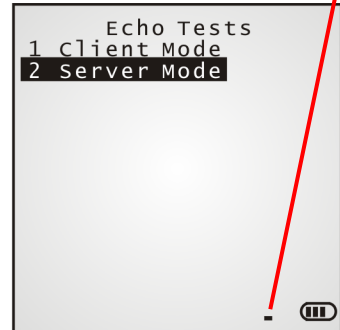
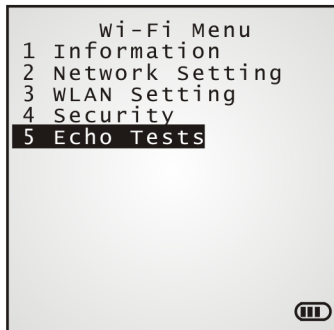

The antenna icon will become ready and flashes to indicate 8500 is connecting to an access point under the same SSID.

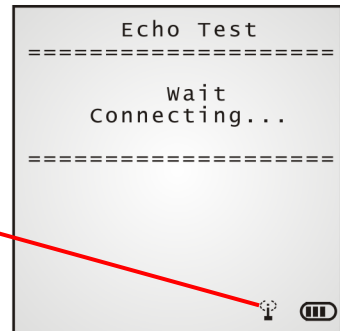

Once connected, the antenna icon will stop flashing. Next to the icon, the more bars, the stronger the signal.

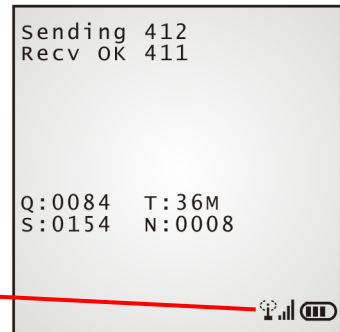

Note: If you are programming in C or BASIC, be aware that the antenna will appear on the device screen after NetInit() or START TCPIP() is called. (WPA must be enabled first!)

Once the connection of echo test is established, the details will be displayed as illustrated below. Link Quality ("Q") will be the most important element while the others are for your reference.



| Q (Link Quality) | | T (Transmit Speed) | | S (Signal Level) | | N (Noise Level) | |
|------------------|-----------|--------------------|------|------------------|----------|-----------------|----------|
| 0 ~ 10 | Very Poor | 1 | Mbps | 0 ~ 30 | Weak | 1 | Weak |
| 10 ~ 15 | Poor | 2 | Mbps | 30 ~ 60 | Moderate | 2 ~ 3 | Moderate |
| 15 ~ 30 | Good | 5.5 | Mbps | Over 60 | Strong | 4 ~ 5 | Strong |
| 50 ~ 80 | Very Good | 11 | Mbps | | | | |
| | Good | 6 | Mbps | | | | |
| | | 9 | Mbps | | | | |
| | | 12 | Mbps | | | | |
| | | 18 | Mbps | | | | |
| | | 24 | Mbps | | | | |
| | | 36 | Mbps | | | | |
| | | 48 | Mbps | | | | |
| | | 54 | Mbps | | | | |

PROGRAM MANAGER & KERNEL

This chapter explains **Program Manager** and **Kernel** that manage multiple programs and firmware upgrade.

IN THIS CHAPTER

| | |
|---------------------------|----|
| 4.1 Program Manager | 79 |
| 4.2 Kernel | 84 |

4.1 PROGRAM MANAGER

The mobile computer supports multiple applications and languages. In the menu of **Program Manager**, it allows storing up to seven programs and has one activated for the current use.

If there is no application program exists, the **Program Manager** will be displayed after you turn on the mobile computer.

Warning! Program Manager is provided for managing programs in an administrative level.

How to access Program Manager?

- 1) Turn off the mobile computer.
- 2) Press [8] + [Power].



4.1.1 DOWNLOAD

Here provides a full list of programs that are currently stored on the mobile computer with size information. Multiple application programs can be downloaded through a variety of interfaces. Upon completion of downloading, you are allowed to input a name for the program. If there is no need to rename the program, simply press [ENTER] to leave as it is.

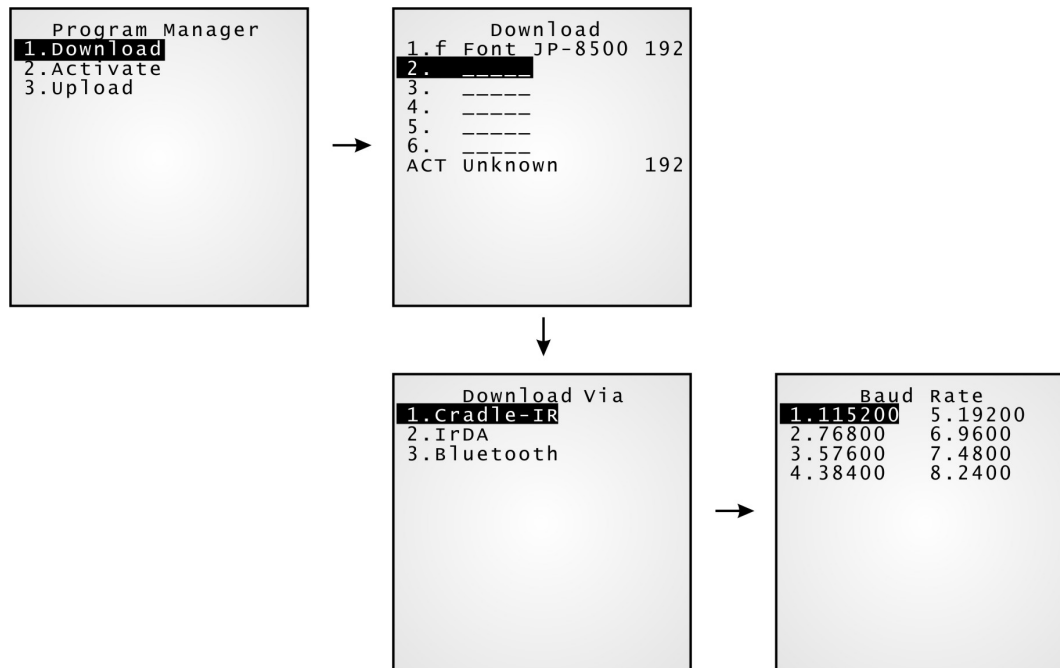

The length of program name can be up to 12 characters. Program size is in kilobytes.

A suffix letter after the memory sector (1 ~ 6) indicates the file type of program.

- ▶ "b" for BASIC program (.SYN)
- ▶ "c" for C program (.SHX)
- ▶ "f" for font file (.SHX)

Note: (1) For a BASIC program (.SYN), it can only be downloaded via **System Menu**.
 (2) In addition to the system font, there can be only one font file downloaded to the mobile computer. The custom font file needs to be downloaded via **System Menu** or **Kernel Menu**.

SPARE MEMORY SECTORS (1 ~ 6)

Additional program files can be directly downloaded to these sectors.

Download a program file to an empty sector:

1. Press the arrow keys [Up] and [Down] to select an empty sector, and then press [ENTER].
2. Select a desired interface for downloading.
3. Connect the interface cable if required, and wait for a few seconds to establish a connection...
4. To abort the action, press [ESC]. Then press [ESC] again to return to the menu.

Download a program file to an occupied sector:

If no available sectors, you'll have to replace one program with the new one.

1. Press the arrow keys [Up] and [Down] to select a program that you want to delete, and then press [ENTER].
2. The program information is displayed on the screen.
Press the modifier key [ALPHA] or [Alpha] to enter the Alpha mode:
 - ▶ Press the capital letter [C] and follow the steps below to download a program file.
 - ▶ Press the capital letter [D] if you simply want to delete the program.
3. Select a desired interface for downloading.
4. Connect the interface cable if required, and wait for a few seconds to establish a connection...
5. To abort the action, press [ESC]. Then press [ESC] again to return to the menu.

From the menu, you'll see the program has been deleted but no new program is present (because you have canceled the download action).

ACTIVE MEMORY SECTOR ("ACT")

Only the application program, which needs to be activated immediately, can be downloaded to the active memory sector.

Download to Memory Sector "ACT":

1. Press the arrow key [Down] to select the memory sector "ACT" (may be unoccupied), and then press [ENTER].
2. Select a desired interface for downloading.
3. Connect the interface cable if required, and wait for a few seconds to establish a connection...

If the active memory sector has already been occupied by an application program, the newly downloaded program will replace the currently active program and come into effect immediately.

4.1.2 ACTIVATE

The list shows the entire spare programs stored on the mobile computer. From the list, you can select from the memory sector (1 to 6). The selected program will be copied to the active memory sector and replace the current one.

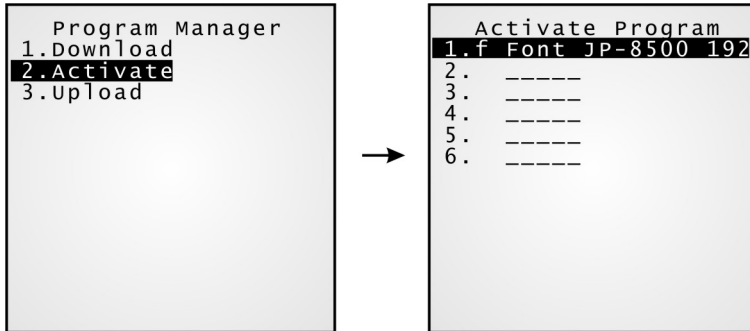

Note: A font file cannot be activated.

TO CLEAR FILE SYSTEM

When <New Program Start> screen appears, "Press [ESC] to clear file" means the file system in the SRAM will be cleared out by pressing [ESC]. Then there will be no data (transactions, settings, etc.) stored on the mobile computer when the new program comes into effect.

TO KEEP FILE SYSTEM

To keep the data, simply press any other key.

4.1.3 UPLOAD

You may duplicate one or all of the programs from the mobile computer to a host computer or another mobile computer. This can be used to clone software on mobile computers.

Note: To clone all of the programs, the target mobile computer cannot have any other program downloaded except the active one; that is, Memory Sectors 1 ~ 6 must be empty!

The procedures are similar to that for downloading programs.

This screen is not available if you select "2.All Programs" from the previous screen.

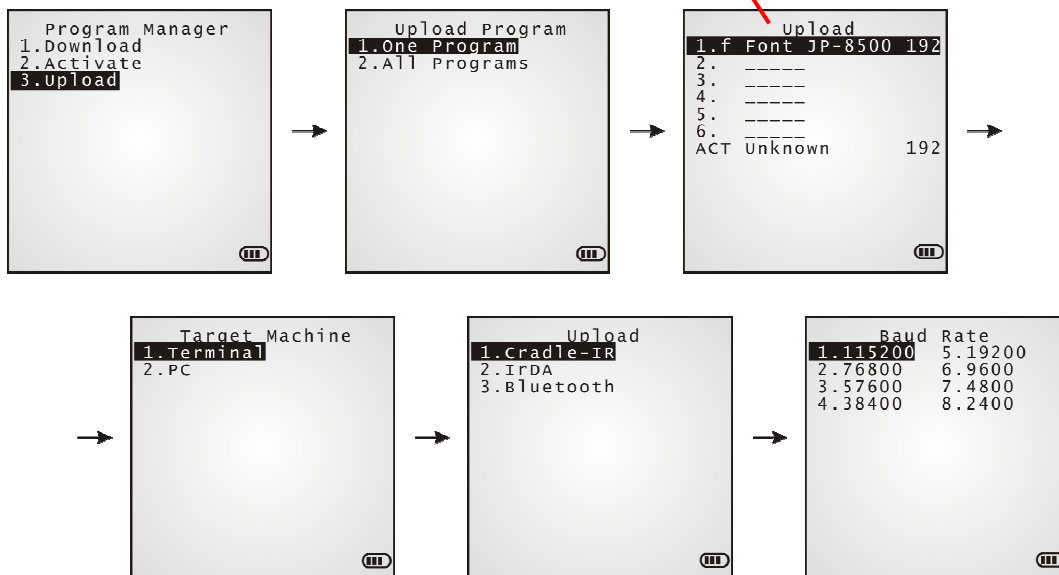

4.2 KERNEL

The kernel resides in the innermost core of the system. It has the highest security and is always protected by the system. When the application program is corrupted and **System Menu** fails at the same time, **Kernel Menu** provides an access to fix the system.

Warning! Kernel Menu is NOT for the use of any end users.

How to access Kernel Menu?

- 1) When the last session is in **System Menu** or **Program Manager**, simply turn off the mobile computer. Otherwise, you must reload the battery pack.
- 2) Press [1] + [7] + [Power].



4.2.1 KERNEL INFORMATION

Here provides important system information to help diagnose the system.

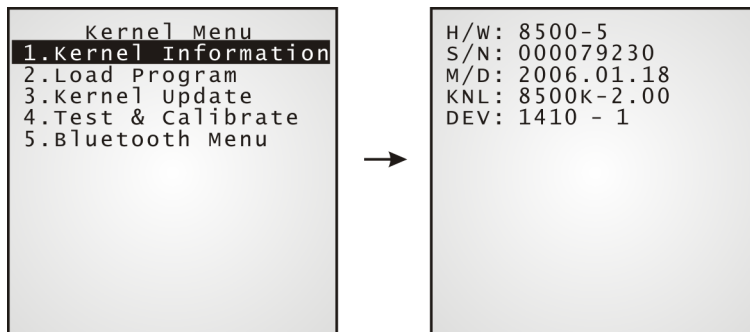

Kernel Menu | 1. Information

| | |
|------------|---|
| H/W | Hardware version |
| S/N | Serial number of the mobile computer |
| M/D | Manufacturing date |
| KNL | Kernel version |
| DEV | 5-digit code for optional hardware configurations Refer to Understanding Device Code . |

4.2.2 LOAD PROGRAM

You can download one program file to the active memory sector, as well as one font file to the memory address assigned by the system. After downloading, restart the mobile computer to activate the new program. Refer to [Appendix I Download Utility](#).

- ▶ New application program or program update
- ▶ And/or one font file, i.e. multi-language font

If you are using a custom font file rather the system font and you want to download another font file, it is necessary to delete the current font file from the program list displayed by [Program Manager](#) first. Otherwise, downloading new font file is not allowed.

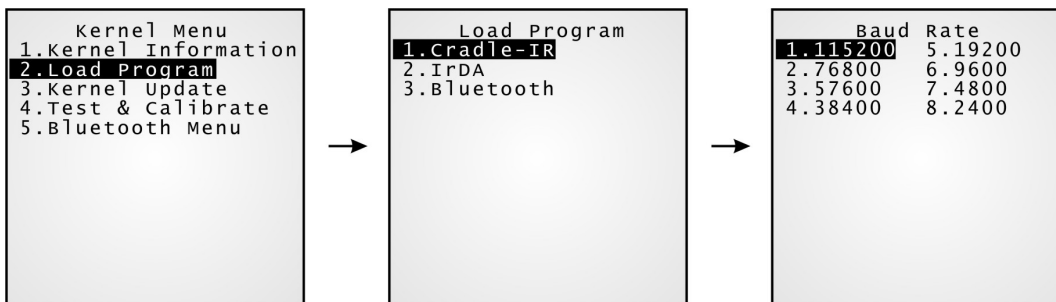

Note: The mobile computer will stay in download mode for approximately 30 seconds.

.SHX Program

Download one of the following C program files and/or font file:

Program File

- ▶ AG Runtime: U8500.shx (Batch AG)
WU8500.shx (WLAN AG)
- ▶ CipherNet Runtime: 85xx-5250.shx (CipherNet-5250)
85xx-VT.shx (CipherNet-VT)
- ▶ BASIC Runtime^{Note}: B8500.shx
- ▶ User program

Font File

Refer to the Font Files folder on CD-ROM.

If you have downloaded a BASIC Runtime program, the next time you access the [Load Program](#) service via **System Menu**, you will be able to select whether to download a C program (.SHX) or BASIC program (.SYN).

Note: Go to **System Menu** | **6. Load Program** | **2. Load Basic**, and download a BASIC program (*SYN).

SETTINGS
Interface

| Options | Description |
|-----------------------|---|
| Cradle-IR (Serial IR) | Proceed to configure baud rate settings on your computer and the mobile computer. |
| IrDA | Point to the target IrDA device. |
| Bluetooth | Approach the target Bluetooth enabled device. |

Baud Rate

| Options | Supported by CipherLab software, including download utilities | |
|--------------|---|----|
| 115200 (bps) | Yes | |
| 76800 (bps) | | No |
| 57600 (bps) | Yes | |
| 38400 (bps) | Yes | |
| 19200 (bps) | Yes | |
| 9600 (bps) | Yes | |
| 4800 (bps) | | No |
| 2400 (bps) | | No |

Note: If you select to use Serial IR of the Modem Cradle, any value other than 57600 bps (default) must be configured through the DIP switch on the IR control board.

LOAD PROGRAM VIA BLUETOOTH

- 1) Go to **Kernel Menu | 5. Bluetooth Menu | 3. Security**, and configure the following Bluetooth settings first.
 - ▶ Authentication
 - ▶ PIN code
- 2) Go to **Kernel Menu | 2. Load Program** and select Bluetooth.
- 3) Start the pairing procedure from your computer, for example, click [Pair Device] and/or [Connect Bluetooth Serial Port].
- 4) Run the download utility: ProgLoad.exe
 - Select interface RS-232/IrDA for using Bluetooth SPP.
 - Select COM port properties that match with the serial port settings used on your computer.

4.2.3 KERNEL UPDATE

The kernel might need to be updated to improve performance or due to other considerations.

- ▶ To download a kernel update (K*.shx), the procedure is the same as that for downloading a program.
- ▶ Any attempt to download an older version will be rejected.
- ▶ The system will restart itself right after downloading.

Warning: Do not turn off the mobile computer while downloading a kernel update or re-starting the mobile computer. Otherwise, it will crash the kernel forever. There is no way to recover it!

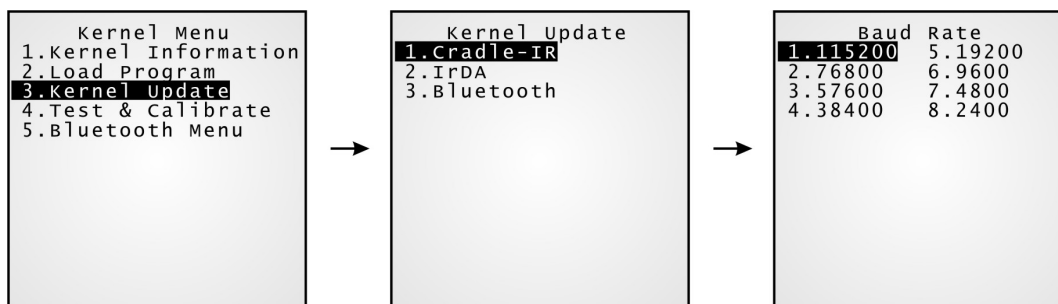

Note: CipherLab software, including download utilities, supports the following baud rate options: 115200/57600/38400/19200/9600 bps.

4.2.4 TEST & CALIBRATE

These tools are provided for manufacturing use.

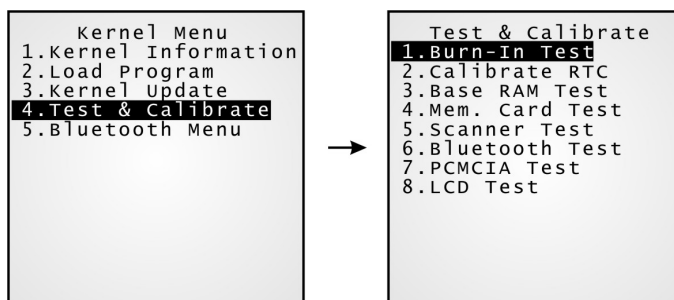

Warning! You should not perform any of these tests.

4.2.5 BLUETOOTH MENU

Refer to [3.7 Bluetooth Menu](#) for details. This submenu is almost the same as the one provided in **System Menu** except for a few items.

SPECIFICATIONS

| Model Designation | | 8500 | 8570 | | |
|-----------------------------------|--------------------|---|------|--|--|
| Wireless Communications | IR/IrDA | √ | √ | | |
| | Bluetooth Class 2 | √ | √ | | |
| | 802.11b/g | | √ | | |
| Readers | Barcode Reader | <ul style="list-style-type: none"> ▶ CCD (linear imager) ▶ Standard Laser ▶ Long Range Laser ▶ Extra Long Range Laser ▶ 2D Imager | | | |
| | RFID Reader | Frequency 13.56 MHz | | | |
| Electrical Characteristics | Main Battery | Rechargeable Li-ion battery – 3.7 V, 4000 mAh | | | |
| | Working Time | Laser, one scan per 5 seconds, with backlight on: <ul style="list-style-type: none"> ▶ 400 hours in batch mode ▶ 70 hours in Wi-Fi mode | | | |
| | Backup Battery | <ul style="list-style-type: none"> ▶ Rechargeable Lithium button cell – 3.0 V, 7 mAh ▶ Data retention – at least 7 days | | | |
| | Power Adaptor | <ul style="list-style-type: none"> ▶ Input: AC 100~240 V, 50/60 Hz ▶ Output: DC 6 V, 3.3 A ▶ Operating Temperature: 0 °C to 40 °C | | | |
| Physical Characteristics | CPU | 32-bit Toshiba CMOS type, 40 MHz | | | |
| | Memory | <ul style="list-style-type: none"> ▶ Program memory – 2 MB flash ▶ Data memory – 2 MB onboard SRAM, upgradeable (4 or 8 MB optional) | | | |
| | Display | Graphic LCD, 160 x 160 pixels, 3" FSTN with LED backlight programmable <ul style="list-style-type: none"> ▶ Font size 6x8: 26 characters by 19 lines ▶ Font size 8x16: 20 characters by 9 lines Also a touch screen allows for the use of stylus for control and signature capture. | | | |
| | Keypad | 24 or 44 rubber keys, LED backlight programmable | | | |
| | Indicators | <ul style="list-style-type: none"> ▶ LED – Dual-color (red/green), programmable ▶ Buzzer – Low power transducer type, 1 KHz to 4 KHz, programmable | | | |
| | Vibrator | 9000 ± 2000 RPM, Max. 50 dB, programmable | | | |
| | Enclosure Material | Rubber & ABS plastic | | | |

| | | |
|--------------------------------------|--------------------------|---|
| | Dimensions | 230 mm (L) 91 mm (W) 65 mm (H) |
| | Weight | Approx. 600 g (Laser, battery included) |
| Environmental Characteristics | Temperature | Operating: -20 °C to 60 °C (8500) -10 °C to 60 °C (8570) Storage: -30 °C to 70 °C |
| | Humidity | Operating: 10% to 90% non-condensing Storage: 5% to 95% non-condensing |
| | Impact Resistance | 1.5 m, 5 drops per 6 sides |
| | Splash / Dust Resistance | IP 64 |
| | Electrostatic Discharge | ± 15 kV air discharge, ± 8 kV contact discharge |
| Programming | Development Tools | C and BASIC |
| | Software & Utilities | FORGE Application Generator (AG), AG utilities; MIRROR Emulator (CipherNet) for VT100/220, IBM 5250 emulation; Download utilities, testing tools, etc. |
| Accessories | | <ul style="list-style-type: none"> ▶ Pistol Grip ▶ Belt Holster ▶ Protective Cover ▶ Spare rechargeable battery pack ▶ 4-slot Battery Charger ▶ Charging & Communication Cradle ▶ Modem Cradle (56 K) ▶ Ethernet Cradle (10/100 BASE-T) ▶ Vehicle Cradle ▶ Travel Charger |

DOWNLOAD UTILITY

For easy development of applications, the mobile computer ships with **FORGE Application Generator** programs, batch and WLAN versions, as well as a download utility.

FILE TYPES

Depending on the file type, you may download a program or font file via **System Menu**, **Program Manager** or **Kernel Menu**.

| File Type | System Menu | Kernel Menu | Program Manager |
|-------------------|-------------|-------------|-----------------|
| Font file | √ | √ | – |
| AG runtime | √ | √ | √ |
| CipherNet runtime | √ | √ | √ |
| Kernel update | – | √ | – |
| BASIC program | √ | – | – |
| BASIC runtime | √ | √ | √ |

FONT FILE

Download a font file (.SHX) via **System Menu** or **Kernel Menu**.

- ▶ Font file: Font-Multi-Language.SHX, Font-Japanese.SHX, and so on.

C PROGRAMS

Download a C program (.SHX) via **System Menu**, **Program Manager** or **Kernel Menu**.

- ▶ AG runtime: U8500.SHX, WU8500.SHX
- ▶ CipherNet runtime: 85xx-VT.SHX, 85xx-5250.SHX
- ▶ Kernel update: K*.SHX

Note: You can only download a Kernel update via **Kernel Menu**.

BASIC PROGRAMS

First, download a BASIC runtime (e.g. B8500.SHX) via **System Menu**, **Program Manager** or **Kernel Menu**. Then, it will allow you to download a BASIC program (.SYN) via **System Menu**.

PROGLOAD.EXE

The utility "ProgLoad.exe" is provided for you to download a program (*.SHX or *.SYN) to the mobile computer. Run the program on your computer. The following dialog box pops up.

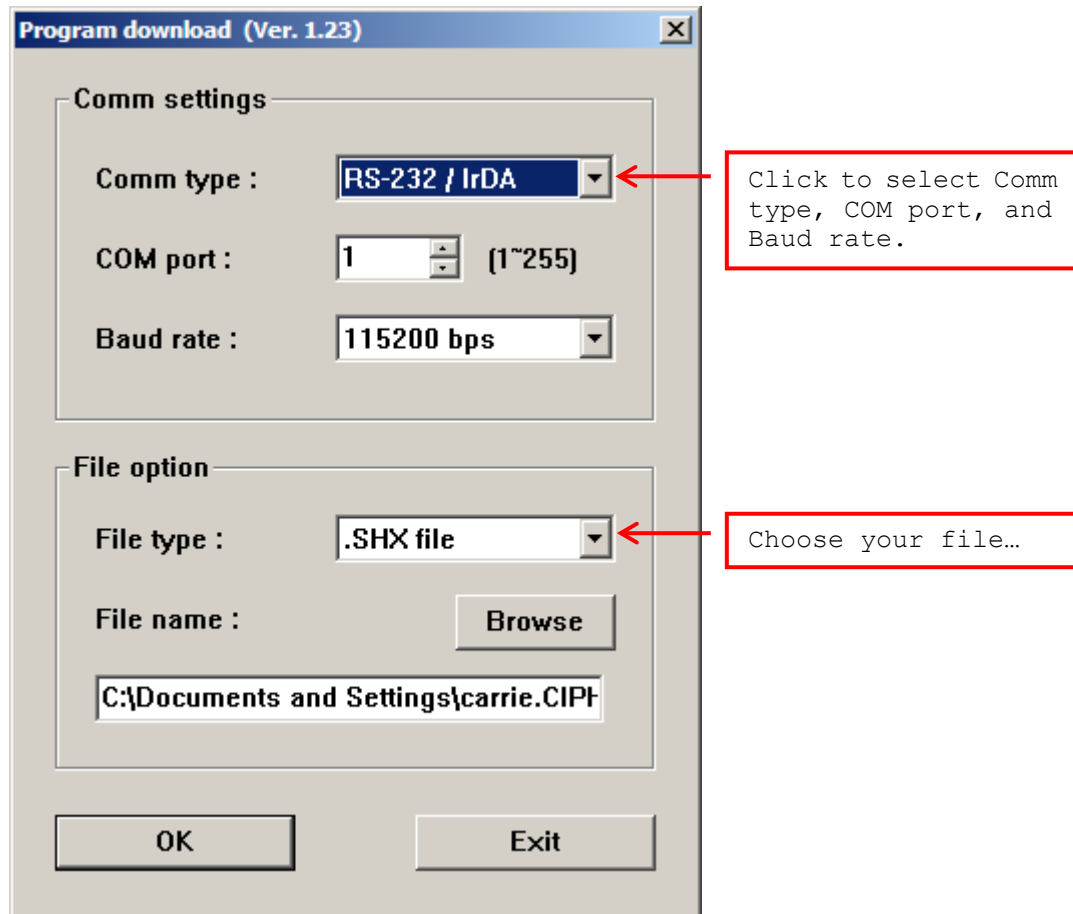

Communication Type

| | |
|-------------|---|
| RS-232/IrDA | Connection via direct RS-232 cable, IrDA port, or Bluetooth SPP |
| Cradle-IR | Connection via cradle |
| TCP/IP | Connection over networks |

File Type

| | |
|-----------|---|
| .SHX file | Any C program, such as AG Runtime, Basic Runtime, font file, etc. |
| .SYN file | Any Basic program after Basic Runtime has been installed first. |

TROUBLESHOOTING

CANNOT TURN ON WHEN PRESSING POWER KEY

- ▶ Make sure the battery pack is installed properly.
- ▶ Re-charge the battery inside the mobile computer and monitor the charging status. (See [3.5 Power.](#))
- ▶ If the battery is faulty, replace it with a fresh and fully charged battery then.

CHARGING ERROR

- ▶ If using a cradle or charger, make sure the power cord is well connected the cradle/charger and an outlet.
- ▶ Check if the battery contacts of the battery itself and the battery compartment are clean.
- ▶ Try to re-charge the battery and monitor the charging status.

Warning! Only use batteries or charging device manufactured by CipherLab. The use of wrong battery or charging device could result in damage to human body or the product itself, and will void your warranty.

BUZZER SEEMS NOT WORKING

- ▶ Perform the buzzer test. (See [3.3.2 Buzzer.](#))
- ▶ If the problem persists, reload the battery pack and perform the test again.

LED INDICATOR SEEMS NOT WORKING

- ▶ Perform the LCD & LED test. (See [3.3.3 LCD & LED.](#))
- ▶ If the problem persists, reload the battery pack and perform the test again.

LCD TOUCH SCREEN SEEMS NOT WORKING

- ▶ Perform the touch screen test. (See [3.3.6 Touch Screen.](#))
- ▶ If the problem persists, reload the battery pack and perform the test again.

KEYPAD SEEMS NOT WORKING

- ▶ Perform the keyboard test. (See [3.3.4 Keyboard.](#))
- ▶ If the problem persists, reload the battery pack and perform the test again.

VIBRATOR SEEMS NOT WORKING

- ▶ Perform the vibrator test. (See [3.3.7 Vibrator.](#))
- ▶ If the problem persists, reload the battery pack and perform the test again.

MOBILE COMPUTER SEEMS NOT WORKING

- ▶ Upload all data to the host and perform the memory test. (See [3.3.5 Memory.](#))
- ▶ If the problem persists, reload the battery pack and perform the test again.

CANNOT SCAN BARCODES

LOW BATTERY CONDITION

- ▶ Check if the battery icon on the screen indicates a low battery status. If so, replace it with a fresh battery then.
- ▶ If the problem persists, check if the battery contacts get dirty or the battery pack does not fit to the compartment.

BARCODE OR RFID READER PROBLEM

- ▶ Perform the reader test to see if the reader is working. (See [3.3.1 Reader](#) or [3.3.9 RFID.](#))
- ▶ If the problem persists, reload the battery pack and perform the test again.

CANNOT DECODE DATA AFTER SCANNING

UNREADABLE BARCODE

- ▶ Check if the barcode is defaced. A defaced barcode may not be readable.

UN-PROGRAMMED TO READ

- ▶ Check if the scanner is programmed to read the symbologies (types of barcode) that you are trying to read.
- ▶ Try scanning a test barcode of the symbology you are trying to read.

DIRTY SCAN WINDOW

- ▶ Check if the scan window gets dirty. Wipe it with a clean and dry cloth, and try again.

OUT OF SCANNING RANGE

- ▶ Try adjusting the scanning distance from the scanner to the barcode.

CANNOT TRANSMIT/RECEIVE DATA

VIA IR PORT

- ▶ Make sure the mobile computer's infrared port is pointed directly to the infrared port of another IR device.
- ▶ Make sure the distance between the mobile computer and a target device is within proper range, and no obstacles in between. Try to establish connection again.
- ▶ If the problem persists, run the Echo Test to check if the IR interface between the mobile computer and the cradle is working. (See [3.3.8 Echo Test](#).)

USING RS-232 CABLE VIA CRADLE

- ▶ Check if the RS-232 connection is correct and secured.
- ▶ Make sure the serial port parameters on the host are configured to match the serial parameters on the mobile computer. Try to establish connection again.
- ▶ Make sure the mobile computer is well seated inside the cradle. DO NOT remove the mobile computer or disconnect the cradle before communications are done.
- ▶ If the problem persists, run the Echo Test to check if the IR interface between the mobile computer and the cradle is working. (See [3.3.8 Echo Test](#).)

VIA BLUETOOTH

- ▶ Make sure the distance between the mobile computer and a target device is within proper range. Try to establish connection again.
- ▶ Check if the relevant settings are correct. (See [3.7 Bluetooth Menu](#).)
- ▶ If the problem persists, run the Echo Test to check if the connection is working properly. (See [3.7.4 Echo Tests](#).)

VIA WI-FI

- ▶ Make sure the mobile computer is connected to an access point properly, under the same SSID. Try to establish connection again.
- ▶ Check if the relevant settings are correct. (See [3.10 Wi-Fi Menu](#).)
- ▶ If the problem persists, run the Echo Test to check if the connection is working properly. (See [3.10.5 Echo Tests](#).)

VIA ETHERNET CRADLE

- ▶ Check if the Ethernet connection is correct and secured.
- ▶ Make sure the networking parameters are configured properly. Try to establish connection again.
- ▶ Make sure the mobile computer is well seated inside the cradle. DO NOT remove the mobile computer or disconnect the cradle before communications are done.
- ▶ If the problem persists, run the Echo Test to check if the Ethernet connection is working properly. (See [3.9.3 Echo Tests](#).)

VIA MODEM CRADLE

- ▶ Check if the modem connection is correct and secured.
- ▶ Make sure the modem parameters are configured properly. Try to establish connection again.
- ▶ Make sure the mobile computer is well seated inside the cradle. DO NOT remove the mobile computer or disconnect the cradle before communications are done.
- ▶ If the problem persists, run the Echo Test to check if the PPP connection is working properly. (See [3.8.3 Echo Test.](#))
- ▶ If the problem persists, run the Echo Test to check if the IR/MODEM interface between the mobile computer and the cradle is working. (See [3.3.8 Echo Test.](#))

KEY REFERENCE TABLES

24-KEY KEYPAD

SYSTEM DEFAULTS

| Key | [ALPHA] key pressed once | [ALPHA] key pressed twice | Key | [FN] pressed once | [FN] pressed twice |
|-----|--------------------------------|---------------------------------|-----|-------------------------|--------------------------|
| 1 | Space | Space | 1 | F1 | 1 |
| 2 | ABC | abc | 2 | F2 | 2 |
| 3 | DEF | def | 3 | F3 | 3 |
| 4 | GHI | ghi | 4 | F4 | 4 |
| 5 | JKL | jkl | 5 | F5 | 5 |
| 6 | MNO | mno | 6 | F6 | 6 |
| 7 | PQRS | pqrs | 7 | F7 | 7 |
| 8 | TUV | tuv | 8 | F8 | 8 |
| 9 | WXYZ | wxyz | 9 | F9 | 9 |
| - | +\$ | +\$ | - | - | - |
| 0 | /* | /* | 0 | F10 | 0 |
| . | %#;, | %#;, | . | . | . |

44-KEY KEYPAD

SYSTEM DEFAULTS

| Key | [Shift] key pressed once | [Shift] key pressed twice | Key | Red key pressed once / held down |
|-----|--------------------------|---------------------------|------|----------------------------------|
| AB | ab | AB | AB | F1 |
| CD | cd | CD | CD | F2 |
| EF | ef | EF | EF | F3 |
| GH | gh | GH | GH | F4 |
| IJ | ij | IJ | IJ | F5 |
| KL | kl | KL | KL | F6 |
| MN | mn | MN | MN | F7 |
| OP | op | OP | OP | F8 |
| QR | qr | QR | QR | F9 |
| ST | st | ST | ST | F10 |
| UV | uv | UV | UV | F11 |
| WX | wx | WX | WX | F12 |
| YZ | yz | YZ | YZ | #? |
| | | | ,; | +/ |
| | | | \$_: | *\ |

44-TE KEY KEYPAD

SYSTEM DEFAULTS

| Key | [Alpha] key pressed once | [Alpha] key pressed twice | Key | Blue key pressed once |
|-----|--------------------------|---------------------------|-----|-----------------------|
| 1 | A | a | 1 | ^ |
| 2 | B | b | 2 | & |
| 3 | C | c | 3 | ⓪+ |
| 4 | D | d | 4 | [|
| 5 | E | e | 5 |] |
| 6 | F | f | 6 | ⓪- |
| 7 | G | g | 7 | < |
| 8 | H | h | 8 | > |
| 9 | I | i | 9 | ? |
| - | J | j | - | \$ |
| 0 | K | k | 0 | % |
| . | L | l | . | # |

| Key | [Alpha] key pressed once | [Alpha] key pressed twice | Key | Blue key pressed once |
|-----|--------------------------|---------------------------|-----|-----------------------|
| F1 | M | m | F1 | + |
| F2 | N | n | F2 | - |
| F3 | O | o | F3 | * |
| F4 | P | p | F4 | / |
| F5 | Q | q | F5 | = |
| F6 | R | r | F6 | F16 |
| F7 | S | s | F7 | F17 |
| F8 | T | t | F8 | F18 |
| F9 | U | u | F9 | F19 |
| F10 | V | v | F10 | F20 |
| F11 | W | w | F11 | F21 |
| F12 | X | x | F12 | F22 |
| F13 | Y | y | F13 | F23 |
| F14 | Z | z | F14 | F24 |
| F15 | null | null | F15 | null |